

**3A NPN Epitaxial Planar Power Transistor**

# TIP31CE3

**Description**

TIP31CE3 is designed for use in general purpose amplifier and switching applications.

**Features**

- Low collector-emitter saturation voltage,  $V_{CE(sat)} = 1.2V(max) @ I_C = 3A$
- High collector-emitter sustaining voltage,  $BV_{CEO(SUS)} = 100V(min)$
- High current gain-bandwidth product ,  $f_T = 3MHz(min) @ I_C = 500mA$

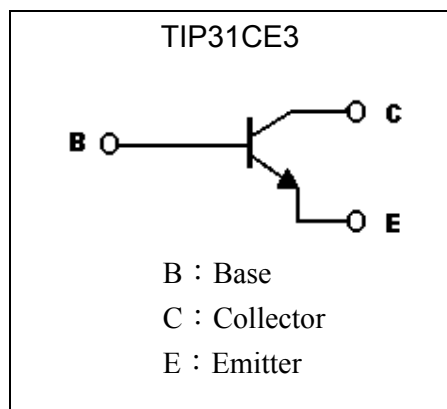
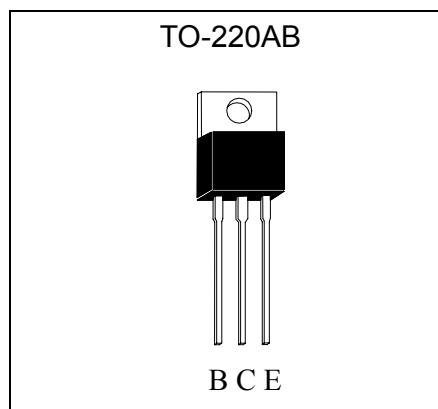
**Symbol**

**Outline**

**Absolute Maximum Ratings** ( $T_a=25^{\circ}C$ )

Parameter	Symbol	Limits	Unit
Collector-Base Voltage	$V_{CBO}$	100	V
Collector-Emitter Voltage	$V_{CEO}$	100	V
Emitter-Base Voltage	$V_{EBO}$	5	V
Collector Current (DC)	$I_C$	3	A
Collector Current (Pulse)	$I_{CP}$	5 (Note 1)	
Base Current	$I_B$	1	A
Power Dissipation @ $T_A=25^{\circ}C$	$P_D$	2	W
Power Dissipation @ $T_C=25^{\circ}C$	$P_D$	40	
Thermal Resistance, Junction to Ambient	$R_{\theta JA}$	62.5	$^{\circ}C/W$
Thermal Resistance, Junction to Case	$R_{\theta JC}$	3.125	$^{\circ}C/W$
Junction Temperature	$T_j$	150	$^{\circ}C$
Storage Temperature	$T_{stg}$	-55~+150	$^{\circ}C$

Note : 1. Single Pulse ,  $P_w \leq 380\mu s$ , Duty  $\leq 2\%$ .

**Characteristics** (Ta=25°C)

Symbol	Min.	Typ.	Max.	Unit	Test Conditions
*BV <sub>CEO(SUS)</sub>	100	-	-	V	I <sub>C</sub> =30mA, I <sub>B</sub> =0
I <sub>CEO</sub>	-	-	300	μA	V <sub>CE</sub> =60V, I <sub>B</sub> =0
I <sub>CES</sub>	-	-	200	μA	V <sub>CE</sub> =100V, V <sub>BE</sub> =0
I <sub>EBO</sub>	-	-	1	mA	V <sub>EB</sub> =5V, I <sub>C</sub> =0
*V <sub>CE(sat)</sub>	-	-	1.2	V	I <sub>C</sub> =3A, I <sub>B</sub> =375mA
*V <sub>BE(on)</sub>	-	-	1.8	V	V <sub>CE</sub> =4V, I <sub>C</sub> =3A
*h <sub>FE</sub>	25	-	-	-	V <sub>CE</sub> =4V, I <sub>C</sub> =1A
*h <sub>FE</sub>	10	-	50	-	V <sub>CE</sub> =4V, I <sub>C</sub> =3A
f <sub>T</sub>	3	-	-	MHz	V <sub>CE</sub> =10V, I <sub>C</sub> =500mA, f=1MHz

\*Pulse Test : Pulse Width ≤380μs, Duty Cycle≤2%



### Characteristic Curves

Current Gain vs Collector Current

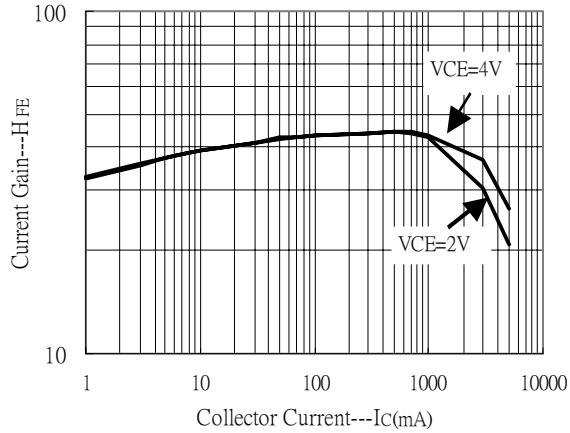

Saturation Voltage vs Collector Current

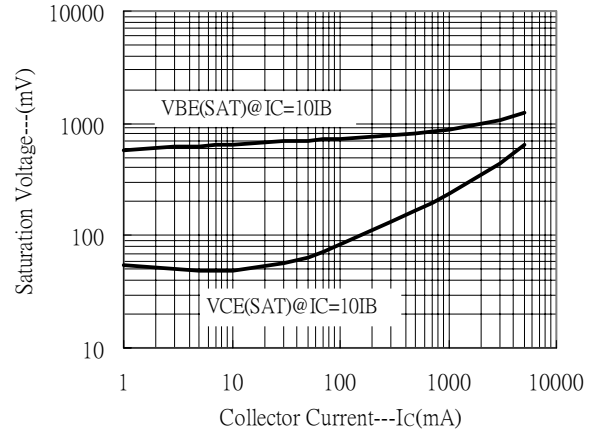

ON Voltage vs Collector Current

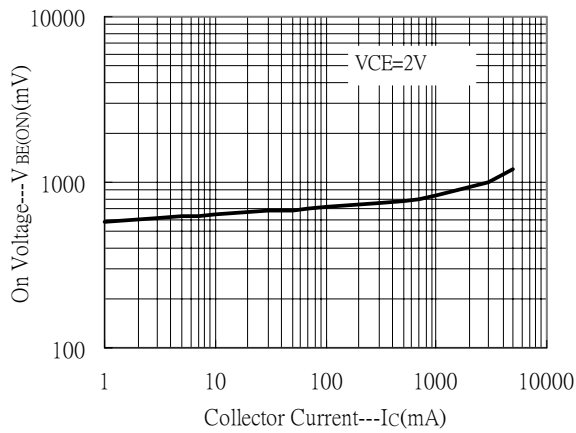

Power Derating Curve

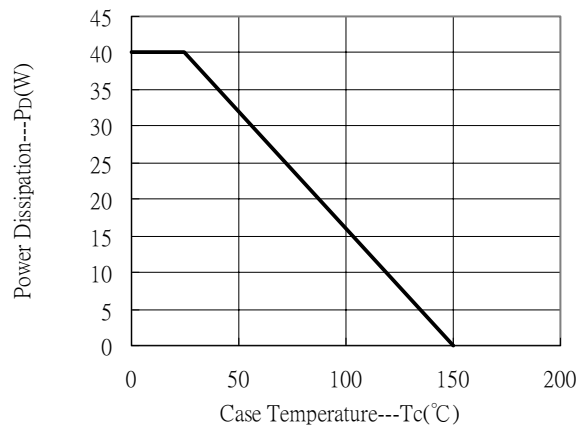

Power Derating Curve

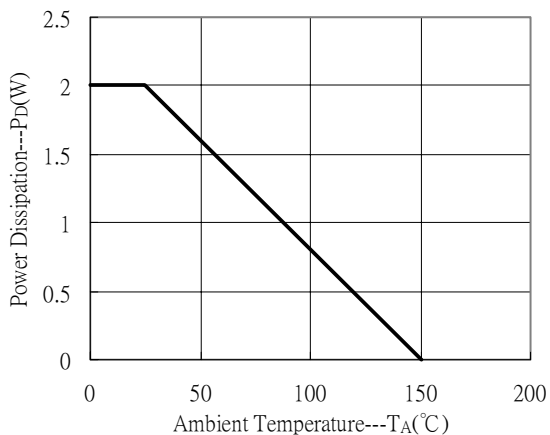

**TO-220AB Dimension**

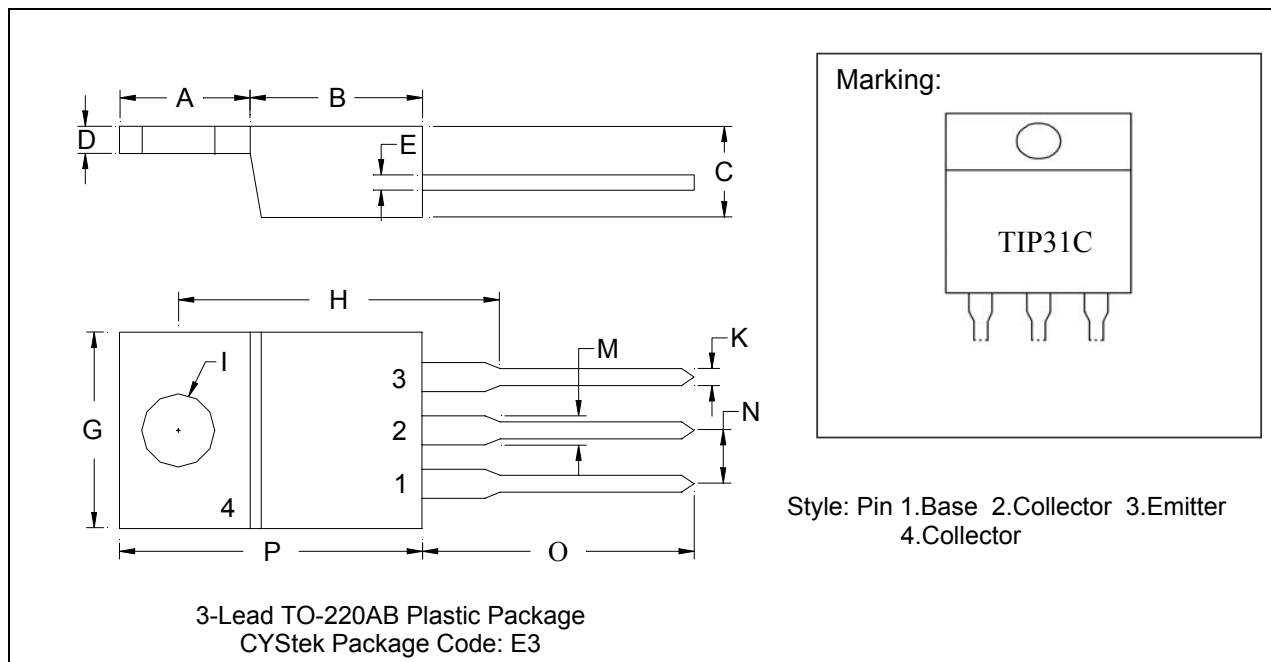

\*: Typical

DIM	Inches		Millimeters		DIM	Inches		Millimeters	
	Min.	Max.	Min.	Max.		Min.	Max.	Min.	Max.
A	0.2197	0.2949	5.58	7.49	I	-	*0.1508	-	*3.83
B	0.3299	0.3504	8.38	8.90	K	0.0295	0.0374	0.75	0.95
C	0.1732	0.185	4.40	4.70	M	0.0449	0.0551	1.14	1.40
D	0.0453	0.0547	1.15	1.39	N	-	*0.1000	-	*2.54
E	0.0138	0.0236	0.35	0.60	O	0.5000	0.5618	12.70	14.27
G	0.3803	0.4047	9.66	10.28	P	0.5701	0.6248	14.48	15.87
H	-	*0.6398	-	*16.25					

- Notes:** 1.Controlling dimension: millimeters.  
 2.Maximum lead thickness includes lead finish thickness, and minimum lead thickness is the minimum thickness of base material.  
 3.If there is any question with packing specification or packing method, please contact your local CYStek sales office.

**Material:**

- Lead: 42 Alloy ; solder plating
- Mold Compound: Epoxy resin family, flammability solid burning class: UL94V-0

**Important Notice:**

- All rights are reserved. Reproduction in whole or in part is prohibited without the prior written approval of CYStek.
- CYStek reserves the right to make changes to its products without notice.
- CYStek **semiconductor products are not warranted to be suitable for use in Life-Support Applications, or systems.**
- CYStek assumes no liability for any consequence of customer product design, infringement of patents, or application assistance.