

The RF Line
NPN Silicon
Low Noise Transistors

Motorola's MRF959 is a high performance silicon NPN transistor designed for use in high gain, low noise small-signal amplifiers. The MRF959 is well suited for low voltage applications. This device features a 9 GHz DC current gain-bandwidth product with excellent linearity.

- Low Noise Figure, $NF_{min} = 1.3$ dB (Typ) @ 1 GHz @ 5 mA
- High Current Gain-Bandwidth Product, $f_t = 9$ GHz @ 30 mA
- Maximum Available Gain, $MAG = 17$ dB (Typ) @ 1 GHz @ 15 mA
- Output Third Order Intercept, $OIP_3 = +30$ dBm @ 1 GHz @ 30 mA
- Fully Ion-Implanted with Gold Metallization and Nitride Passivation
- Available in Tape and Reel Packaging Options:
T1 Suffix = 3,000 Units per Reel

MRF959T1 **$I_{Cmax} = 100$ mA**
LOW NOISE
TRANSISTORS**CASE 463-01, STYLE 1**
(SC-90)**MAXIMUM RATINGS**

Rating	Symbol	Value	Unit
Collector-Emitter Voltage	V_{CEO}	10	Vdc
Collector-Base Voltage	V_{CBO}	20	Vdc
Emitter-Base Voltage	V_{EBO}	1.5	Vdc
Power Dissipation (1) $T_C = 75^\circ\text{C}$ Derate linearly above $T_C = 75^\circ\text{C}$ @	P_{Dmax}	0.150 2	Watts mW/ $^\circ\text{C}$
Collector Current — Continuous (2)	I_C	100	mA
Maximum Junction Temperature	T_{Jmax}	150	$^\circ\text{C}$
Storage Temperature	T_{stg}	-55 to +150	$^\circ\text{C}$
Thermal Resistance, Junction to Case	$R_{\theta JC}$	500	$^\circ\text{C}/\text{W}$

DEVICE MARKINGS

MRF959T1 = V1

(1) To calculate the junction temperature use $T_J = (P_D \times R_{\theta JC}) + T_C$. The case temperature is measured on collector lead adjacent to the package body.

(2) I_C — Continuous (MTBF > 10 years).

ELECTRICAL CHARACTERISTICS ($T_A = 25^\circ\text{C}$ unless otherwise noted)

Characteristic	Symbol	Min	Typ	Max	Unit
OFF CHARACTERISTICS (3)					
Collector–Emitter Breakdown Voltage ($I_C = 0.1\text{ mA}$, $I_B = 0$)	$V_{(BR)CEO}$	10	13	—	Vdc
Collector–Base Breakdown Voltage ($I_C = 0.1\text{ mA}$, $I_E = 0$)	$V_{(BR)CBO}$	20	25	—	Vdc
Emitter Cutoff Current ($V_{EB} = 1\text{ V}$, $I_C = 0$)	I_{EBO}	—	—	0.1	μA
Collector Cutoff Current ($V_{CB} = 10\text{ V}$, $I_E = 0$)	I_{CBO}	—	—	0.1	μA

ON CHARACTERISTICS (3)

DC Current Gain ($V_{CE} = 6\text{ V}$, $I_C = 5\text{ mA}$)	h_{FE}	75	—	150	—
---	----------	----	---	-----	---

DYNAMIC CHARACTERISTICS

Collector–Base Capacitance ($V_{CB} = 1\text{ V}$, $I_E = 0$, $f = 1\text{ MHz}$) ($V_{CB} = 5\text{ V}$, $I_E = 0$, $f = 1\text{ MHz}$)	C_{cb}	— —	0.63 0.44	— —	pF
Current Gain — Bandwidth Product ($V_{CE} = 6\text{ V}$, $I_C = 30\text{ mA}$, $f = 1\text{ GHz}$)	f_T	—	9	—	GHz

PERFORMANCE CHARACTERISTICS

Conditions	Symbol	Min	Typ	Max	Unit
Insertion Gain ($V_{CE} = 1\text{ V}$, $I_C = 1\text{ mA}$, $f = 1\text{ GHz}$) ($V_{CE} = 6\text{ V}$, $I_C = 15\text{ mA}$, $f = 1\text{ GHz}$)	$ S_{21} ^2$	— —	4 14	— —	dB
Maximum Unilateral Gain (4) ($V_{CE} = 1\text{ V}$, $I_C = 1\text{ mA}$, $f = 1\text{ GHz}$) ($V_{CE} = 6\text{ V}$, $I_C = 15\text{ mA}$, $f = 1\text{ GHz}$)	G_{Umax}	— —	9 15	— —	dB
Maximum Stable Gain and/or Maximum Available Gain (5) ($V_{CE} = 1\text{ V}$, $I_C = 1\text{ mA}$, $f = 1\text{ GHz}$) ($V_{CE} = 6\text{ V}$, $I_C = 15\text{ mA}$, $f = 1\text{ GHz}$)	MSG MAG	— —	10 17	— —	dB
Noise Figure — Minimum ($V_{CE} = 1\text{ V}$, $I_C = 1\text{ mA}$, $f = 1\text{ GHz}$) ($V_{CE} = 6\text{ V}$, $I_C = 5\text{ mA}$, $f = 1\text{ GHz}$)	NF_{min}	— —	1.6 1.3	— —	dB
Noise Resistance ($V_{CE} = 1\text{ V}$, $I_C = 1\text{ mA}$, $f = 1\text{ GHz}$) ($V_{CE} = 6\text{ V}$, $I_C = 5\text{ mA}$, $f = 1\text{ GHz}$)	R_N	— —	14 9	— —	Ω
Associated Gain at Minimum NF ($V_{CE} = 1\text{ V}$, $I_C = 1\text{ mA}$, $f = 1\text{ GHz}$) ($V_{CE} = 6\text{ V}$, $I_C = 5\text{ mA}$, $f = 1\text{ GHz}$)	G_{NF}	— —	8 13	— —	dB
Output Power at 1 dB Gain Compression (6) ($V_{CE} = 6\text{ V}$, $I_C = 15\text{ mA}$, $f = 1\text{ GHz}$)	P_{1dB}	—	+12	—	dBm
Output Third Order Intercept (6) ($V_{CE} = 6\text{ V}$, $I_C = 15\text{ mA}$, $f = 1\text{ GHz}$)	OIP_3	—	+26	—	dBm

(3) Pulse width $\leq 300\ \mu\text{s}$, duty cycle $\leq 2\%$ pulsed.(4) Maximum unilateral gain is $G_{Umax} = \frac{|S_{21}|^2}{(1-|S_{11}|^2)(1-|S_{22}|^2)}$ (5) Maximum available gain and maximum stable gain are defined by the K factor as follows: $MAG = \frac{|S_{21}|}{|S_{12}|} (K \pm \sqrt{K^2 - 1})$, if $K > 1$ (6) $Z_{in} = 50\ \Omega$ and Z_{out} matched for small signal maximum gain.

$$MSG = \frac{|S_{21}|}{|S_{12}|}, \text{ if } K < 1$$

TYPICAL CHARACTERISTICS

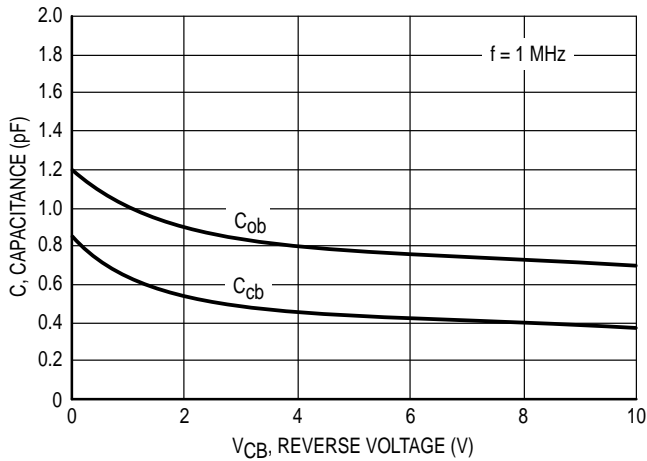

Figure 1. Capacitance versus Voltage

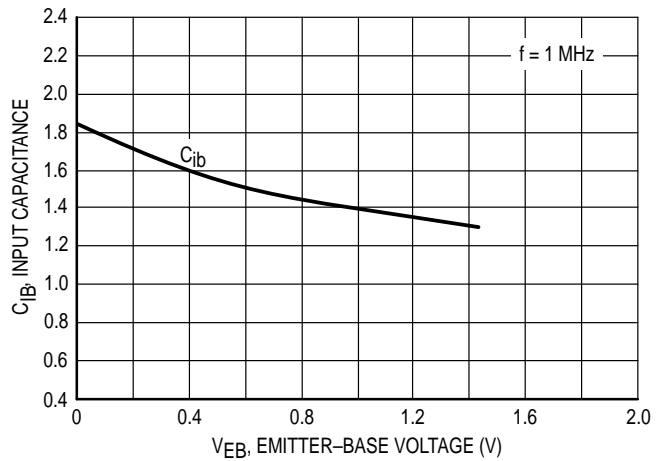

Figure 2. Input Capacitance versus Voltage

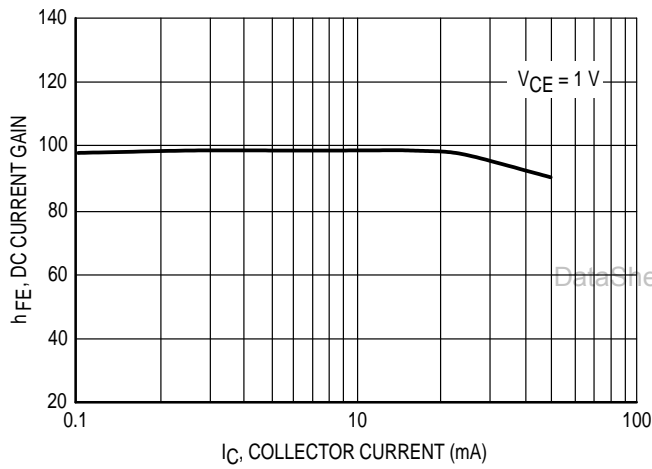

Figure 3. DC Current Gain versus Collector Current

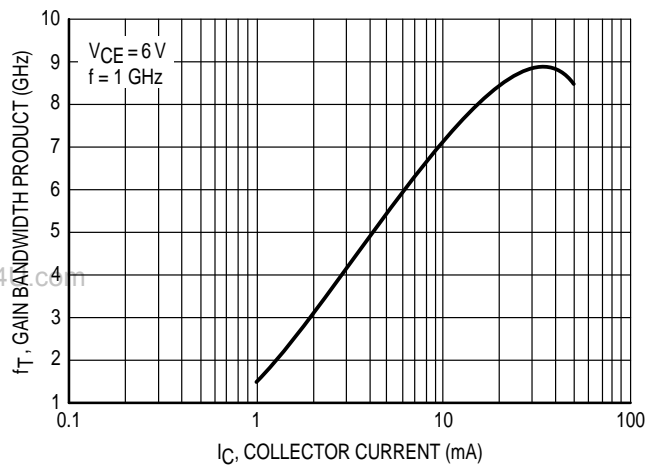

Figure 4. Gain-Bandwidth Product versus Collector Current

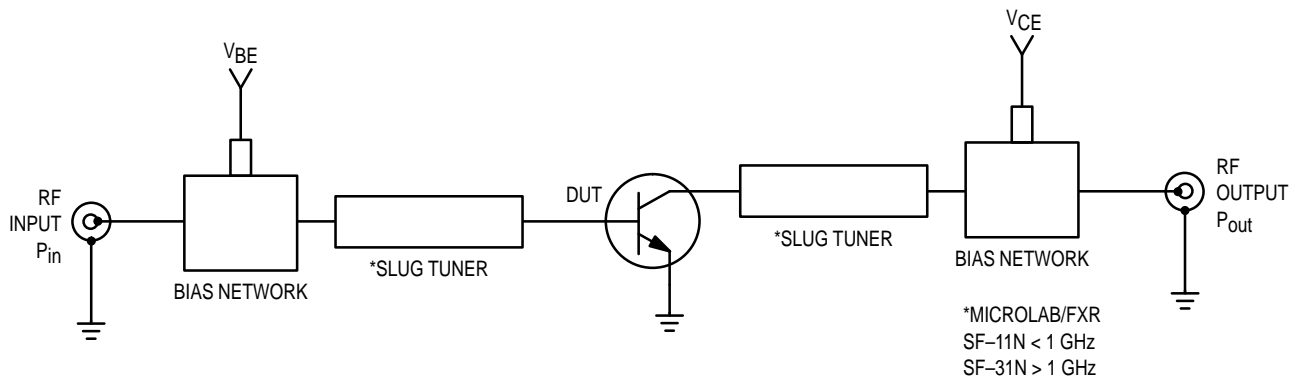

Figure 5. Functional Circuit Schematic

TYPICAL CHARACTERISTICS

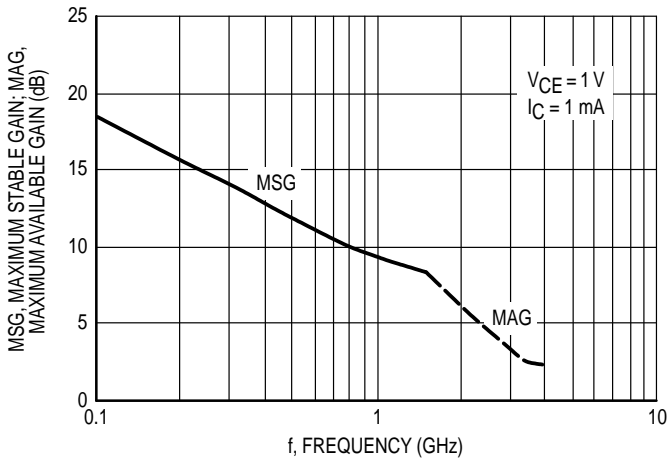

Figure 6. Maximum Stable/Available Gain versus Frequency

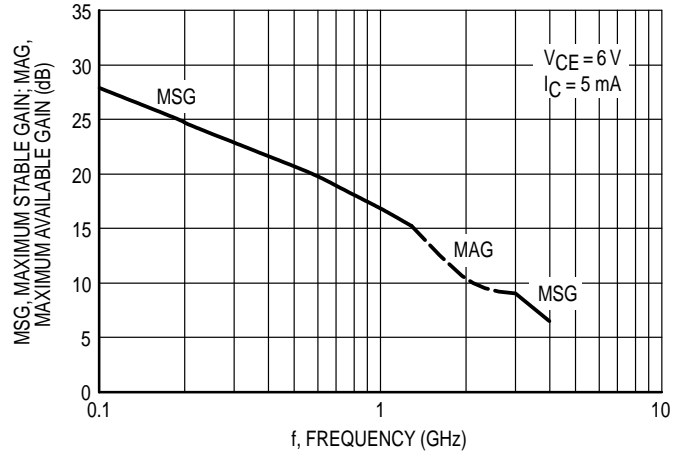

Figure 7. Maximum Stable/Available Gain versus Frequency

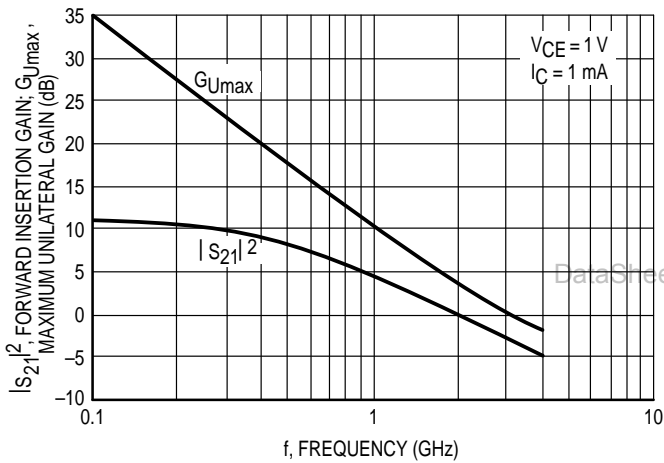

Figure 8. Maximum Unilateral Gain and Forward Insertion Gain versus Frequency

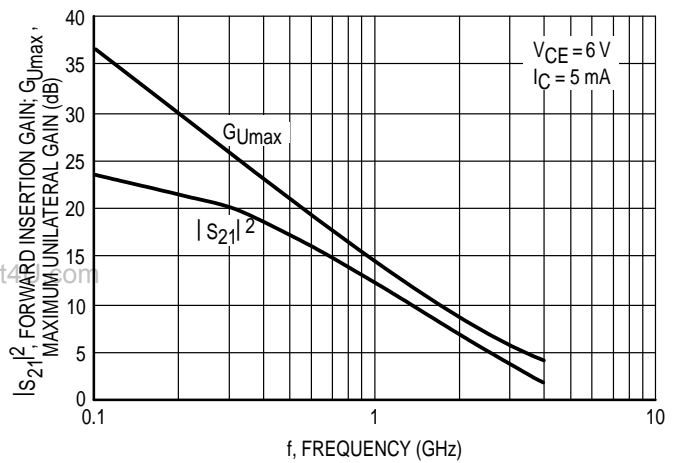

Figure 9. Maximum Unilateral Gain and Forward Insertion Gain versus Frequency

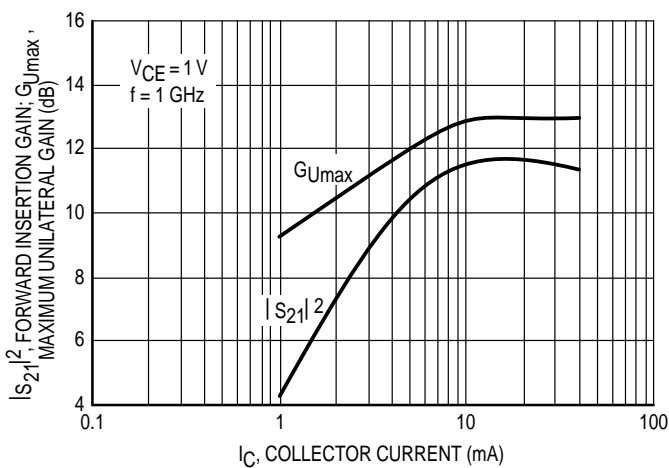

Figure 10. Maximum Unilateral Gain and Forward Insertion Gain versus Collector Current

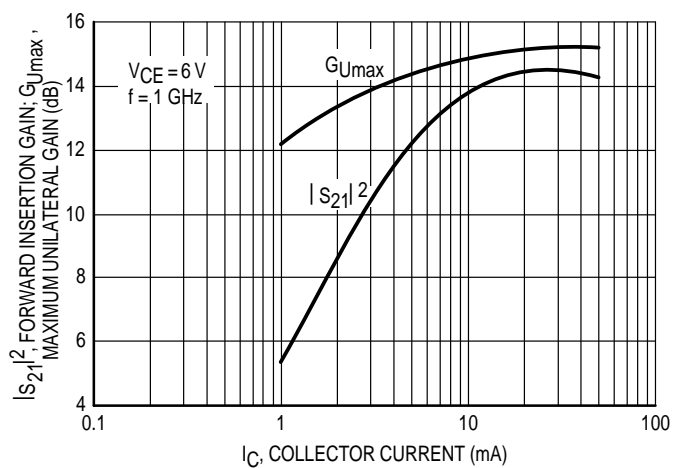

Figure 11. Maximum Unilateral Gain and Forward Insertion Gain versus Collector Current

TYPICAL CHARACTERISTICS

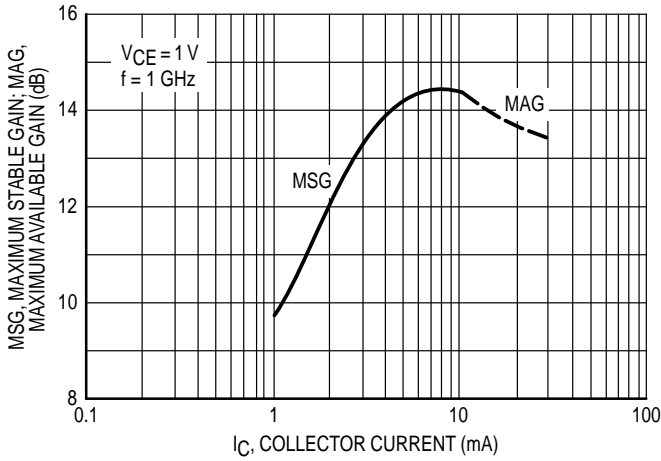

Figure 12. Maximum Stable/Available Gain versus Collector Current

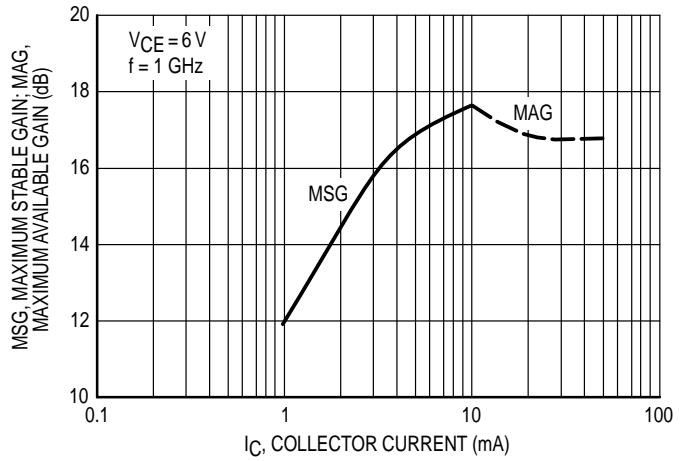

Figure 13. Maximum Stable/Available Gain versus Collector Current

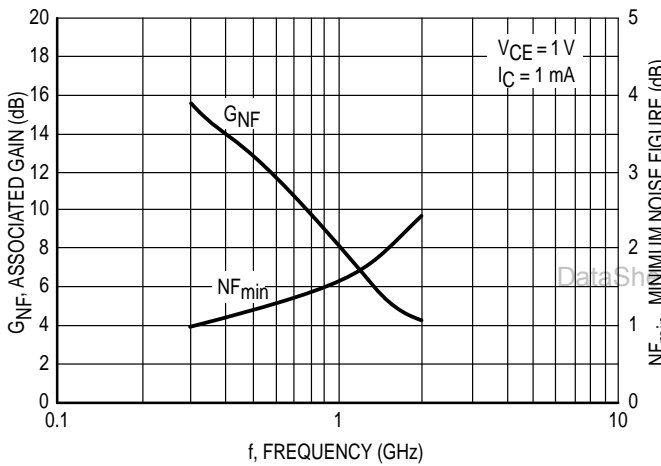

Figure 14. Minimum Noise Figure and Associated Gain versus Frequency

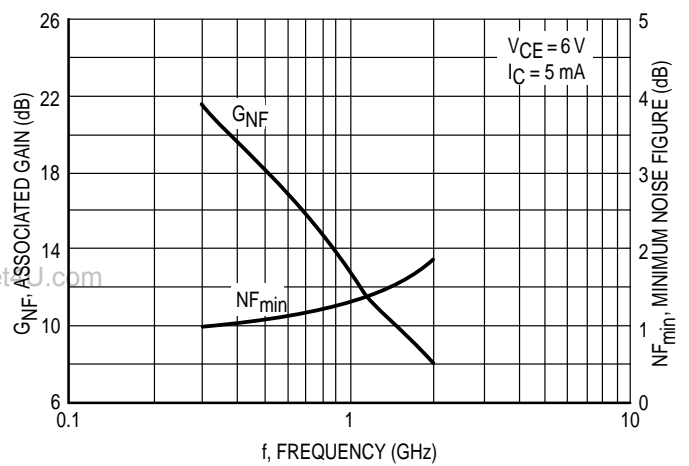

Figure 15. Minimum Noise Figure and Associated Gain versus Frequency

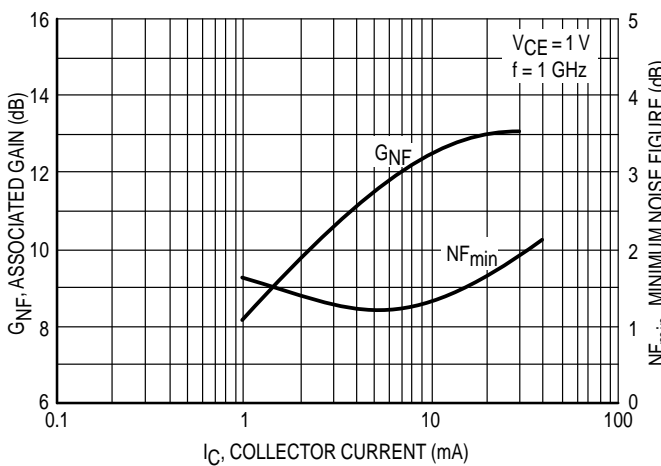

Figure 16. Minimum Noise Figure and Associated Gain versus Collector Current

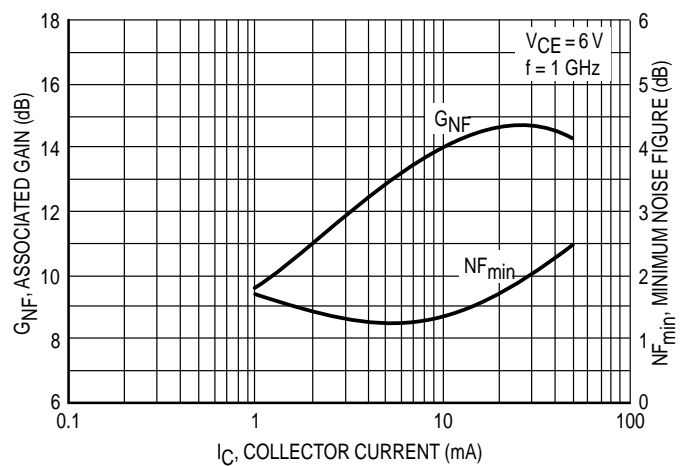

Figure 17. Minimum Noise Figure and Associated Gain versus Collector Current

TYPICAL CHARACTERISTICS

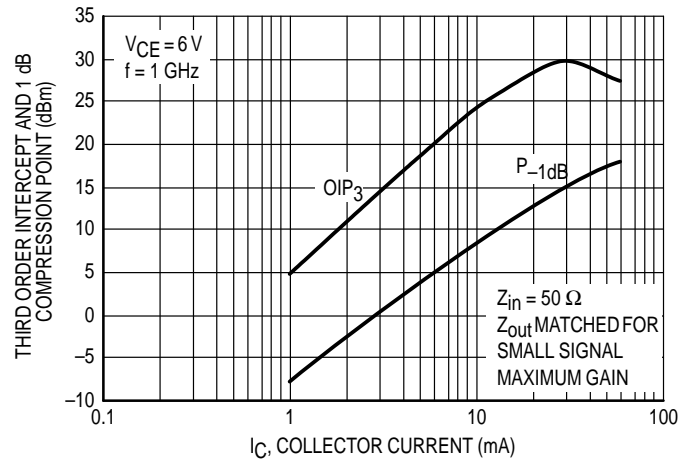

Figure 18. Output Third Order Intercept and Output Power at 1 dB Gain Compression versus Collector Current

$V_{CE} = 1\text{ V}$
 $I_C = 1\text{ mA}$

f (GHz)	NF OPT	Γ_O	R_N	K
1.0	1.61 dB	$0.53 \angle 111.4^\circ$	14	0.53

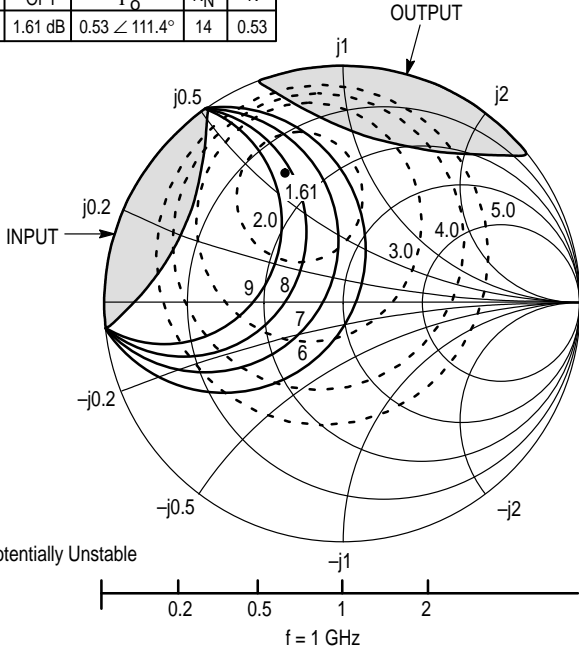

Figure 19. MRF959T1 Series Constant Gain and Noise Figure Contours

$V_{CE} = 1\text{ V}$
 $I_C = 1\text{ mA}$

f (GHz)	NF OPT	Γ_O	R_N	K
2.0	2.39 dB	$0.64 \angle 174.6^\circ$	4	1.12

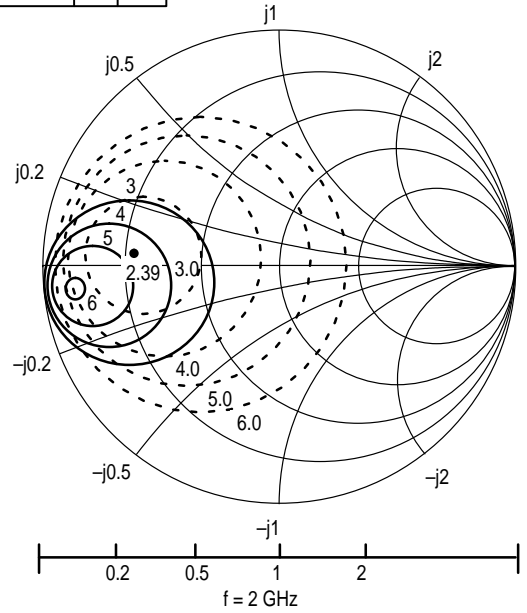

Figure 20. MRF959T1 Series Constant Gain and Noise Figure Contours

$V_{CE} = 3\text{ V}$
 $I_C = 3\text{ mA}$

f (GHz)	NF OPT	Γ_O	R_N	K
1.0	1.29 dB	$0.37 \angle 108.0^\circ$	9	0.73

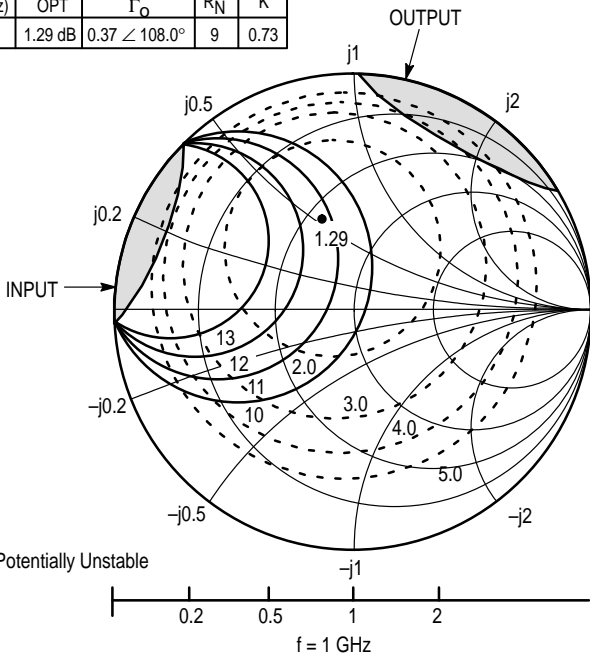

Figure 21. MRF959T1 Series Constant Gain and Noise Figure Contours

$V_{CE} = 6\text{ V}$
 $I_C = 5\text{ mA}$

f (GHz)	NF OPT	Γ_O	R_N	K
1.0	1.3 dB	$0.31 \angle 104.0^\circ$	8.5	0.88

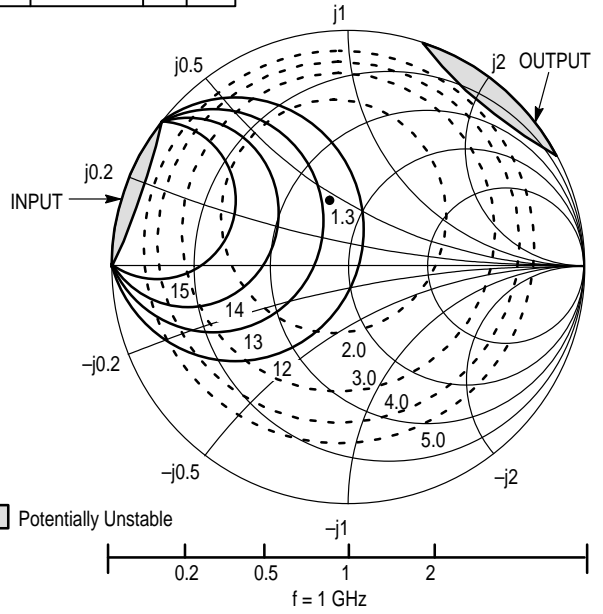

Figure 22. MRF959T1 Series Constant Gain and Noise Figure Contours

V _{CE} (Vdc)	I _C (mA)	f (GHz)	S ₁₁		S ₂₁		S ₁₂		S ₂₂		
			S ₁₁	∠φ	S ₂₁	∠φ	S ₁₂	∠φ	S ₂₂	∠φ	
1.0	1.0	0.1	0.946	-21	3.53	165	0.047	78	0.980	-9	
		0.3	0.888	-60	3.08	139	0.122	56	0.889	-24	
		0.5	0.801	-89	2.49	118	0.160	41	0.778	-32	
		0.7	0.748	-111	2.06	102	0.177	30	0.698	-39	
		0.9	0.711	-128	1.74	90	0.183	24	0.646	-45	
		1.0	0.700	-135	1.62	85	0.182	21	0.629	-47	
		1.3	0.688	-153	1.33	72	0.174	17	0.591	-54	
		1.5	0.682	-163	1.18	64	0.166	15	0.579	-59	
		2.0	0.680	179	0.94	49	0.141	21	0.571	-73	
		2.5	0.702	163	0.77	37	0.135	39	0.568	-90	
		3.0	0.713	152	0.67	30	0.172	56	0.582	-104	
		3.5	0.712	138	0.59	26	0.235	62	0.596	-118	
		4.0	0.727	127	0.55	25	0.312	60	0.603	-132	
		4.5	0.710	117	0.54	24	0.393	55	0.602	-145	
		5.0	0.705	108	0.55	23	0.463	48	0.598	-160	
	3.0	3.0	0.1	0.850	-34	9.36	158	0.044	72	0.934	-18
			0.3	0.736	-86	6.84	126	0.096	49	0.707	-42
			0.5	0.640	-117	4.86	107	0.115	39	0.532	-51
			0.7	0.606	-137	3.74	95	0.123	35	0.436	-56
			0.9	0.584	-151	3.01	86	0.129	35	0.385	-61
			1.0	0.578	-156	2.76	82	0.132	35	0.370	-63
			1.3	0.581	-170	2.20	72	0.140	37	0.331	-68
			1.5	0.580	-178	1.93	66	0.146	39	0.321	-73
			2.0	0.581	168	1.51	53	0.167	45	0.315	-85
			2.5	0.611	156	1.25	42	0.195	50	0.316	-101
			3.0	0.619	147	1.09	33	0.237	53	0.336	-113
			3.5	0.621	135	0.96	26	0.285	53	0.358	-124
			4.0	0.645	127	0.87	20	0.338	51	0.381	-136
			4.5	0.638	118	0.81	16	0.397	47	0.400	-147
			5.0	0.65	110	0.758	12	0.45	43	0.415	-160
5.0	5.0	0.1	0.650	-53	23.10	147	0.025	68	0.844	-27	
		0.3	0.535	-114	13.19	114	0.048	53	0.513	-50	
		0.5	0.474	-140	8.59	100	0.060	54	0.359	-52	
		0.7	0.465	-156	6.34	91	0.072	57	0.290	-53	
		0.9	0.459	-166	5.01	84	0.084	59	0.256	-55	
		1.0	0.456	-170	4.55	81	0.091	60	0.247	-56	
		1.3	0.467	180	3.56	74	0.112	62	0.220	-58	
		1.5	0.469	174	3.11	69	0.126	62	0.212	-61	
		2.0	0.473	163	2.40	59	0.162	62	0.203	-71	
		2.5	0.509	152	1.96	49	0.198	61	0.189	-86	
		3.0	0.514	146	1.69	41	0.237	58	0.202	-95	
		3.5	0.518	135	1.49	33	0.276	56	0.214	-105	
		4.0	0.544	129	1.35	26	0.316	53	0.230	-115	
		4.5	0.543	122	1.24	20	0.358	49	0.247	-123	
		5.0	0.568	114	1.14	14	0.398	45	0.255	-136	

Table 1. Common Emitter S-Parameters

V _{CE} (Vdc)	I _C (mA)	f (GHz)	S ₁₁		S ₂₁		S ₁₂		S ₂₂	
			S ₁₁	∠φ	S ₂₁	∠φ	S ₁₂	∠φ	S ₂₂	∠φ
3.0	3.0	0.1	0.866	-28	9.71	161	0.031	75	0.954	-13
		0.3	0.760	-76	7.57	131	0.072	54	0.782	-31
		0.5	0.653	-106	5.59	113	0.089	43	0.630	-37
		0.7	0.607	-127	4.37	100	0.097	39	0.541	-40
		0.9	0.578	-142	3.55	91	0.102	38	0.491	-43
		1.0	0.569	-148	3.26	87	0.105	38	0.475	-45
		1.3	0.566	-163	2.60	77	0.111	41	0.437	-48
		1.5	0.562	-172	2.28	71	0.116	43	0.425	-51
		2.0	0.561	173	1.77	58	0.131	50	0.411	-61
		2.5	0.588	160	1.45	47	0.155	56	0.396	-73
		3.0	0.598	151	1.26	38	0.190	60	0.406	-84
		3.5	0.603	139	1.10	30	0.233	61	0.419	-95
		4.0	0.629	130	0.98	23	0.282	60	0.433	-106
		4.5	0.626	122	0.90	18	0.338	57	0.447	-117
		5.0	0.644	113	0.83	13	0.394	53	0.452	-130
	5.0	0.1	0.792	-36	14.53	156	0.029	72	0.921	-18
		0.3	0.663	-90	10.09	124	0.062	52	0.676	-39
		0.5	0.566	-120	7.01	107	0.074	46	0.510	-43
		0.7	0.535	-139	5.32	96	0.083	45	0.425	-46
		0.9	0.517	-153	4.25	88	0.091	47	0.380	-48
		1.0	0.510	-158	3.89	84	0.096	48	0.367	-49
		1.3	0.515	-171	3.06	75	0.109	51	0.333	-52
		1.5	0.515	-178	2.69	70	0.118	53	0.322	-55
		2.0	0.516	169	2.08	58	0.146	56	0.310	-64
		2.5	0.548	156	1.70	48	0.176	58	0.294	-77
		3.0	0.556	149	1.47	39	0.213	59	0.306	-87
		3.5	0.559	137	1.29	31	0.253	58	0.319	-97
		4.0	0.587	130	1.16	24	0.296	56	0.334	-108
		4.5	0.586	122	1.06	18	0.345	53	0.351	-117
		5.0	0.608	114	0.98	12	0.393	49	0.358	-130
10.0	0.1	0.823	-24	14.80	161	0.018	77	0.952	-13	
	0.3	0.666	-63	11.47	131	0.045	60	0.790	-29	
	0.5	0.514	-87	8.47	113	0.058	53	0.653	-34	
	0.7	0.425	-108	6.60	100	0.069	51	0.577	-38	
	0.9	0.366	-124	5.37	91	0.078	50	0.532	-40	
	1.0	0.347	-132	4.91	86	0.083	50	0.512	-42	
	1.3	0.309	-152	3.91	75	0.098	50	0.479	-44	
	1.5	0.295	-163	3.44	70	0.108	49	0.465	-48	
	2.0	0.284	172	2.65	55	0.134	48	0.449	-55	
	2.5	0.277	151	2.18	43	0.161	45	0.442	-63	
	3.0	0.291	134	1.87	31	0.190	42	0.440	-71	
	3.5	0.298	118	1.63	20	0.221	37	0.441	-82	
	4.0	0.299	108	1.46	11	0.245	32	0.431	-92	
	4.5	0.343	96	1.35	1	0.278	29	0.430	-102	
	5.0	0.373	82	1.24	-8	0.313	23	0.436	-113	

Table 1. Common Emitter S-Parameters (continued)

V _{CE} (Vdc)	I _C (mA)	f (GHz)	S ₁₁		S ₂₁		S ₁₂		S ₂₂	
			S ₁₁	∠φ	S ₂₁	∠φ	S ₁₂	∠φ	S ₂₂	∠φ
6.0	5.0	0.1	0.809	-32	14.52	158	0.024	74	0.934	-15
		0.3	0.665	-83	10.44	126	0.053	55	0.721	-32
		0.5	0.550	-112	7.37	109	0.065	49	0.572	-35
		0.7	0.507	-132	5.63	98	0.074	49	0.493	-37
		0.9	0.482	-146	4.52	90	0.082	50	0.452	-38
		1.0	0.472	-152	4.12	86	0.086	51	0.440	-39
		1.3	0.471	-166	3.27	77	0.098	55	0.409	-41
		1.5	0.469	-174	2.87	72	0.108	57	0.398	-44
		2.0	0.469	172	2.22	60	0.135	61	0.385	-52
		2.5	0.502	160	1.82	50	0.166	63	0.364	-62
		3.0	0.512	151	1.57	41	0.203	64	0.372	-72
		3.5	0.514	140	1.38	33	0.244	63	0.381	-81
		4.0	0.548	132	1.24	25	0.289	61	0.391	-92
		4.5	0.545	124	1.13	19	0.341	58	0.404	-102
		5.0	0.571	117	1.04	13	0.394	54	0.403	-114
	15.0	0.1	0.598	-56	28.57	144	0.020	68	0.814	-26
		0.3	0.458	-115	15.28	111	0.038	59	0.491	-43
		0.5	0.396	-141	9.78	98	0.050	62	0.367	-40
		0.7	0.387	-156	7.18	90	0.063	64	0.315	-39
		0.9	0.381	-166	5.67	84	0.077	66	0.290	-39
		1.0	0.377	-170	5.12	81	0.084	67	0.284	-40
		1.3	0.389	-179	4.01	74	0.106	68	0.264	-41
		1.5	0.394	174	3.51	70	0.120	68	0.257	-44
		2.0	0.397	164	2.71	60	0.157	66	0.247	-52
		2.5	0.436	154	2.21	51	0.194	65	0.224	-64
		3.0	0.443	148	1.91	43	0.233	62	0.233	-73
		3.5	0.448	138	1.68	35	0.272	59	0.240	-82
		4.0	0.479	131	1.52	28	0.311	56	0.250	-92
		4.5	0.474	125	1.39	21	0.353	53	0.265	-101
		5.0	0.506	118	1.29	15	0.395	49	0.263	-113
	30.0	0.1	0.476	-76	36.18	135	0.017	66	0.706	-33
		0.3	0.396	-134	16.55	104	0.032	65	0.387	-44
		0.5	0.364	-156	10.31	94	0.046	69	0.296	-38
		0.7	0.365	-167	7.50	87	0.061	71	0.261	-36
		0.9	0.364	-175	5.88	81	0.077	72	0.245	-36
		1.0	0.360	-178	5.23	79	0.085	72	0.242	-37
		1.3	0.376	175	4.16	73	0.108	71	0.228	-39
		1.5	0.382	170	3.63	69	0.124	71	0.222	-41
		2.0	0.387	161	2.79	59	0.163	68	0.215	-50
		2.5	0.428	152	2.28	51	0.200	65	0.193	-63
		3.0	0.436	146	1.96	43	0.240	62	0.202	-72
		3.5	0.440	136	1.73	35	0.279	59	0.210	-82
		4.0	0.473	130	1.56	28	0.317	55	0.219	-92
		4.5	0.470	124	1.43	21	0.359	52	0.234	-101
		5.0	0.499	118	1.32	15	0.400	48	0.233	-113

Table 1. Common Emitter S-Parameters (continued)

V _{CE} (Vdc)	I _C (mA)	f (GHz)	NF _{min} (dB)	Γ _o		R _N (Ω)	R _N	GNF (dB)
				MAG	∠φ			
1.0	1.0	0.3	0.97	0.58	38	18	0.35	15.6
		0.5	1.16	0.56	62	18	0.36	13.1
		0.7	1.35	0.54	83	17	0.34	10.9
		0.9	1.52	0.53	102	15	0.30	9.0
		1.0	1.61	0.53	111	14	0.28	8.2
		1.5	2.02	0.56	149	8	0.16	5.2
		2.0	2.39	0.64	175	4	0.08	4.5
3.0	3.0	0.3	0.93	0.37	37	10	0.20	19.8
		0.5	1.03	0.36	59	10	0.20	17.0
		0.7	1.13	0.36	80	10	0.20	14.6
		0.9	1.24	0.37	99	9	0.18	12.4
		1.0	1.29	0.37	108	9	0.18	11.4
		1.5	1.59	0.43	146	7	0.13	8.6
		2.0	1.92	0.53	172	4	0.08	6.8
6.0	5.0	0.3	0.98	0.29	34	10	0.19	21.4
		0.5	1.05	0.29	56	10	0.19	18.5
		0.7	1.12	0.29	76	9	0.19	16.0
		0.9	1.20	0.30	95	9	0.18	13.9
		1.0	1.28	0.31	104	9	0.17	13.0
		1.5	1.51	0.37	142	7	0.13	10.1
		2.0	1.84	0.47	170	5	0.10	8.2

Table 2. Common Emitter Noise Parameters

PACKAGE DIMENSIONS

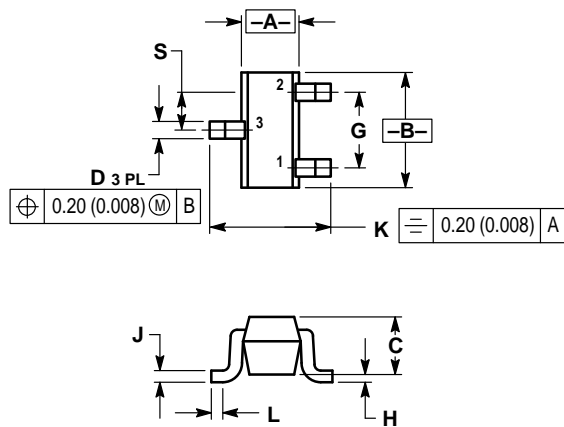

- NOTES:
1. DIMENSIONING AND TOLERANCING PER ANSI Y14.5M, 1982.
 2. CONTROLLING DIMENSION: MILLIMETER.

DIM	MILLIMETERS		INCHES	
	MIN	MAX	MIN	MAX
A	0.70	0.80	0.028	0.031
B	1.40	1.80	0.055	0.071
C	0.60	0.90	0.024	0.035
D	0.15	0.30	0.006	0.012
G	1.00 BSC		0.039 BSC	
H	—	0.10	—	0.004
J	0.10	0.25	0.004	0.010
K	1.45	1.75	0.057	0.069
L	0.10	0.20	0.004	0.008
S	0.50 BSC		0.020 BSC	

- STYLE 1:
 PIN 1. BASE
 2. EMITTER
 3. COLLECTOR

CASE 463-01
ISSUE A

Motorola reserves the right to make changes without further notice to any products herein. Motorola makes no warranty, representation or guarantee regarding the suitability of its products for any particular purpose, nor does Motorola assume any liability arising out of the application or use of any product or circuit, and specifically disclaims any and all liability, including without limitation consequential or incidental damages. "Typical" parameters which may be provided in Motorola data sheets and/or specifications can and do vary in different applications and actual performance may vary over time. All operating parameters, including "Typicals" must be validated for each customer application by customer's technical experts. Motorola does not convey any license under its patent rights nor the rights of others. Motorola products are not designed, intended, or authorized for use as components in systems intended for surgical implant into the body, or other applications intended to support or sustain life, or for any other application in which the failure of the Motorola product could create a situation where personal injury or death may occur. Should Buyer purchase or use Motorola products for any such unintended or unauthorized application, Buyer shall indemnify and hold Motorola and its officers, employees, subsidiaries, affiliates, and distributors harmless against all claims, costs, damages, and expenses, and reasonable attorney fees arising out of, directly or indirectly, any claim of personal injury or death associated with such unintended or unauthorized use, even if such claim alleges that Motorola was negligent regarding the design or manufacture of the part. Motorola and  are registered trademarks of Motorola, Inc. Motorola, Inc. is an Equal Opportunity/Affirmative Action Employer.

Mfax is a trademark of Motorola, Inc.

How to reach us:

USA/EUROPE/Locations Not Listed: Motorola Literature Distribution;
 P.O. Box 5405, Denver, Colorado 80217. 1-303-675-2140 or 1-800-441-2447

JAPAN: Nippon Motorola Ltd.: SPD, Strategic Planning Office, 4-32-1,
 Nishi-Gotanda, Shinagawa-ku, Tokyo 141, Japan. 81-3-5487-8488

Customer Focus Center: 1-800-521-6274

Mfax™: RMFAX0@email.sps.mot.com – TOUCHTONE 1-602-244-6609
 Motorola Fax Back System – US & Canada ONLY 1-800-774-1848
 – http://sps.motorola.com/mfax/

ASIA/PACIFIC: Motorola Semiconductors H.K. Ltd.; 8B Tai Ping Industrial Park,
 51 Ting Kok Road, Tai Po, N.T., Hong Kong. 852-26629298

HOME PAGE: <http://motorola.com/sps/>

