

**The RF Line**  
**NPN Silicon**  
**Low Noise Transistors**

**MRF949T1**

**I<sub>Cmax</sub> = 50 mA**  
**LOW NOISE**  
**TRANSISTORS**

Motorola's MRF949 is a high performance NPN transistor designed for use in high gain, low noise small-signal amplifiers. The MRF949 is well suited for low voltage wireless applications. This device features a 9 GHz DC current gain-bandwidth product with excellent linearity.

- Low Noise Figure,  $NF_{min} = 1.4 \text{ dB (Typ) @ 1 GHz @ 5 mA}$
- High Current Gain-Bandwidth Product,  $f_t = 9 \text{ GHz @ 15 mA}$
- Maximum Stable Gain = 18 dB @ 1 GHz @ 5 mA
- Output Third Order Intercept,  $OIP_3 = +29 \text{ dBm @ 1 GHz @ 10 mA}$
- Fully Ion-Implanted with Gold Metallization and Nitride Passivation
- Available in Tape and Reel Packaging Options:  
T1 Suffix = 3,000 Units per Reel



**CASE 463-01, STYLE 1**  
**(SC-90)**

**MAXIMUM RATINGS**

Rating	Symbol	Value	Unit
Collector-Emitter Voltage	$V_{CEO}$	10	Vdc
Collector-Base Voltage	$V_{CBO}$	20	Vdc
Emitter-Base Voltage	$V_{EBO}$	1.5	Vdc
Power Dissipation (1) $T_C = 75^\circ\text{C}$ Derate linearly above $T_C = 75^\circ\text{C}$ @	$P_{Dmax}$	0.144 1.92	Watts mW/°C
Collector Current — Continuous (2)	$I_C$	50	mA
Maximum Junction Temperature	$T_{Jmax}$	150	°C
Storage Temperature	$T_{stg}$	-55 to +150	°C
Thermal Resistance, Junction to Case	$R_{\theta JC}$	520	°C/W

**DEVICE MARKINGS**

MRF949T1 = JL

- (1) To calculate the junction temperature use  $T_J = (P_D \times R_{\theta JC}) + T_C$ . The case temperature is measured on collector lead adjacent to the package body.
- (2)  $I_C$  — Continuous (MTBF > 10 years).

**ELECTRICAL CHARACTERISTICS** ( $T_A = 25^\circ\text{C}$  unless otherwise noted)

Characteristic	Symbol	Min	Typ	Max	Unit
<b>OFF CHARACTERISTICS (3)</b>					
Collector–Emitter Breakdown Voltage ( $I_C = 0.1\text{ mA}$ , $I_B = 0$ )	$V_{(BR)CEO}$	10	12	—	Vdc
Collector–Base Breakdown Voltage ( $I_C = 0.1\text{ mA}$ , $I_E = 0$ )	$V_{(BR)CBO}$	20	23	—	Vdc
Emitter Cutoff Current ( $V_{EB} = 1\text{ V}$ , $I_C = 0$ )	$I_{EBO}$	—	—	0.1	$\mu\text{A}$
Collector Cutoff Current ( $V_{CB} = 10\text{ V}$ , $I_E = 0$ )	$I_{CBO}$	—	—	0.1	$\mu\text{A}$

**ON CHARACTERISTICS (3)**

DC Current Gain ( $V_{CE} = 6\text{ V}$ , $I_C = 5\text{ mA}$ )	$h_{FE}$	50	—	—	—
---	----------	----	---	---	---

**DYNAMIC CHARACTERISTICS**

Collector–Base Capacitance ( $V_{CB} = 1\text{ V}$ , $I_E = 0$ , $f = 1\text{ MHz}$ ) ( $V_{CB} = 5\text{ V}$ , $I_E = 0$ , $f = 1\text{ MHz}$ )	$C_{cb}$	— —	0.4 0.3	— —	pF
Current Gain — Bandwidth Product ( $V_{CE} = 6\text{ V}$ , $I_C = 30\text{ mA}$ , $f = 1\text{ GHz}$ )	$f_T$	—	9	—	GHz

**PERFORMANCE CHARACTERISTICS**

Conditions	Symbol	Min	Typ	Max	Unit
Insertion Gain ( $V_{CE} = 1\text{ V}$ , $I_C = 1\text{ mA}$ , $f = 1\text{ GHz}$ ) ( $V_{CE} = 6\text{ V}$ , $I_C = 15\text{ mA}$ , $f = 1\text{ GHz}$ )	$ S_{21} ^2$	— —	7 15	— —	dB
Maximum Unilateral Gain (4) ( $V_{CE} = 1\text{ V}$ , $I_C = 1\text{ mA}$ , $f = 1\text{ GHz}$ ) ( $V_{CE} = 6\text{ V}$ , $I_C = 15\text{ mA}$ , $f = 1\text{ GHz}$ )	$G_{Umax}$	— —	13 17	— —	dB
Maximum Stable Gain and/or Maximum Available Gain (5) ( $V_{CE} = 1\text{ V}$ , $I_C = 1\text{ mA}$ , $f = 1\text{ GHz}$ ) ( $V_{CE} = 6\text{ V}$ , $I_C = 15\text{ mA}$ , $f = 1\text{ GHz}$ )	MSG MAG	— —	12 18	— —	dB
Noise Figure — Minimum ( $V_{CE} = 1\text{ V}$ , $I_C = 1\text{ mA}$ , $f = 1\text{ GHz}$ ) ( $V_{CE} = 6\text{ V}$ , $I_C = 5\text{ mA}$ , $f = 1\text{ GHz}$ )	$NF_{min}$	— —	1.6 1.4	— —	dB
Noise Resistance ( $V_{CE} = 1\text{ V}$ , $I_C = 1\text{ mA}$ , $f = 1\text{ GHz}$ ) ( $V_{CE} = 6\text{ V}$ , $I_C = 5\text{ mA}$ , $f = 1\text{ GHz}$ )	$R_N$	— —	24 19	— —	$\Omega$
Associated Gain at Minimum NF ( $V_{CE} = 1\text{ V}$ , $I_C = 1\text{ mA}$ , $f = 1\text{ GHz}$ ) ( $V_{CE} = 6\text{ V}$ , $I_C = 5\text{ mA}$ , $f = 1\text{ GHz}$ )	$G_{NF}$	— —	10 15	— —	dB
Output Power at 1 dB Gain Compression (6) ( $V_{CE} = 6\text{ V}$ , $I_C = 15\text{ mA}$ , $f = 1\text{ GHz}$ )	$P_{1dB}$	—	+13	—	dBm
Output Third Order Intercept (6) ( $V_{CE} = 6\text{ V}$ , $I_C = 15\text{ mA}$ , $f = 1\text{ GHz}$ )	$OIP_3$	—	+28	—	dBm

(3) Pulse width  $\leq 300\ \mu\text{s}$ , duty cycle  $\leq 2\%$  pulsed.

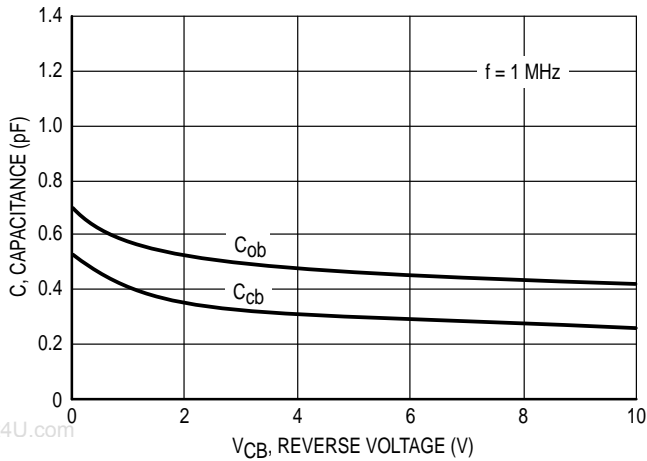
(4) Maximum unilateral gain is  $G_{Umax} = \frac{|S_{21}|^2}{(1-|S_{11}|^2)(1-|S_{22}|^2)}$

(5) Maximum available gain and maximum stable gain are defined by the K factor as follows:  $MAG = \frac{|S_{21}|}{|S_{12}|} (K \pm \sqrt{K^2 - 1})$ , if  $K > 1$

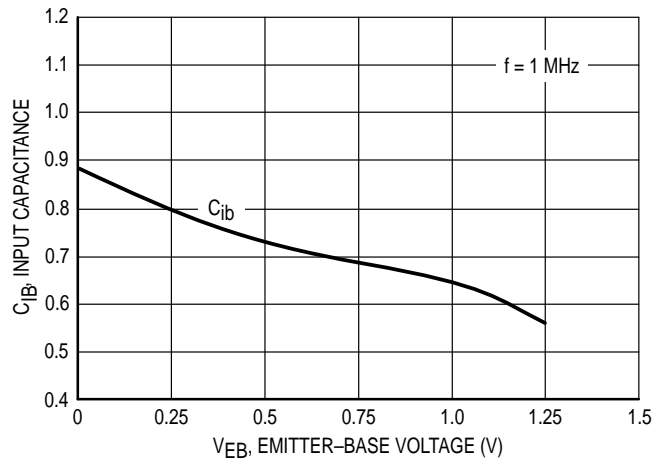
(6)  $Z_{in} = 50\ \Omega$  and  $Z_{out}$  matched for optimum  $IP_3$ .

$MSG = \frac{|S_{21}|}{|S_{12}|}$ , if  $K < 1$

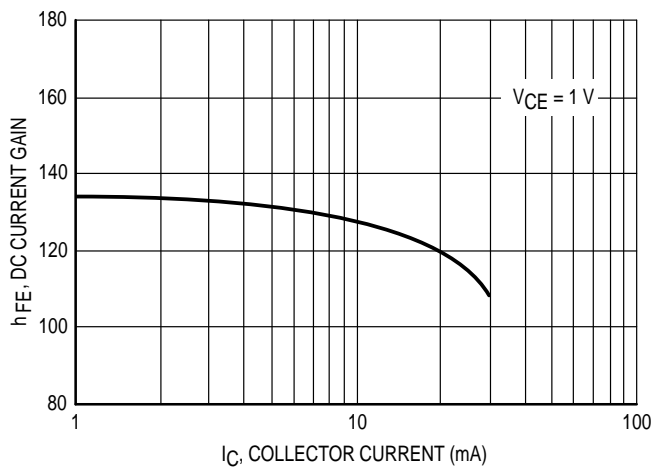
## TYPICAL CHARACTERISTICS



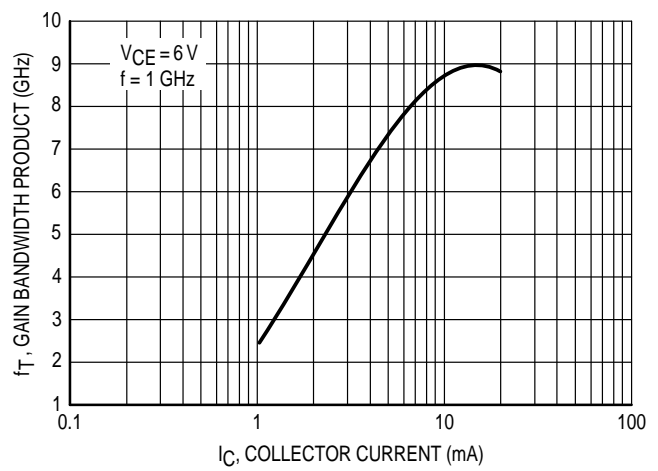
**Figure 1. Capacitance versus Voltage**



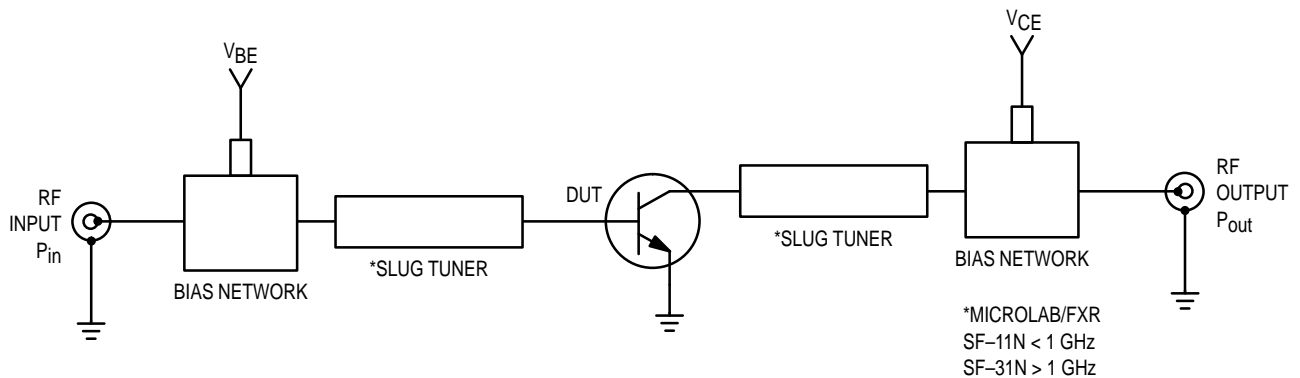
**Figure 2. Input Capacitance versus Voltage**



**Figure 3. DC Current Gain versus Collector Current**

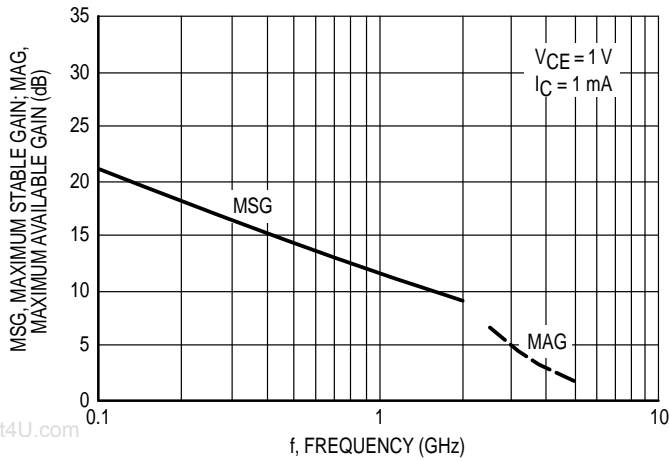


**Figure 4. Gain-Bandwidth Product versus Collector Current**

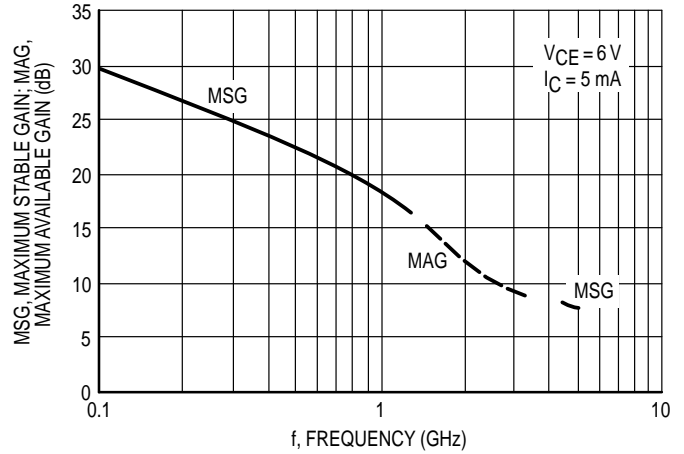


**Figure 5. Functional Circuit Schematic**

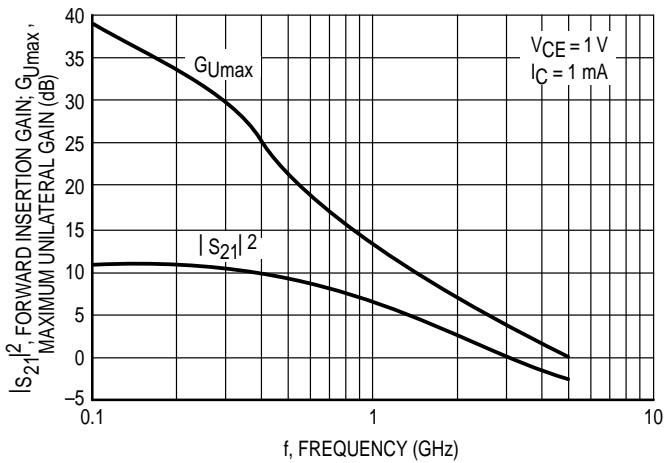
## TYPICAL CHARACTERISTICS



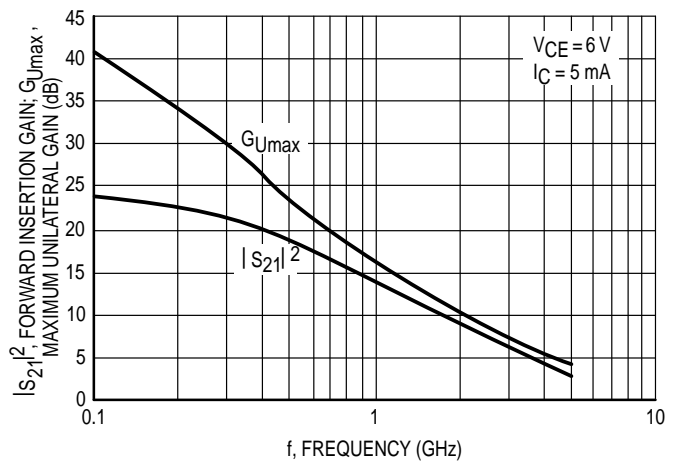
**Figure 6. Maximum Stable/Available Gain versus Frequency**



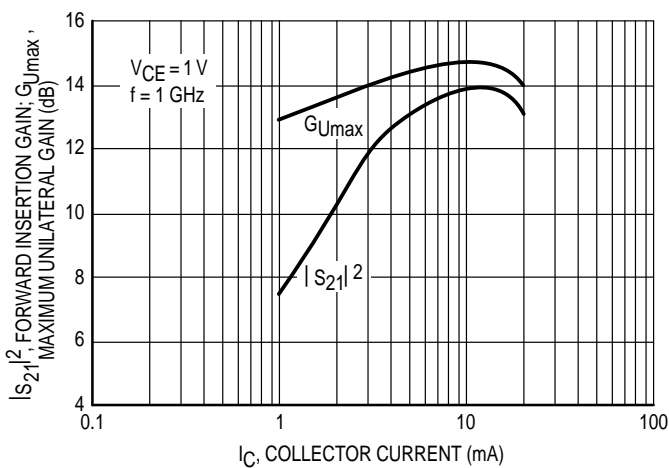
**Figure 7. Maximum Stable/Available Gain versus Frequency**



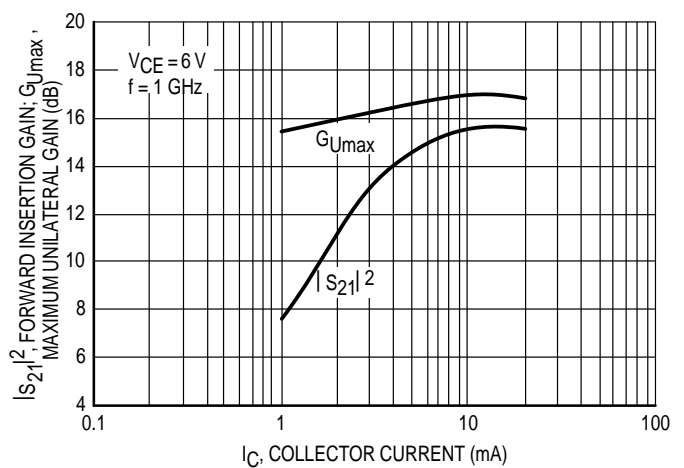
**Figure 8. Maximum Unilateral Gain and Forward Insertion Gain versus Frequency**



**Figure 9. Maximum Unilateral Gain and Forward Insertion Gain versus Frequency**

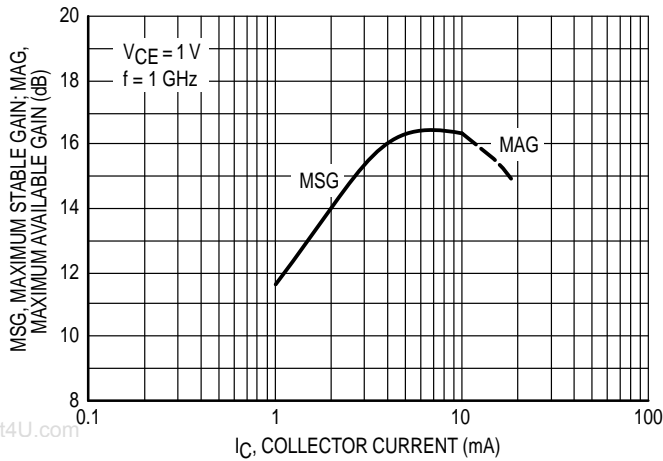


**Figure 10. Maximum Unilateral Gain and Forward Insertion Gain versus Collector Current**

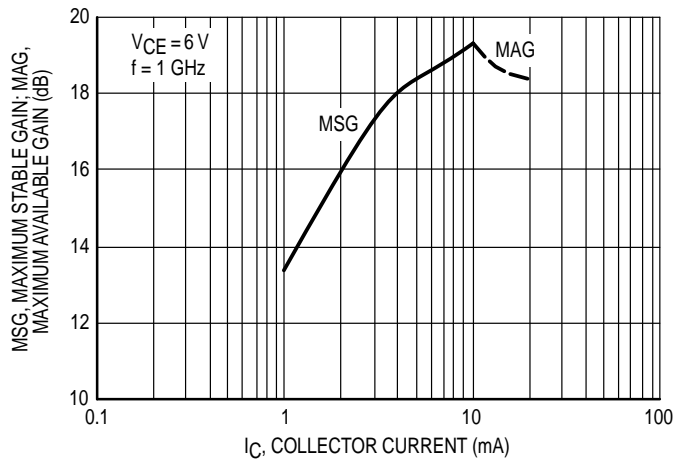


**Figure 11. Maximum Unilateral Gain and Forward Insertion Gain versus Collector Current**

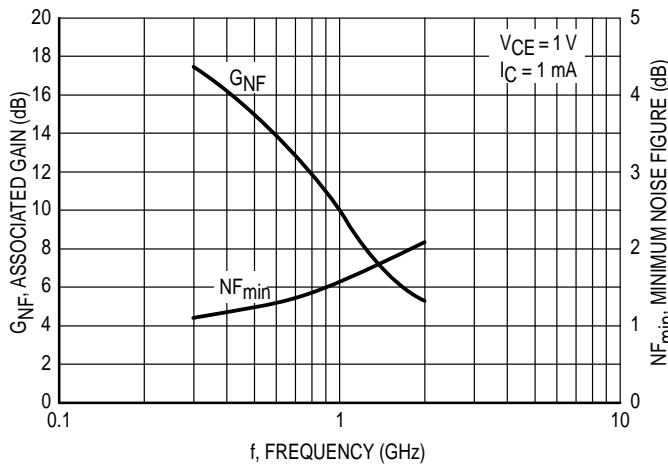
## TYPICAL CHARACTERISTICS



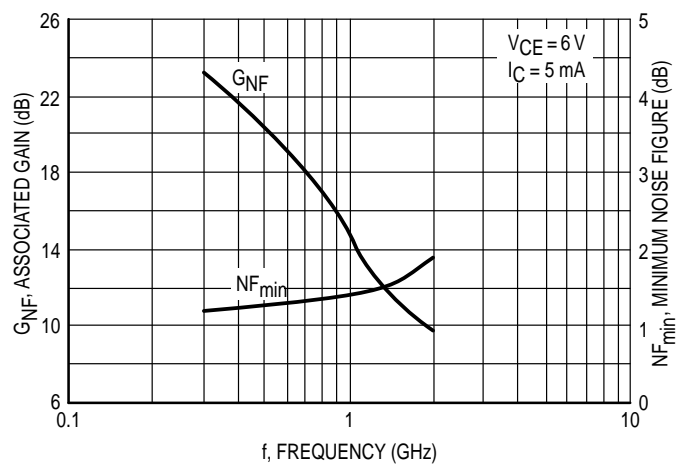
**Figure 12. Maximum Stable/Available Gain versus Collector Current**



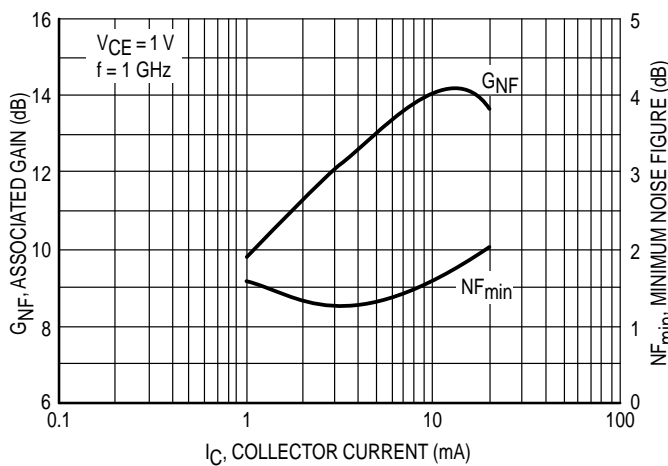
**Figure 13. Maximum Stable/Available Gain versus Collector Current**



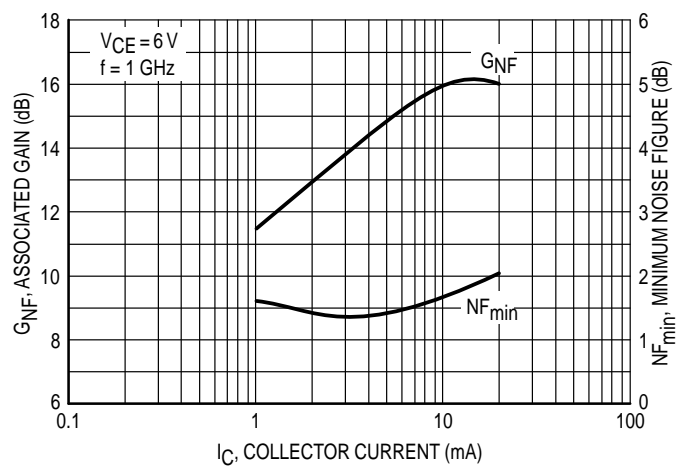
**Figure 14. Minimum Noise Figure and Associated Gain versus Frequency**



**Figure 15. Minimum Noise Figure and Associated Gain versus Frequency**

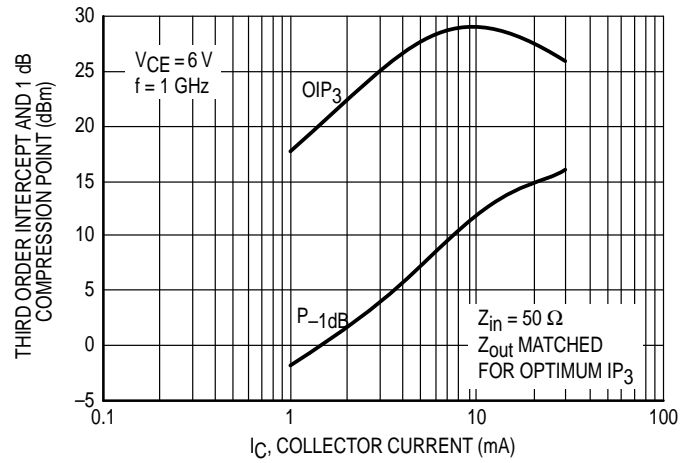


**Figure 16. Minimum Noise Figure and Associated Gain versus Collector Current**



**Figure 17. Minimum Noise Figure and Associated Gain versus Collector Current**

## TYPICAL CHARACTERISTICS



**Figure 18. Output Third Order Intercept and Output Power at 1 dB Gain Compression versus Collector Current**

$V_{CE} = 1\text{ V}$   
 $I_C = 1\text{ mA}$

f (GHz)	NF OPT	$\Gamma_O$	$R_N$	K
1.0	1.57 dB	$0.56 \angle 57.7^\circ$	24.2	0.48

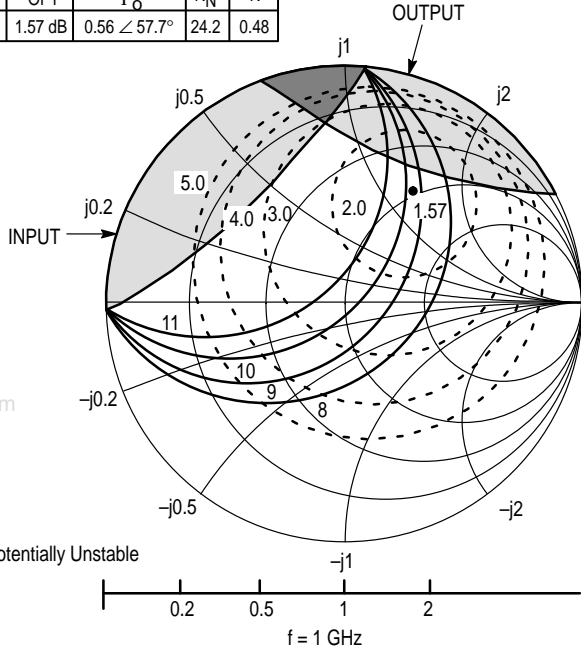


Figure 19. MRF949T1 Series Constant Gain and Noise Figure Contours

$V_{CE} = 1\text{ V}$   
 $I_C = 1\text{ mA}$

f (GHz)	NF OPT	$\Gamma_O$	$R_N$	K
2.0	2.08 dB	$0.50 \angle 119.8^\circ$	13	0.93

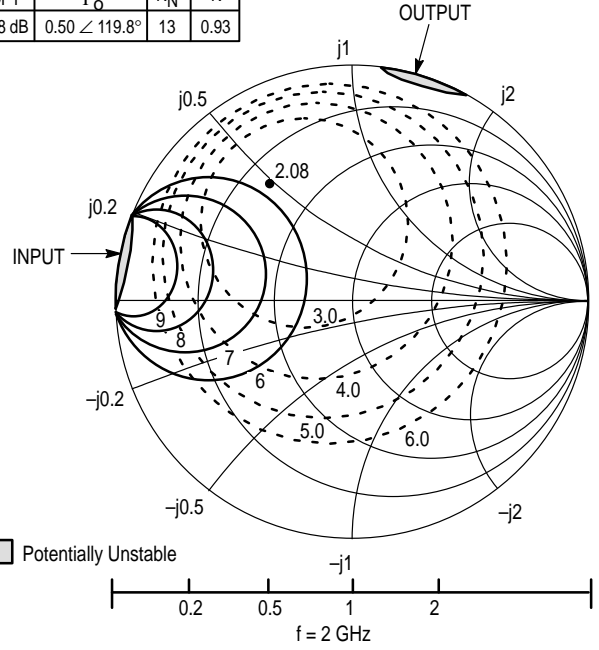


Figure 20. MRF949T1 Series Constant Gain and Noise Figure Contours

$V_{CE} = 3\text{ V}$   
 $I_C = 3\text{ mA}$

f (GHz)	NF OPT	$\Gamma_O$	$R_N$	K
1.0	1.34 dB	$0.45 \angle 47.3^\circ$	18.2	0.73

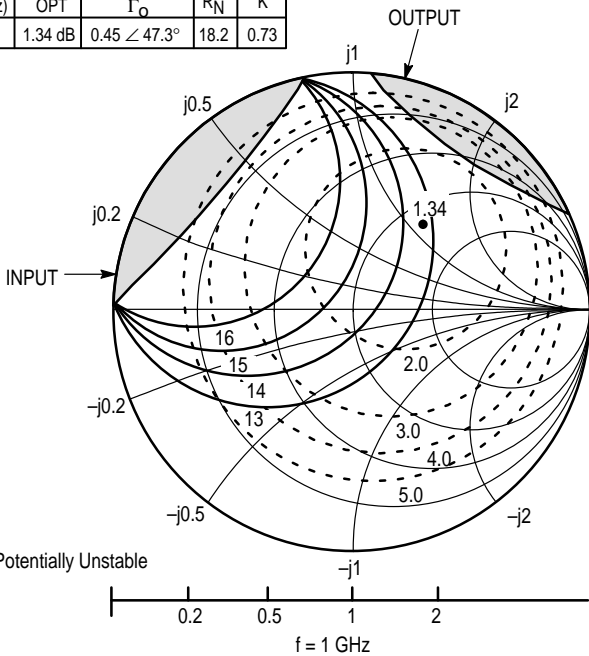


Figure 21. MRF949T1 Series Constant Gain and Noise Figure Contours

$V_{CE} = 6\text{ V}$   
 $I_C = 5\text{ mA}$

f (GHz)	NF OPT	$\Gamma_O$	$R_N$	K
1.0	1.41 dB	$0.44 \angle 42.9^\circ$	19	0.86

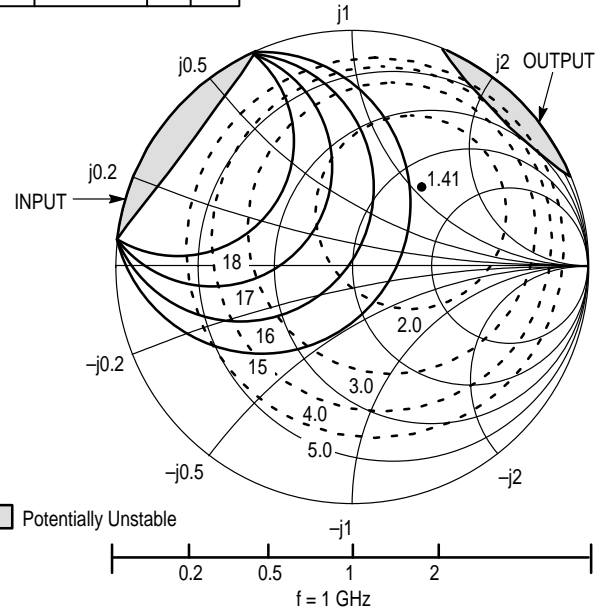


Figure 22. MRF949T1 Series Constant Gain and Noise Figure Contours

VCE (Vdc)	IC (mA)	f (GHz)	S11		S21		S12		S22		
			S11	∠φ	S21	∠φ	S12	∠φ	S22	∠φ	
1.0	1.0	0.1	0.964	-12	3.62	171	0.028	82	0.989	-6	
		0.3	0.926	-36	3.41	152	0.078	69	0.950	-17	
		0.5	0.872	-55	2.98	135	0.115	56	0.878	-24	
		0.7	0.773	-73	2.67	121	0.140	47	0.811	-31	
		0.9	0.701	-89	2.40	110	0.157	40	0.751	-37	
		1.0	0.672	-96	2.27	105	0.163	37	0.725	-39	
		1.3	0.605	-116	1.95	90	0.172	31	0.660	-44	
		1.5	0.579	-127	1.77	83	0.176	27	0.631	-48	
		2.0	0.537	-152	1.43	66	0.173	24	0.584	-56	
		2.5	0.521	-173	1.22	52	0.168	25	0.555	-65	
	3.0	0.520	171	1.06	41	0.168	31	0.542	-74		
	3.5	0.529	157	0.94	31	0.179	38	0.543	-84		
	4.0	0.543	145	0.84	24	0.205	45	0.541	-95		
	4.5	0.552	133	0.79	17	0.248	48	0.525	-106		
	5.0	0.571	123	0.72	13	0.296	48	0.527	-117		
	3.0	3.0	0.1	0.896	-20	9.79	165	0.027	79	0.960	-12
			0.3	0.780	-57	8.17	138	0.068	61	0.826	-29
			0.5	0.653	-80	6.36	120	0.089	51	0.680	-38
			0.7	0.551	-101	5.11	107	0.103	46	0.578	-43
			0.9	0.488	-117	4.23	97	0.113	43	0.510	-47
1.0			0.468	-125	3.89	93	0.117	43	0.484	-48	
1.3			0.431	-143	3.14	82	0.128	43	0.425	-51	
1.5			0.420	-153	2.78	77	0.137	43	0.401	-54	
2.0			0.410	-174	2.16	63	0.157	44	0.364	-60	
2.5			0.415	169	1.80	52	0.179	45	0.343	-68	
3.0		0.426	157	1.55	43	0.205	46	0.332	-76		
3.5		0.439	146	1.37	34	0.234	46	0.332	-85		
4.0		0.454	137	1.24	26	0.265	45	0.329	-95		
4.5		0.470	128	1.13	19	0.302	44	0.323	-105		
5.0		0.492	119	1.05	12	0.339	41	0.324	-116		
5.0		5.0	0.1	0.831	-27	14.66	160	0.026	75	0.929	-16
			0.3	0.668	-72	10.92	129	0.059	57	0.719	-37
			0.5	0.530	-97	7.88	112	0.075	51	0.556	-44
			0.7	0.450	-118	6.06	100	0.087	49	0.458	-48
			0.9	0.409	-133	4.89	92	0.098	49	0.400	-50
	1.0		0.397	-140	4.47	88	0.103	50	0.379	-51	
	1.3		0.378	-157	3.55	79	0.119	51	0.331	-53	
	1.5		0.376	-166	3.12	74	0.131	51	0.312	-56	
	2.0		0.378	177	2.41	62	0.159	52	0.283	-62	
	2.5		0.392	162	1.99	52	0.190	51	0.266	-70	
3.0	0.402	151	1.71	43	0.221	50	0.258	-78			
3.5	0.417	141	1.51	35	0.253	48	0.257	-87			
4.0	0.433	133	1.36	27	0.286	46	0.254	-97			
4.5	0.451	125	1.25	20	0.321	43	0.250	-107			
5.0	0.469	117	1.16	13	0.356	40	0.251	-118			

Table 1. Common Emitter S-Parameters



VCE (Vdc)	IC (mA)	f (GHz)	S11		S21		S12		S22			
			S11	∠φ	S21	∠φ	S12	∠φ	S22	∠φ		
3.0	3.0	0.1	0.909	-17	9.75	166	0.019	80	0.972	-9		
		0.3	0.805	-48	8.43	142	0.051	65	0.874	-22		
		0.5	0.680	-70	6.76	124	0.070	55	0.756	-29		
		0.7	0.567	-89	5.55	111	0.082	51	0.669	-33		
		0.9	0.490	-104	4.65	102	0.091	48	0.608	-36		
		1.0	0.464	-111	4.30	98	0.095	48	0.587	-37		
		1.3	0.408	-130	3.49	86	0.105	48	0.534	-39		
		1.5	0.391	-141	3.10	81	0.113	48	0.513	-41		
		2.0	0.366	-163	2.42	68	0.131	50	0.479	-46		
		2.5	0.365	178	2.01	56	0.151	52	0.459	-52		
		3.0	0.371	164	1.73	47	0.175	53	0.448	-59		
		3.5	0.385	152	1.52	38	0.202	54	0.446	-67		
		4.0	0.404	142	1.37	30	0.232	54	0.443	-75		
		4.5	0.420	132	1.26	23	0.268	53	0.436	-83		
		5.0	0.443	124	1.16	16	0.307	51	0.434	-92		
		5.0	5.0	0.1	0.853	-22	14.73	162	0.019	78	0.950	-12
				0.3	0.697	-60	11.59	134	0.045	62	0.791	-27
				0.5	0.547	-82	8.62	116	0.060	56	0.652	-32
				0.7	0.447	-102	6.75	104	0.070	54	0.565	-35
0.9	0.386			-117	5.50	96	0.080	54	0.513	-37		
1.0	0.368			-124	5.03	92	0.085	54	0.494	-37		
1.3	0.332			-142	4.02	83	0.099	55	0.453	-39		
1.5	0.323			-152	3.54	78	0.109	56	0.436	-40		
2.0	0.315			-173	2.74	66	0.134	57	0.408	-45		
2.5	0.323			170	2.26	56	0.161	57	0.392	-51		
3.0	0.334			158	1.93	47	0.189	56	0.384	-58		
3.5	0.348			147	1.70	38	0.218	55	0.380	-65		
4.0	0.369			138	1.53	31	0.249	53	0.376	-73		
4.5	0.387			130	1.40	24	0.283	51	0.371	-81		
5.0	0.410			122	1.30	17	0.319	49	0.367	-89		
10.0	10.0			0.1	0.730	-33	23.83	154	0.017	74	0.896	-17
				0.3	0.518	-80	15.52	122	0.037	61	0.647	-33
				0.5	0.382	-103	10.52	106	0.049	60	0.517	-34
				0.7	0.319	-122	7.89	96	0.060	61	0.450	-35
		0.9	0.287	-137	6.28	89	0.072	62	0.414	-35		
		1.0	0.279	-144	5.71	86	0.078	63	0.402	-35		
		1.3	0.268	-159	4.49	79	0.096	64	0.374	-36		
		1.5	0.269	-168	3.94	74	0.108	64	0.362	-38		
		2.0	0.278	176	3.02	64	0.139	63	0.343	-42		
		2.5	0.294	161	2.48	55	0.171	61	0.331	-49		
		3.0	0.311	151	2.12	47	0.202	59	0.323	-56		
		3.5	0.329	142	1.86	39	0.233	56	0.319	-63		
		4.0	0.347	134	1.68	31	0.265	53	0.314	-71		
		4.5	0.367	127	1.53	24	0.298	51	0.309	-79		
		5.0	0.390	120	1.42	18	0.332	47	0.305	-87		

Table 1. Common Emitter S-Parameters (continued)

VCE (Vdc)	IC (mA)	f (GHz)	S11		S21		S12		S22		
			S11	∠φ	S21	∠φ	S12	∠φ	S22	∠φ	
6.0	5.0	0.1	0.870	-20	14.57	163	0.016	79	0.958	-10	
		0.3	0.719	-55	11.68	136	0.040	64	0.822	-23	
		0.5	0.566	-76	8.81	118	0.053	58	0.697	-28	
		0.7	0.457	-94	6.96	106	0.063	56	0.619	-30	
		0.9	0.387	-109	5.69	98	0.072	56	0.571	-31	
		1.0	0.365	-115	5.22	94	0.076	56	0.554	-32	
		1.3	0.320	-133	4.18	84	0.089	57	0.516	-33	
		1.5	0.306	-143	3.69	79	0.098	58	0.501	-35	
		2.0	0.291	-164	2.86	67	0.121	59	0.476	-39	
		2.5	0.293	178	2.35	57	0.146	60	0.462	-45	
	3.0	0.304	165	2.02	48	0.171	59	0.454	-51		
	3.5	0.319	154	1.78	40	0.198	59	0.452	-58		
	4.0	0.339	145	1.60	32	0.228	58	0.449	-65		
	4.5	0.359	136	1.46	25	0.261	56	0.445	-72		
	5.0	0.384	128	1.35	18	0.297	54	0.442	-80		
	15.0	15.0	0.1	0.698	-37	28.78	150	0.014	74	0.877	-17
			0.3	0.465	-84	17.38	118	0.030	63	0.627	-29
			0.5	0.331	-105	11.47	103	0.041	64	0.525	-28
			0.7	0.274	-123	8.50	95	0.052	66	0.478	-27
			0.9	0.248	-137	6.74	88	0.063	67	0.453	-27
			1.0	0.241	-143	6.12	85	0.069	67	0.443	-27
			1.3	0.232	-158	4.80	78	0.086	68	0.425	-28
			1.5	0.235	-165	4.20	74	0.098	68	0.415	-30
			2.0	0.247	179	3.22	64	0.127	66	0.400	-34
			2.5	0.264	165	2.64	55	0.156	64	0.390	-41
			3.0	0.279	156	2.25	48	0.185	62	0.385	-47
			3.5	0.297	148	1.98	40	0.214	60	0.381	-54
			4.0	0.317	141	1.78	33	0.245	57	0.376	-61
			4.5	0.338	134	1.62	26	0.276	55	0.371	-69
	5.0	0.361	127	1.50	19	0.310	52	0.366	-76		
30.0	30.0	0.1	0.550	-54	35.24	141	0.012	70	0.801	-20	
		0.3	0.351	-107	17.63	109	0.024	66	0.562	-25	
		0.5	0.267	-130	11.12	97	0.035	70	0.506	-21	
		0.7	0.246	-147	8.12	90	0.047	72	0.481	-21	
		0.9	0.239	-158	6.39	84	0.058	72	0.467	-22	
		1.0	0.239	-163	5.79	82	0.064	73	0.462	-22	
		1.3	0.245	-174	4.52	75	0.082	72	0.450	-24	
		1.5	0.253	-180	3.96	71	0.094	72	0.444	-26	
		2.0	0.272	168	3.04	62	0.123	70	0.433	-32	
		2.5	0.296	156	2.48	53	0.152	68	0.425	-39	
		3.0	0.315	148	2.12	45	0.182	66	0.421	-46	
		3.5	0.339	140	1.86	38	0.213	64	0.417	-54	
		4.0	0.358	134	1.67	31	0.245	62	0.414	-61	
		4.5	0.381	127	1.52	24	0.279	59	0.410	-69	
		5.0	0.406	120	1.40	18	0.317	56	0.406	-77	

Table 1. Common Emitter S-Parameters (continued)

V <sub>CE</sub> (V <sub>dc</sub> )	I <sub>C</sub> (mA)	f (GHz)	NF <sub>min</sub> (dB)	Γ <sub>o</sub>		R <sub>N</sub> (Ω)	R <sub>N</sub>	G <sub>NF</sub> (dB)
				MAG	∠φ			
1.0	1.0	0.3	1.14	0.67	16	29	0.58	17.3
		0.5	1.24	0.63	28	28	0.56	14.8
		0.7	1.35	0.60	40	27	0.53	12.5
		0.9	1.50	0.57	52	25	0.51	10.6
		1.0	1.57	0.56	58	24	0.49	9.7
		1.5	1.86	0.51	89	19	0.39	6.5
		2.0	2.08	0.50	120	13	0.26	5.2
3.0	3.0	0.3	1.04	0.57	12	21	0.42	21.5
		0.5	1.12	0.53	21	20	0.41	18.8
		0.7	1.21	0.50	31	19	0.39	16.4
		0.9	1.30	0.47	42	19	0.38	14.3
		1.0	1.34	0.45	47	18	0.37	13.4
		1.5	1.57	0.41	77	15	0.31	9.9
		2.0	1.80	0.40	110	12	0.24	8.4
6.0	5.0	0.3	1.22	0.54	11	22	0.44	23.1
		0.5	1.27	0.51	19	21	0.42	20.3
		0.7	1.32	0.48	28	20	0.41	17.8
		0.9	1.38	0.45	38	20	0.39	15.7
		1.0	1.41	0.44	43	19	0.38	14.7
		1.5	1.61	0.40	71	17	0.33	11.2
		2.0	1.86	0.38	103	13	0.26	9.5

Table 2. Common Emitter Noise Parameters

Name	Value	Name	Value	Name	Value
IS	4.598E-16	IRB	8.00E-05	TF	1.00E-11
BF	175	RBM	3	XTF	50
NF	0.9904	RE	0.45	VTF	1.2
VAF	22	RC	6	ITF	0.32
IKF	0.08	XTB	0	PTF	32
ISE	1.548E-14	EG	1.11	TR	1.00E-09
NE	1.703	XTI	3	FC	0.9
BR	76.1	CJE	8.70E-13		
NR	0.9952	VJE	0.905		
VAR	2.1	MJE	0.389		
IKR	0.02059	CJC	3.60E-13		
ISC	3.395E-16	VJC	0.4907		
NC	1.13	MJC	0.2198		
RB	8	XCJC	0.43		

Table 3. Spice Parameters (MRF949 Die Gummel-Poon Parameters)

www.DataSheet4U.com

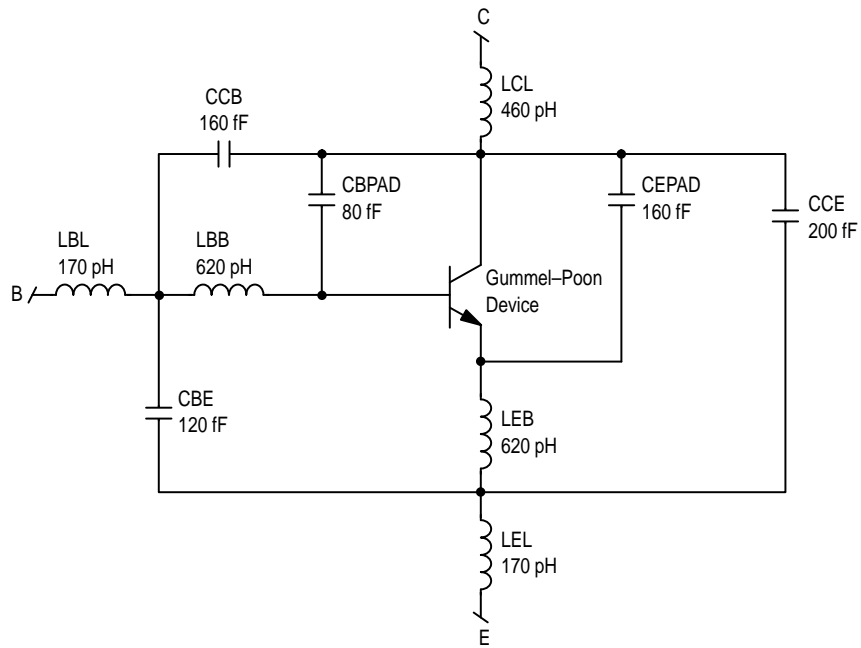
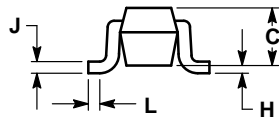
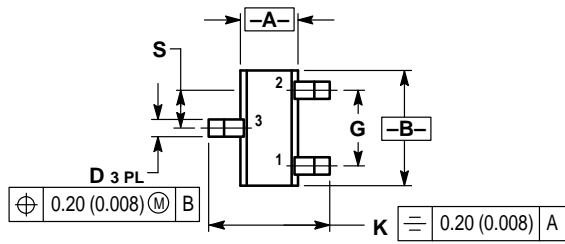


Figure 23. MRF949 SC-90 Package Equivalent Circuit

# PACKAGE DIMENSIONS




- NOTES:  
 1. DIMENSIONING AND TOLERANCING PER ANSI Y14.5M, 1982.  
 2. CONTROLLING DIMENSION: MILLIMETER.

DIM	MILLIMETERS		INCHES	
	MIN	MAX	MIN	MAX
A	0.70	0.80	0.028	0.031
B	1.40	1.80	0.055	0.071
C	0.60	0.90	0.024	0.035
D	0.15	0.30	0.006	0.012
G	1.00 BSC		0.039 BSC	
H	—	0.10	—	0.004
J	0.10	0.25	0.004	0.010
K	1.45	1.75	0.057	0.069
L	0.10	0.20	0.004	0.008
S	0.50 BSC		0.020 BSC	

- STYLE 1:  
 PIN 1. BASE  
 2. EMITTER  
 3. COLLECTOR

**CASE 463-01  
 ISSUE A**

Motorola reserves the right to make changes without further notice to any products herein. Motorola makes no warranty, representation or guarantee regarding the suitability of its products for any particular purpose, nor does Motorola assume any liability arising out of the application or use of any product or circuit, and specifically disclaims any and all liability, including without limitation consequential or incidental damages. "Typical" parameters which may be provided in Motorola data sheets and/or specifications can and do vary in different applications and actual performance may vary over time. All operating parameters, including "Typicals" must be validated for each customer application by customer's technical experts. Motorola does not convey any license under its patent rights nor the rights of others. Motorola products are not designed, intended, or authorized for use as components in systems intended for surgical implant into the body, or other applications intended to support or sustain life, or for any other application in which the failure of the Motorola product could create a situation where personal injury or death may occur. Should Buyer purchase or use Motorola products for any such unintended or unauthorized application, Buyer shall indemnify and hold Motorola and its officers, employees, subsidiaries, affiliates, and distributors harmless against all claims, costs, damages, and expenses, and reasonable attorney fees arising out of, directly or indirectly, any claim of personal injury or death associated with such unintended or unauthorized use, even if such claim alleges that Motorola was negligent regarding the design or manufacture of the part. Motorola and  are registered trademarks of Motorola, Inc. Motorola, Inc. is an Equal Opportunity/Affirmative Action Employer.

Mfax is a trademark of Motorola, Inc.

**How to reach us:**

**USA/EUROPE/Locations Not Listed:** Motorola Literature Distribution;  
P.O. Box 5405, Denver, Colorado 80217. 1-303-675-2140 or 1-800-441-2447

**JAPAN:** Nippon Motorola Ltd.: SPD, Strategic Planning Office, 141,  
4-32-1 Nishi-Gotanda, Shagawa-ku, Tokyo, Japan. 03-5487-8488

**Customer Focus Center: 1-800-521-6274**

**Mfax™:** RMFAX0@email.sps.mot.com – TOUCHTONE 1-602-244-6609  
Motorola Fax Back System – US & Canada ONLY 1-800-774-1848  
– http://sps.motorola.com/mfax/

**ASIA/PACIFIC:** Motorola Semiconductors H.K. Ltd.; 8B Tai Ping Industrial Park,  
51 Ting Kok Road, Tai Po, N.T., Hong Kong. 852-26629298

**HOME PAGE:** <http://motorola.com/sps/>



**MOTOROLA**

