

## The RF MOSFET Line

# RF Power Field Effect Transistors

## N-Channel Enhancement-Mode Lateral MOSFETs

**MRF5S21090LR3**  
**MRF5S21090LSR3**

Designed for W-CDMA base station applications with frequencies from 2110 to 2170 MHz. Suitable for TDMA, CDMA and multicarrier amplifier applications. To be used in Class AB for PCN - PCS/cellular radio and WLL applications.

- Typical 2-carrier W-CDMA Performance for  $V_{DD} = 28$  Volts,  $I_{DQ} = 850$  mA,  $f_1 = 2135$  MHz,  $f_2 = 2145$  MHz, Channel Bandwidth = 3.84 MHz, Adjacent Channels Measured over 3.84 MHz BW @  $f_1 - 5$  MHz and  $f_2 + 5$  MHz, Distortion Products Measured over a 3.84 MHz BW @  $f_1 - 10$  MHz and  $f_2 + 10$  MHz, Peak/Avg. = 8.5 dB @ 0.01% Probability on CCDF.

Output Power — 19 Watts Avg.

Power Gain — 14.5 dB

Efficiency — 26%

IM3 — -37.5 dBc

ACPR — -40.5 dBc

- Internally Matched, Controlled Q, for Ease of Use
- High Gain, High Efficiency and High Linearity
- Integrated ESD Protection
- Designed for Maximum Gain and Insertion Phase Flatness
- Capable of Handling 10:1 VSWR, @ 28 Vdc, 2140 MHz, 90 Watts CW Output Power
- Excellent Thermal Stability
- Characterized with Series Equivalent Large-Signal Impedance Parameters
- Qualified Up to a Maximum of 32  $V_{DD}$  Operation
- Available with Low Gold Plating Thickness on Leads. L Suffix Indicates 40 $\mu$ " Nominal.
- In Tape and Reel. R3 Suffix = 250 Units per 56 mm, 13 inch Reel.

2170 MHz, 19 W AVG.,  
 2 x W-CDMA, 28 V  
**LATERAL N-CHANNEL**  
**RF POWER MOSFETs**

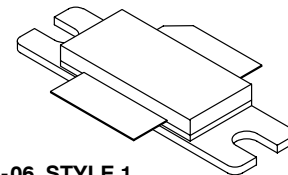

CASE 465-06, STYLE 1  
 NI-780  
 MRF5S21090LR3

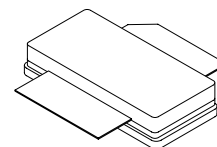

CASE 465A-06, STYLE 1  
 NI-780S  
 MRF5S21090LSR3

### MAXIMUM RATINGS

Rating	Symbol	Value	Unit
Drain-Source Voltage	$V_{DSS}$	65	Vdc
Gate-Source Voltage	$V_{GS}$	-0.5, +15	Vdc
Total Device Dissipation @ $T_C = 25^\circ\text{C}$ Derate above 25 $^\circ\text{C}$	$P_D$	224 1.28	Watts W/ $^\circ\text{C}$
Storage Temperature Range	$T_{stg}$	- 65 to +150	$^\circ\text{C}$
Operating Junction Temperature	$T_J$	200	$^\circ\text{C}$

### THERMAL CHARACTERISTICS

Characteristic	Symbol	Value (1,2)	Unit
Thermal Resistance, Junction to Case Case Temperature 80 $^\circ\text{C}$ , 90 W CW Case Temperature 80 $^\circ\text{C}$ , 19 W CW	$R_{\theta JC}$	0.78 0.80	$^\circ\text{C}/\text{W}$

(1) MTTF calculator available at <http://www.motorola.com/semiconductors/rf>. Select Tools/Software/Application Software/Calculators to access the MTTF calculators by product.

(2) Refer to AN1955/D, *Thermal Measurement Methodology of RF Power Amplifiers*. Go to <http://www.motorola.com/semiconductors/rf>. Select Documentation/Application Notes - AN1955.

NOTE - **CAUTION** - MOS devices are susceptible to damage from electrostatic charge. Reasonable precautions in handling and packaging MOS devices should be observed.

# Freescale Semiconductor, Inc.

## ESD PROTECTION CHARACTERISTICS

Test Conditions	Class
Human Body Model	1 (Minimum)
Machine Model	M3 (Minimum)
Charge Device Model	C7 (Minimum)

## ELECTRICAL CHARACTERISTICS (T<sub>C</sub> = 25°C unless otherwise noted)

Characteristic	Symbol	Min	Typ	Max	Unit
----------------	--------	-----	-----	-----	------

### OFF CHARACTERISTICS

Zero Gate Voltage Drain Leakage Current (V <sub>DS</sub> = 65 Vdc, V <sub>GS</sub> = 0 Vdc)	I <sub>DSS</sub>	—	—	10	μA <sub>dc</sub>
Zero Gate Voltage Drain Leakage Current (V <sub>DS</sub> = 28 Vdc, V <sub>GS</sub> = 0 Vdc)	I <sub>DSS</sub>	—	—	1	μA <sub>dc</sub>
Gate-Source Leakage Current (V <sub>GS</sub> = 5 Vdc, V <sub>DS</sub> = 0 Vdc)	I <sub>GSS</sub>	—	—	1	μA <sub>dc</sub>

### ON CHARACTERISTICS (DC)

Gate Threshold Voltage (V <sub>DS</sub> = 10 Vdc, I <sub>D</sub> = 200 μA <sub>dc</sub> )	V <sub>GS(th)</sub>	2.5	2.9	3.5	Vdc
Gate Quiescent Voltage (V <sub>DS</sub> = 28 Vdc, I <sub>D</sub> = 850 mA <sub>dc</sub> )	V <sub>GS(Q)</sub>	—	3.9	—	Vdc
Drain-Source On-Voltage (V <sub>GS</sub> = 10 Vdc, I <sub>D</sub> = 2 A <sub>dc</sub> )	V <sub>DS(on)</sub>	—	0.25	—	Vdc
Forward Transconductance (V <sub>DS</sub> = 10 Vdc, I <sub>D</sub> = 2 A <sub>dc</sub> )	g <sub>fs</sub>	—	5	—	S

### DYNAMIC CHARACTERISTICS (1)

Reverse Transfer Capacitance (V <sub>DS</sub> = 28 Vdc ± 30 mV(rms) <sub>ac</sub> @ 1 MHz, V <sub>GS</sub> = 0 Vdc)	C <sub>r<sub>ss</sub></sub>	—	1.7	—	pF
--	-----------------------------	---	-----	---	----

### FUNCTIONAL TESTS (In Motorola Test Fixture, 50 ohm system) 2-carrier W-CDMA, 3.84 MHz Channel Bandwidth Carriers, ACPR and IM3 measured in 3.84 MHz Bandwidth. Peak/Avg. = 8.5 dB @ 0.01% Probability on CCDF.

Common-Source Amplifier Power Gain (V <sub>DD</sub> = 28 Vdc, P <sub>out</sub> = 19 W Avg., I <sub>DQ</sub> = 850 mA, f <sub>1</sub> = 2112.5 MHz, f <sub>2</sub> = 2122.5 MHz and f <sub>1</sub> = 2157.5 MHz, f <sub>2</sub> = 2167.5 MHz)	G <sub>ps</sub>	12.5	14.5	—	dB
Drain Efficiency (V <sub>DD</sub> = 28 Vdc, P <sub>out</sub> = 19 W Avg., I <sub>DQ</sub> = 850 mA, f <sub>1</sub> = 2112.5 MHz, f <sub>2</sub> = 2122.5 MHz and f <sub>1</sub> = 2157.5 MHz, f <sub>2</sub> = 2167.5 MHz)	η	24	26	—	%
3rd Order Intermodulation Distortion (V <sub>DD</sub> = 28 Vdc, P <sub>out</sub> = 19 W Avg., I <sub>DQ</sub> = 850 mA, f <sub>1</sub> = 2112.5 MHz, f <sub>2</sub> = 2122.5 MHz and f <sub>1</sub> = 2157.5 MHz, f <sub>2</sub> = 2167.5 MHz; IM3 measured over 3.84 MHz BW at f <sub>1</sub> - 10 MHz and f <sub>2</sub> + 10 MHz referenced to carrier channel power.)	IM3	—	-37.5	-35	dBc
Adjacent Channel Power Ratio (V <sub>DD</sub> = 28 Vdc, P <sub>out</sub> = 19 W Avg., I <sub>DQ</sub> = 850 mA, f <sub>1</sub> = 2112.5 MHz, f <sub>2</sub> = 2122.5 MHz and f <sub>1</sub> = 2157.5 MHz, f <sub>2</sub> = 2167.5 MHz; ACPR measured over 3.84 MHz at f <sub>1</sub> - 5 MHz and f <sub>2</sub> + 5 MHz.)	ACPR	—	-40.5	-38	dBc
Input Return Loss (V <sub>DD</sub> = 28 Vdc, P <sub>out</sub> = 19 W Avg., I <sub>DQ</sub> = 850 mA, f <sub>1</sub> = 2112.5 MHz, f <sub>2</sub> = 2122.5 MHz and f <sub>1</sub> = 2157.5 MHz, f <sub>2</sub> = 2167.5 MHz)	IRL	—	-15	-9	dB

(1) Part is internally matched both on input and output.

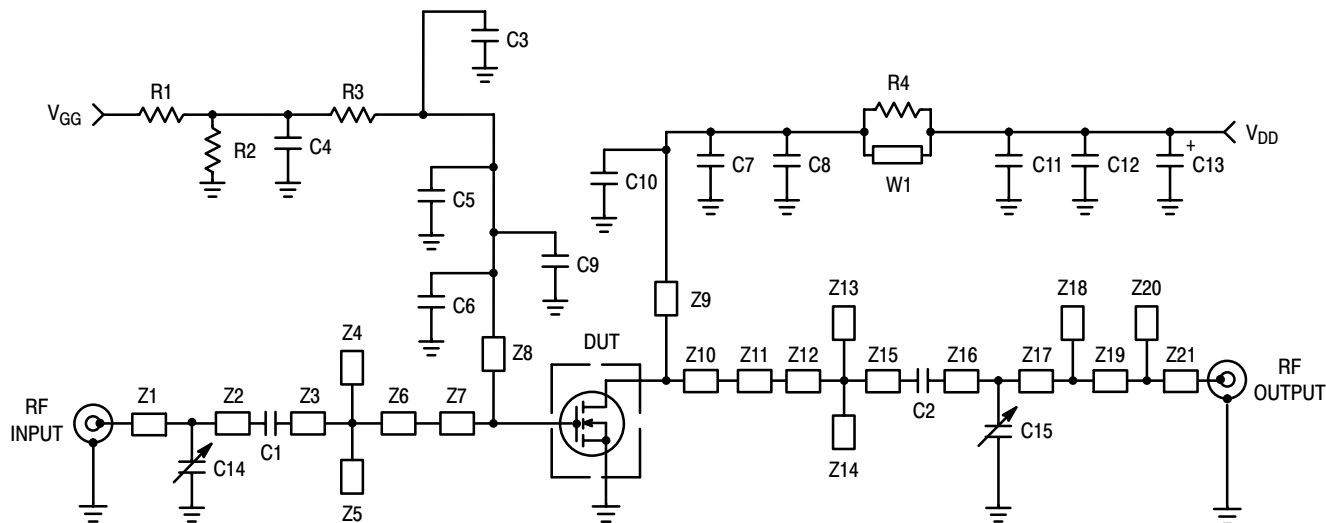

Z1	1.0856" x 0.080" Microstrip	Z12	0.609" x 0.220" Microstrip
Z2	0.130" x 0.080" Microstrip	Z13	0.290" x 0.106" Microstrip
Z3	0.230" x 0.080" Microstrip	Z14	0.290" x 0.106" Microstrip
Z4	0.347" x 0.208" Microstrip	Z15	0.080" x 0.025" Microstrip
Z5	0.090" x 0.208" Microstrip	Z16	1.080" x 0.160" Microstrip
Z6	0.650" x 0.176" Taper	Z17	0.180" x 0.080" Microstrip
Z7	0.623" x 0.610" Microstrip	Z18	0.260" x 0.147" Microstrip
Z8	0.044" x 0.881" Microstrip	Z19	0.500" x 0.080" Microstrip
Z9	0.044" x 0.869" Microstrip	Z20	0.199" x 0.147" Microstrip
Z10	1.076" x 0.446" Microstrip	Z21	0.365" x 0.080" Microstrip
Z11	0.320" x 0.393" Microstrip	PCB	Arlon GX0300-55-22, 0.03", $\epsilon_r = 2.55$

Figure 1. MRF5S21090 Test Circuit Schematic

Table 1. MRF5S21090 Test Circuit Component Designations and Values

Part	Description	Value, P/N or DWG	Manufacturer
C1	9.1 pF Chip Capacitor, B Case	100B9R1CP 500X	ATC
C2	8.2 pF Chip Capacitor, B Case	100B8R2CP 500X	ATC
C3	2.0 pF Chip Capacitor, B Case	100B2R0BP 500X	ATC
C4, C12	0.1 $\mu$ F Chip Capacitors, B Case	CDR33BX104AKWS	Kemet
C5	5.6 pF Chip Capacitor, B Case	100B5R6CP 500X	ATC
C6	5.1 pF Chip Capacitor, B Case	100B5R1CP 500X	ATC
C7	7.5 pF Chip Capacitor, B Case	100B7R5JP 500X	ATC
C8	1.2 pF Chip Capacitor, B Case	100B1R2BP 500X	ATC
C9, C10	0.56 $\mu$ F Chip Capacitors, B Case	700A561MP 150X	ATC
C11	1000 pF Chip Capacitor, B Case	100B102JP 500X	ATC
C13	470 $\mu$ F, 35 V Electrolytic Capacitor	95F4579	Newark
C14, C15	0.4 – 2.5 Variable Capacitors, Gigatrim	44F3367	Newark
R1	1 k $\Omega$ Chip Resistor	D5534M07B1K00R	Newark
R2	560 k $\Omega$ Chip Resistor	CR1206 564JT	Newark
R3, R4	12 $\Omega$ Chip Resistors	RM73B2B120JT	Garrett Electronics
W1	Wire Strap		

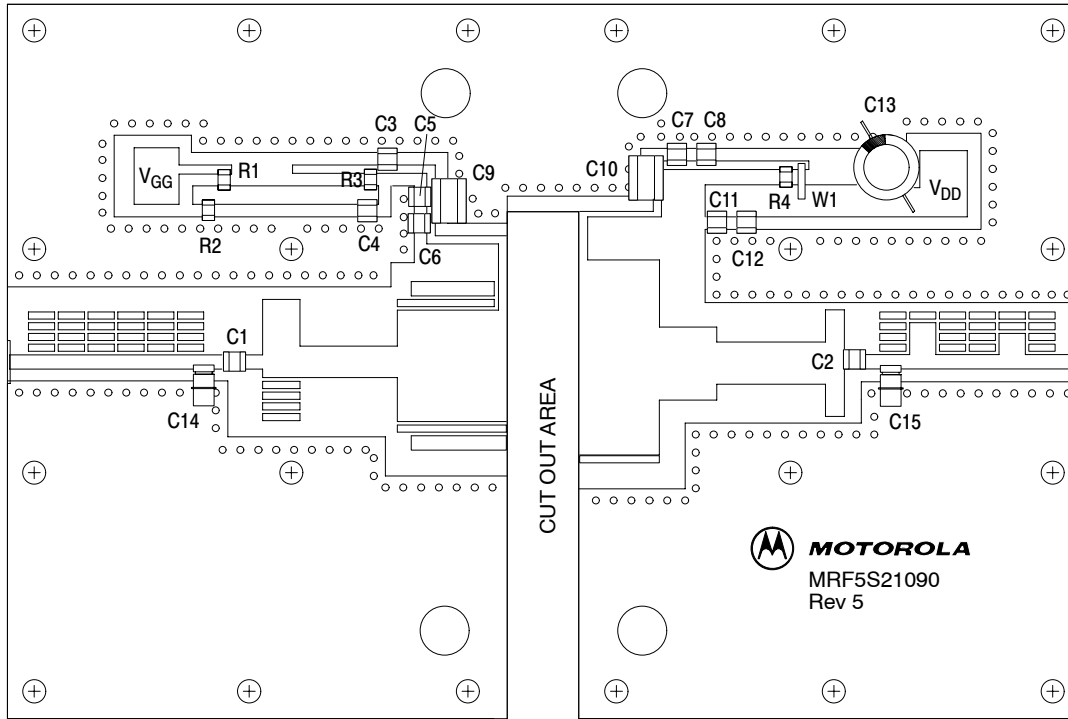

Figure 2. MRF5S21090 Test Circuit Component Layout

Freescale Semiconductor, Inc.

# Freescale Semiconductor, Inc.

## TYPICAL CHARACTERISTICS

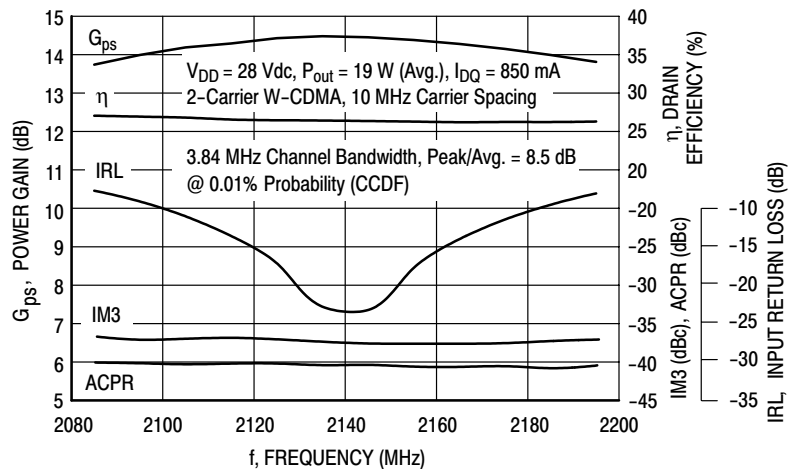

Figure 3. 2-Carrier W-CDMA Broadband Performance

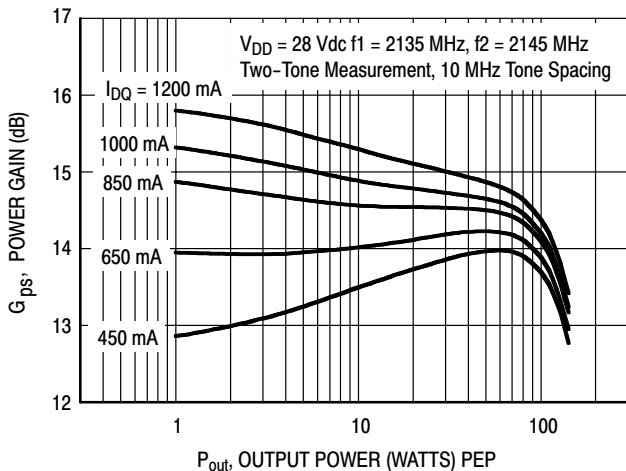

Figure 4. Two-Tone Power Gain versus Output Power

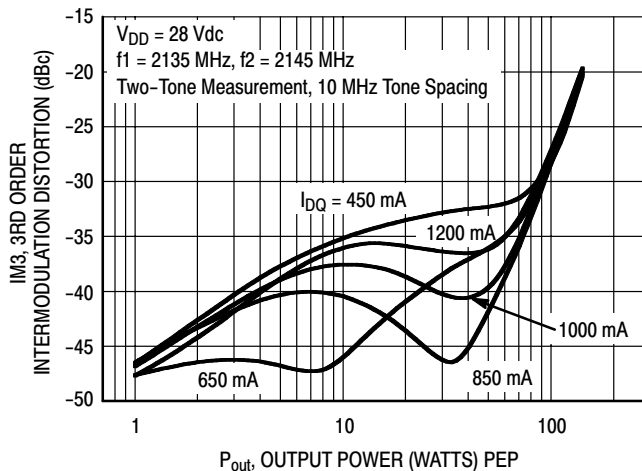

Figure 5. 3rd Order Intermodulation Distortion versus Output Power

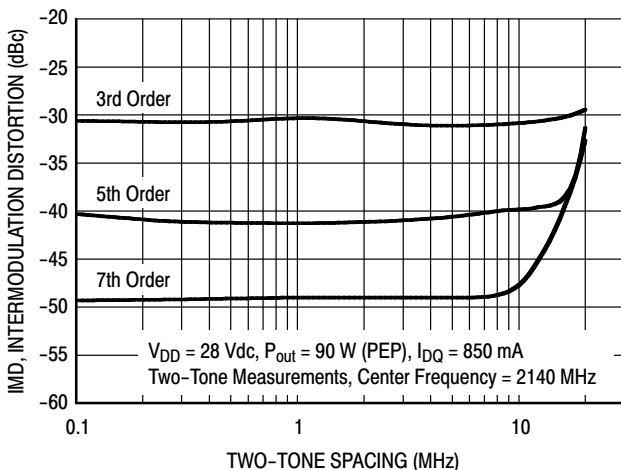

Figure 6. Intermodulation Distortion Products versus Tone Spacing

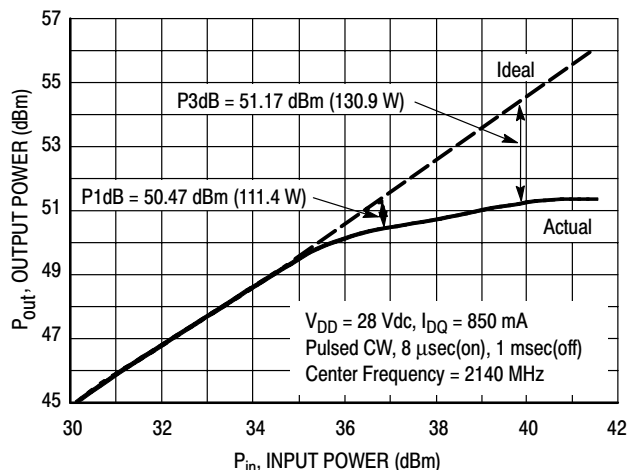
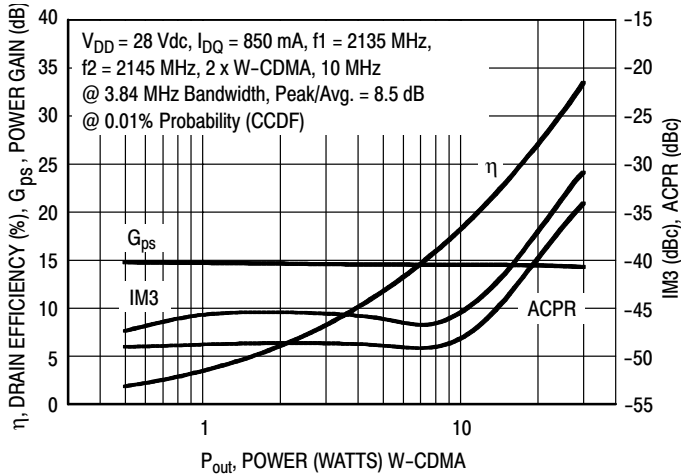

Figure 7. Pulse CW Output Power versus Input Power

# Freescale Semiconductor, Inc.

## TYPICAL CHARACTERISTICS



**Figure 8. 2-Carrier W-CDMA ACPR, IM3, Power Gain and Drain Efficiency versus Output Power**

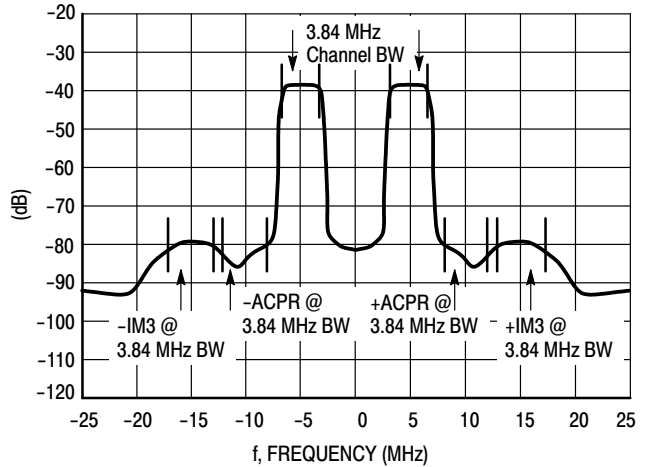

**Figure 9. 2-Carrier W-CDMA Spectrum**

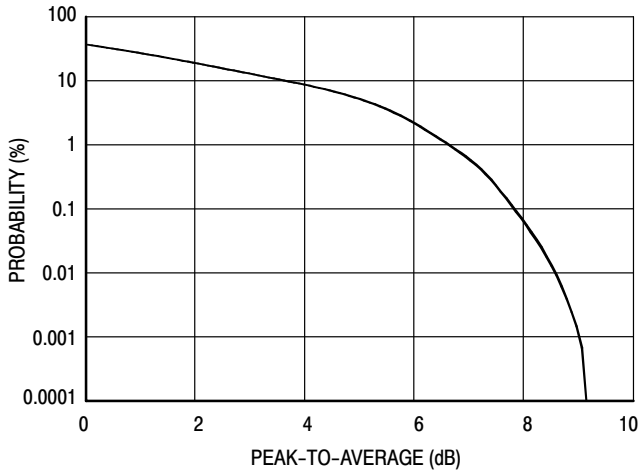

**Figure 10. CCDF W-CDMA 3GPP, Test Model 1, 64 DPCH, 67% Clipping, Single Carrier Test Signal**

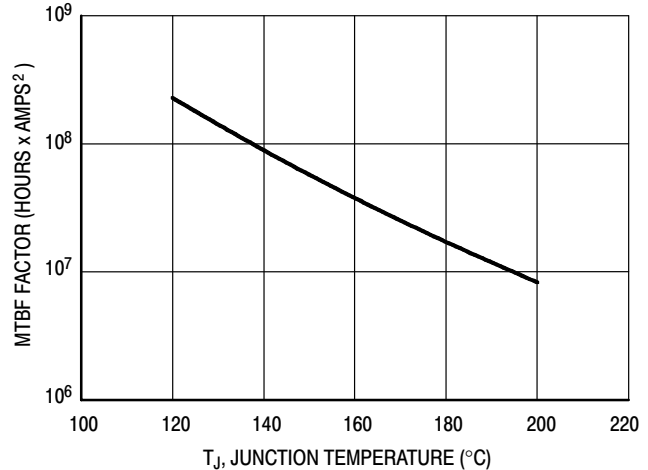

This above graph displays calculated MTBF in hours x ampere<sup>2</sup> drain current. Life tests at elevated temperatures have correlated to better than  $\pm 10\%$  of the theoretical prediction for metal failure. Divide MTBF factor by  $I_D^2$  for MTBF in a particular application.

**Figure 11. MTBF Factor versus Junction Temperature**

Freescale Semiconductor, Inc.

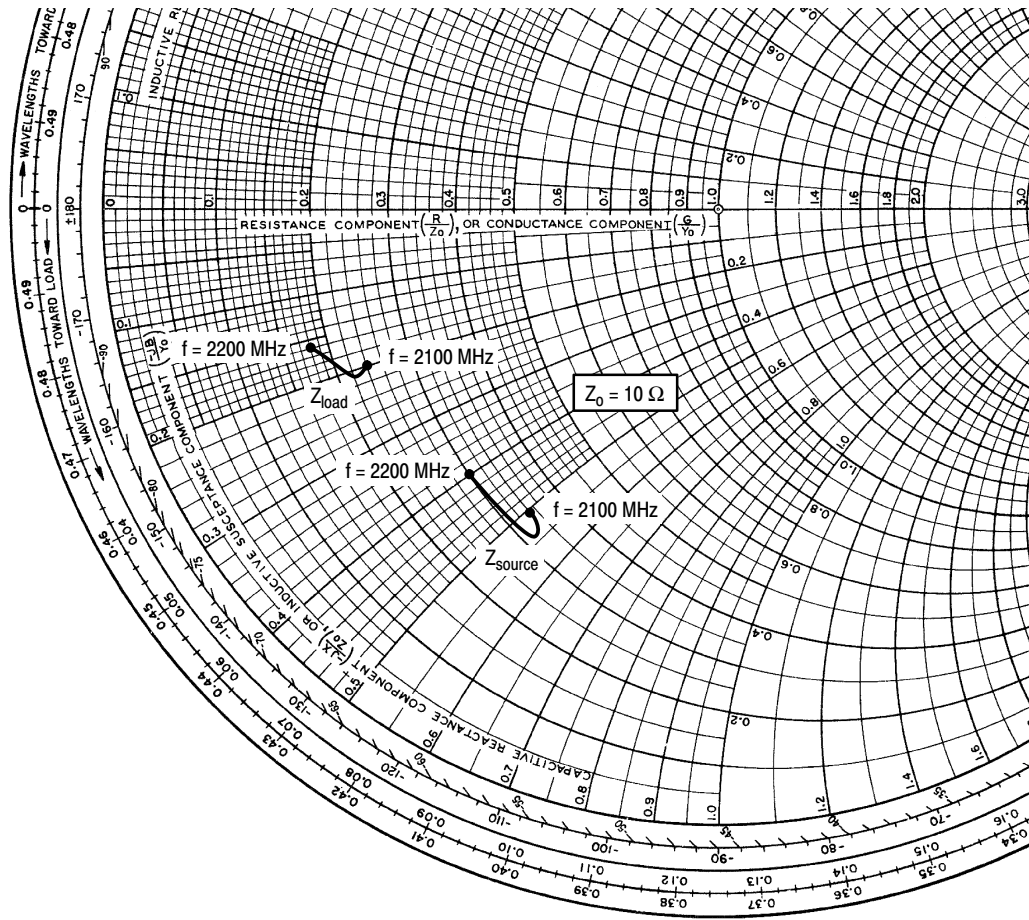

$V_{DD} = 28 \text{ Vdc}$ ,  $I_{DQ} = 850 \text{ mA}$ ,  $P_{out} = 19 \text{ W Avg.}$

f MHz	$Z_{source}$ $\Omega$	$Z_{load}$ $\Omega$
2100	$3.4 - j5.1$	$2.4 - j2.0$
2120	$3.2 - j5.4$	$2.2 - j2.1$
2160	$3.0 - j4.4$	$2.1 - j1.9$
2200	$3.0 - j4.0$	$1.8 - j1.6$

$Z_{source}$  = Test circuit impedance as measured from gate to ground.

$Z_{load}$  = Test circuit impedance as measured from drain to ground.

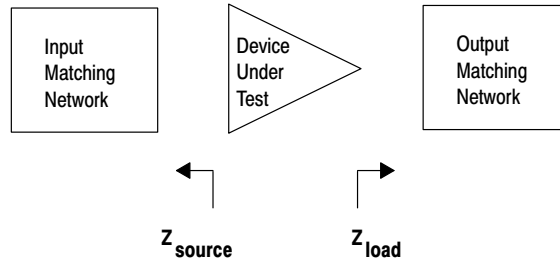

Figure 12. Series Equivalent Input and Output Impedance

**NOTES**



**NOTES**

**NOTES**

# Freescale Semiconductor, Inc.

## PACKAGE DIMENSIONS

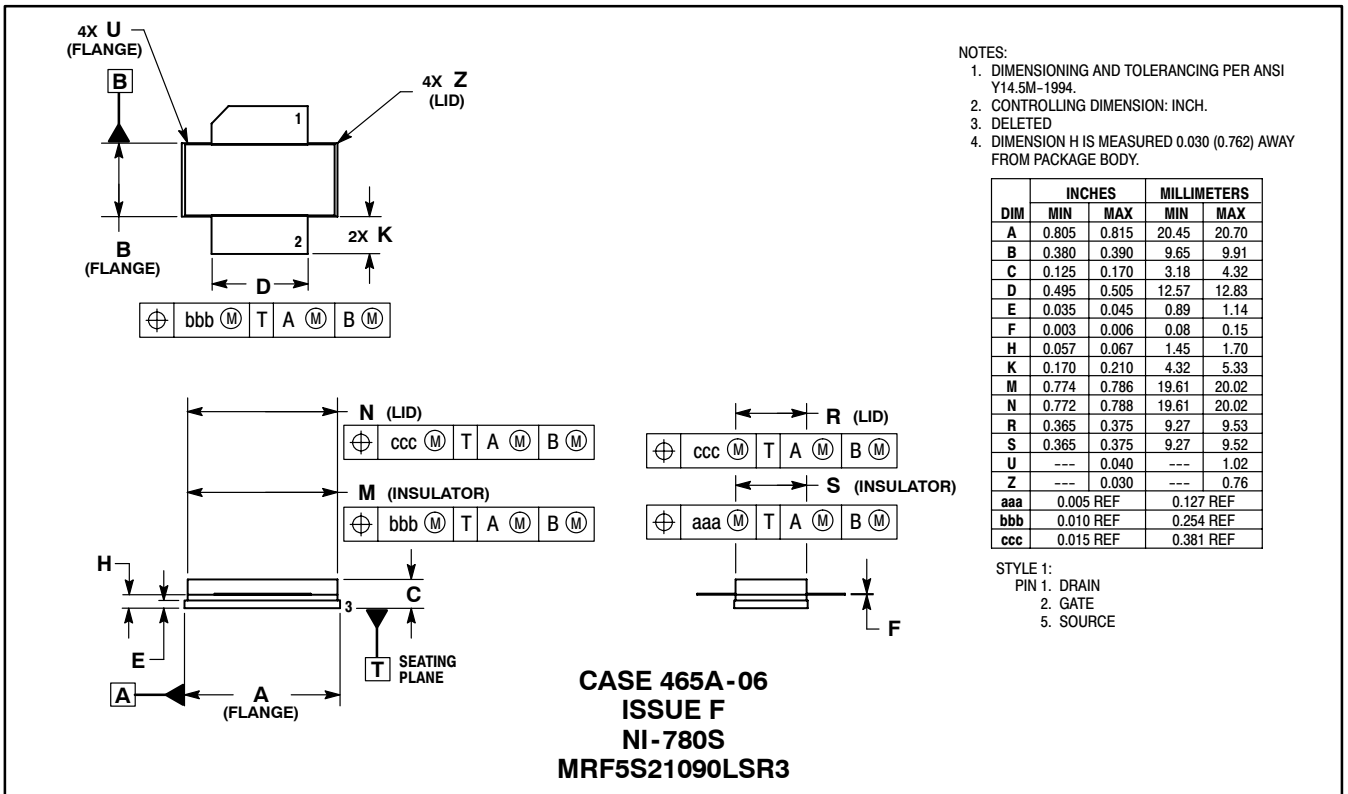
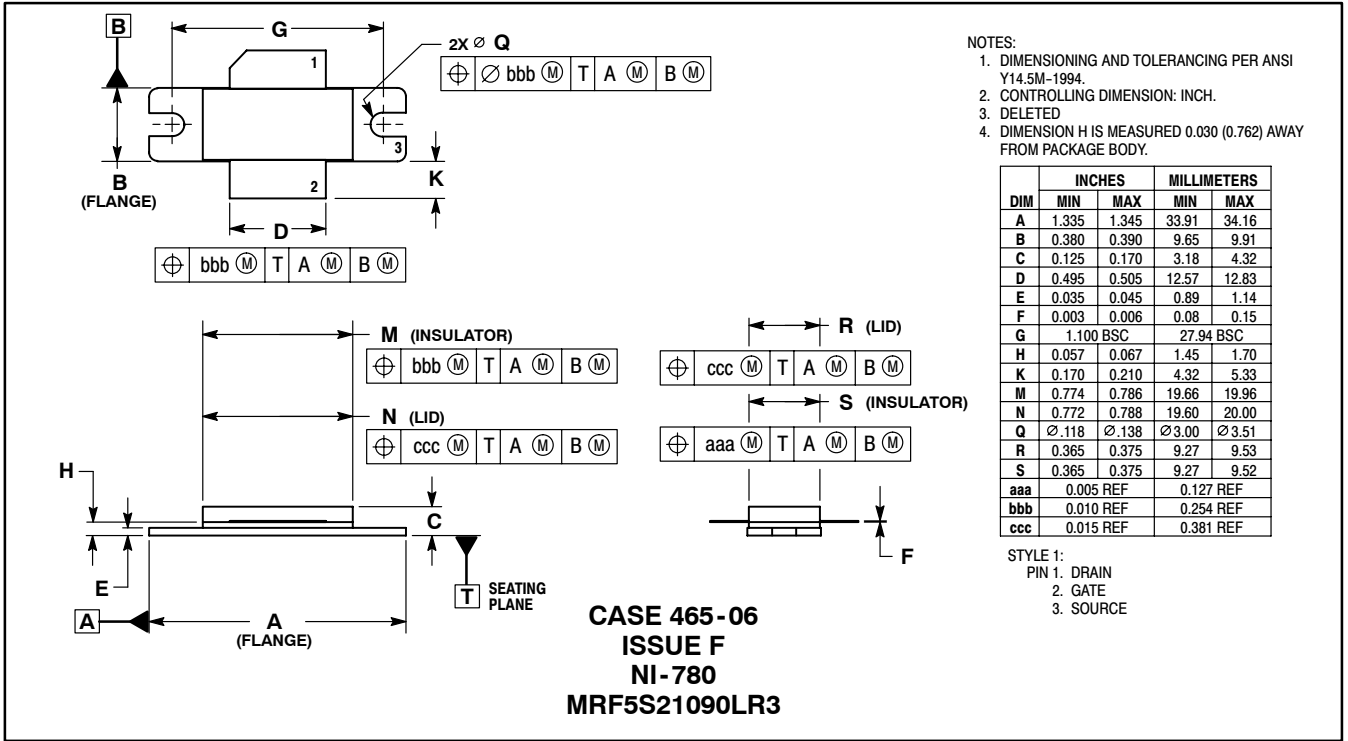

Information in this document is provided solely to enable system and software implementers to use Motorola products. There are no express or implied copyright licenses granted hereunder to design or fabricate any integrated circuits or integrated circuits based on the information in this document.

Motorola reserves the right to make changes without further notice to any products herein. Motorola makes no warranty, representation or guarantee regarding the suitability of its products for any particular purpose, nor does Motorola assume any liability arising out of the application or use of any product or circuit, and specifically disclaims any and all liability, including without limitation consequential or incidental damages. "Typical" parameters that may be provided in Motorola data sheets and/or specifications can and do vary in different applications and actual performance may vary over time. All operating parameters, including "Typicals", must be validated for each customer application by customer's technical experts. Motorola does not convey any license under its patent rights nor the rights of others. Motorola products are not designed, intended, or authorized for use as components in systems intended for surgical implant into the body, or other applications intended to support or sustain life, or for any other application in which the failure of the Motorola product could create a situation where personal injury or death may occur. Should Buyer purchase or use Motorola products for any such unintended or unauthorized application, Buyer shall indemnify and hold Motorola and its officers, employees, subsidiaries, affiliates, and distributors harmless against all claims, costs, damages, and expenses, and reasonable attorney fees arising out of, directly or indirectly, any claim of personal injury or death associated with such unintended or unauthorized use, even if such claim alleges that Motorola was negligent regarding the design or manufacture of the part.

MOTOROLA and the Stylized M Logo are registered in the US Patent and Trademark Office. All other product or service names are the property of their respective owners. Motorola, Inc. is an Equal Opportunity/Affirmative Action Employer.

© Motorola Inc. 2004

#### HOW TO REACH US:

**USA/EUROPE/LOCATIONS NOT LISTED:**  
Motorola Literature Distribution  
P.O. Box 5405, Denver, Colorado 80217  
1-800-521-6274 or 480-768-2130

**JAPAN:** Motorola Japan Ltd.; SPS, Technical Information Center,  
3-20-1, Minami-Azabu, Minato-ku, Tokyo 106-8573, Japan  
81-3-3440-3569

**ASIA/PACIFIC:** Motorola Semiconductors H.K. Ltd.; Silicon Harbour Centre,  
2 Dai King Street, Tai Po Industrial Estate, Tai Po, N.T., Hong Kong  
852-26668334

**HOME PAGE:** <http://motorola.com/semiconductors>



**MOTOROLA**

**For More Information On This Product,  
Go to: [www.freescale.com](http://www.freescale.com)**

**MRF5S21090L/D**