

The RF Sub-Micron MOSFET Line
RF Power Field Effect Transistors
N-Channel Enhancement-Mode Lateral MOSFETs

Designed for W-CDMA base station applications with frequencies from 2110 to 2170 MHz. Suitable for TDMA, CDMA and multicarrier amplifier applications. To be used in Class AB for PCN-PCS/cellular radio and WLL applications.

- Typical 2-carrier W-CDMA Performance for $V_{DD} = 28$ Volts, $I_{DQ} = 1600$ mA, $f_1 = 2.1125$ GHz, $f_2 = 2.1225$ GHz, Channel bandwidth = 3.84 MHz, adjacent channels at ± 5 MHz, ACPR and IM3 measured in 3.84 MHz bandwidth. Peak/Avg = 8.5 dB @ 0.01% probability on CCDF.
 - Output Power — 20 Watts
 - Efficiency — 18%
 - Gain — 13 dB
 - IM3 — -43 dBc
 - ACPR — -45 dBc
- 100% Tested under 2-carrier W-CDMA
- Internally Matched, Controlled Q, for Ease of Use
- High Gain, High Efficiency and High Linearity
- Integrated ESD Protection
- Designed for Maximum Gain and Insertion Phase Flatness
- Capable of Handling 5:1 VSWR, @ 28 Vdc, 2170 MHz, 125 Watts (CW) Output Power
- Excellent Thermal Stability
- Characterized with Series Equivalent Large-Signal Impedance Parameters
- Available in Tape and Reel. R3 Suffix = 250 Units per 56 mm, 13 inch Reel.

MRF21125
MRF21125S
MRF21125SR3

2170 MHz, 125 W, 28 V
LATERAL N-CHANNEL
RF POWER MOSFETs

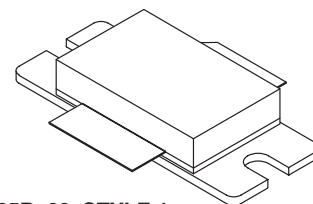

CASE 465B-03, STYLE 1
(NI-880)
(MRF21125)

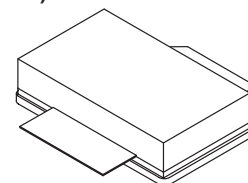

CASE 465C-02, STYLE 1
(NI-880S)
(MRF21125S)

MAXIMUM RATINGS

Rating	Symbol	Value	Unit
Drain-Source Voltage	V_{DSS}	65	Vdc
Gate-Source Voltage	V_{GS}	+15, -0.5	Vdc
Total Device Dissipation @ $T_C = 25^\circ\text{C}$ Derate above 25°C	P_D	330 1.89	Watts $\text{W}/^\circ\text{C}$
Storage Temperature Range	T_{stg}	-65 to +150	$^\circ\text{C}$
Operating Junction Temperature	T_J	200	$^\circ\text{C}$

ESD PROTECTION CHARACTERISTICS

Test Conditions	Class
Human Body Model	2 (Minimum)
Machine Model	M3 (Minimum)

THERMAL CHARACTERISTICS

Characteristic	Symbol	Max	Unit
Thermal Resistance, Junction to Case	$R_{\theta JC}$	0.53	$^\circ\text{C}/\text{W}$

NOTE - **CAUTION** - MOS devices are susceptible to damage from electrostatic charge. Reasonable precautions in handling and packaging MOS devices should be observed.

ELECTRICAL CHARACTERISTICS ($T_C = 25^\circ\text{C}$ unless otherwise noted)

Characteristic	Symbol	Min	Typ	Max	Unit
OFF CHARACTERISTICS					
Drain–Source Breakdown Voltage ($V_{GS} = 0\text{ Vdc}$, $I_D = 100\ \mu\text{Adc}$)	$V_{(BR)DSS}$	65	—	—	Vdc
Gate–Source Leakage Current ($V_{GS} = 5\text{ Vdc}$, $V_{DS} = 0\text{ Vdc}$)	I_{GSS}	—	—	1	μAdc
Zero Gate Voltage Drain Leakage Current ($V_{DS} = 28\text{ Vdc}$, $V_{GS} = 0\text{ Vdc}$)	I_{DSS}	—	—	10	μAdc

ON CHARACTERISTICS

Forward Transconductance ($V_{DS} = 10\text{ Vdc}$, $I_D = 3\text{ Adc}$)	g_{fs}	—	10.8	—	S
Gate Threshold Voltage ($V_{DS} = 10\text{ V}$, $I_D = 300\ \mu\text{A}$)	$V_{GS(th)}$	2	—	4	Vdc
Gate Quiescent Voltage ($V_{DS} = 28\text{ V}$, $I_D = 1300\text{ mA}$)	$V_{GS(Q)}$	2.5	3.9	4.5	Vdc
Drain–Source On–Voltage ($V_{GS} = 10\text{ V}$, $I_D = 1\text{ A}$)	$V_{DS(on)}$	—	0.12	—	Vdc

DYNAMIC CHARACTERISTICS

Reverse Transfer Capacitance (1) ($V_{DS} = 28\text{ Vdc}$, $V_{GS} = 0$, $f = 1\text{ MHz}$)	C_{rss}	—	5.4	—	pF
--	-----------	---	-----	---	----

FUNCTIONAL TESTS (In Motorola Test Fixture) 2–carrier W–CDMA, 3.84 MHz Channel Bandwidth, IM3 measured in 3.84 MHz Bandwidth. Peak/Avg = 8.5 dB @ 0.01% probability on CCDF.

Common–Source Amplifier Power Gain ($V_{DD} = 28\text{ Vdc}$, $P_{out} = 20\text{ W Avg}$, 2–carrier W–CDMA, $I_{DQ} = 1600\text{ mA}$, $f_1 = 2112.5\text{ MHz}$, $f_2 = 2122.5\text{ MHz}$ and $f_1 = 2157.5\text{ MHz}$, $f_2 = 2167.5\text{ MHz}$)	G_{ps}	12	13	—	dB
Drain Efficiency ($V_{DD} = 28\text{ Vdc}$, $P_{out} = 20\text{ W Avg}$, 2–carrier W–CDMA, $I_{DQ} = 1600\text{ mA}$, $f_1 = 2112.5\text{ MHz}$, $f_2 = 2122.5\text{ MHz}$ and $f_1 = 2157.5\text{ MHz}$, $f_2 = 2167.5\text{ MHz}$)	η	17	18	—	%
Third Order Intermodulation Distortion ($V_{DD} = 28\text{ Vdc}$, $P_{out} = 20\text{ W Avg}$, 2–carrier W–CDMA, $I_{DQ} = 1600\text{ mA}$, $f_1 = 2112.5\text{ MHz}$, $f_2 = 2122.5\text{ MHz}$ and $f_1 = 2157.5\text{ MHz}$, $f_2 = 2167.5\text{ MHz}$; IM3 measured at $f_1 -15\text{ MHz}$ and $f_2 +15\text{ MHz}$ referenced to carrier channel power.)	IM3	—	–43	–40	dBc
Adjacent Channel Power Ratio ($V_{DD} = 28\text{ Vdc}$, $P_{out} = 20\text{ W Avg}$, 2–carrier W–CDMA, $I_{DQ} = 1600\text{ mA}$, $f_1 = 2112.5\text{ MHz}$, $f_2 = 2122.5\text{ MHz}$ and $f_1 = 2157.5\text{ MHz}$, $f_2 = 2167.5\text{ MHz}$; ACPR measured at $f_1 -10\text{ MHz}$ and $f_2 +10\text{ MHz}$ referenced to carrier channel power.)	ACPR	—	–45	–40	dBc
Input Return Loss ($V_{DD} = 28\text{ Vdc}$, $P_{out} = 20\text{ W Avg}$, 2–carrier W–CDMA, $I_{DQ} = 1600\text{ mA}$, $f_1 = 2112.5\text{ MHz}$, $f_2 = 2122.5\text{ MHz}$ and $f_1 = 2157.5\text{ MHz}$, $f_2 = 2167.5\text{ MHz}$)	IRL	—	–12	–9.0	dB
Output Mismatch Stress ($V_{DD} = 28\text{ Vdc}$, $P_{out} = 125\text{ W CW}$, $I_{DQ} = 1600\text{ mA}$, $f = 2170\text{ MHz}$, $V_{SWR} = 5:1$, All Phase Angles at Frequency of Test)	Ψ	No Degradation In Output Power Before and After Test			

(1) Part is internally matched both on input and output.

ELECTRICAL CHARACTERISTICS — continued ($T_C = 25^\circ\text{C}$ unless otherwise noted)

Characteristic	Symbol	Min	Typ	Max	Unit
TYPICAL TWO-TONE PERFORMANCE (In Motorola Test Fixture)					
Common-Source Amplifier Power Gain ($V_{DD} = 28\text{ Vdc}$, $P_{out} = 125\text{ W PEP}$, $I_{DQ} = 1600\text{ mA}$, $f_1 = 2110\text{ MHz}$, $f_2 = 2120\text{ MHz}$ and $f_1 = 2160\text{ MHz}$, $f_2 = 2170\text{ MHz}$)	G_{ps}	—	12	—	dB
Drain Efficiency ($V_{DD} = 28\text{ Vdc}$, $P_{out} = 125\text{ W PEP}$, $I_{DQ} = 1600\text{ mA}$, $f_1 = 2110\text{ MHz}$, $f_2 = 2120\text{ MHz}$ and $f_1 = 2160\text{ MHz}$, $f_2 = 2170\text{ MHz}$)	η	—	34	—	%
Intermodulation Distortion ($V_{DD} = 28\text{ Vdc}$, $P_{out} = 125\text{ W PEP}$, $I_{DQ} = 1600\text{ mA}$, $f_1 = 2110\text{ MHz}$, $f_2 = 2120\text{ MHz}$ and $f_1 = 2160\text{ MHz}$, $f_2 = 2170\text{ MHz}$)	IMD	—	-30	—	dBc
TYPICAL CW PERFORMANCE					
Common-Source Amplifier Power Gain ($V_{DD} = 28\text{ Vdc}$, $P_{out} = 125\text{ W CW}$, $I_{DQ} = 1600\text{ mA}$, $f = 2170.0\text{ MHz}$)	G_{ps}	—	11.5	—	dB
Drain Efficiency ($V_{DD} = 28\text{ Vdc}$, $P_{out} = 125\text{ W CW}$, $I_{DQ} = 1600\text{ mA}$, $f = 2170.0\text{ MHz}$)	η	—	46	—	%

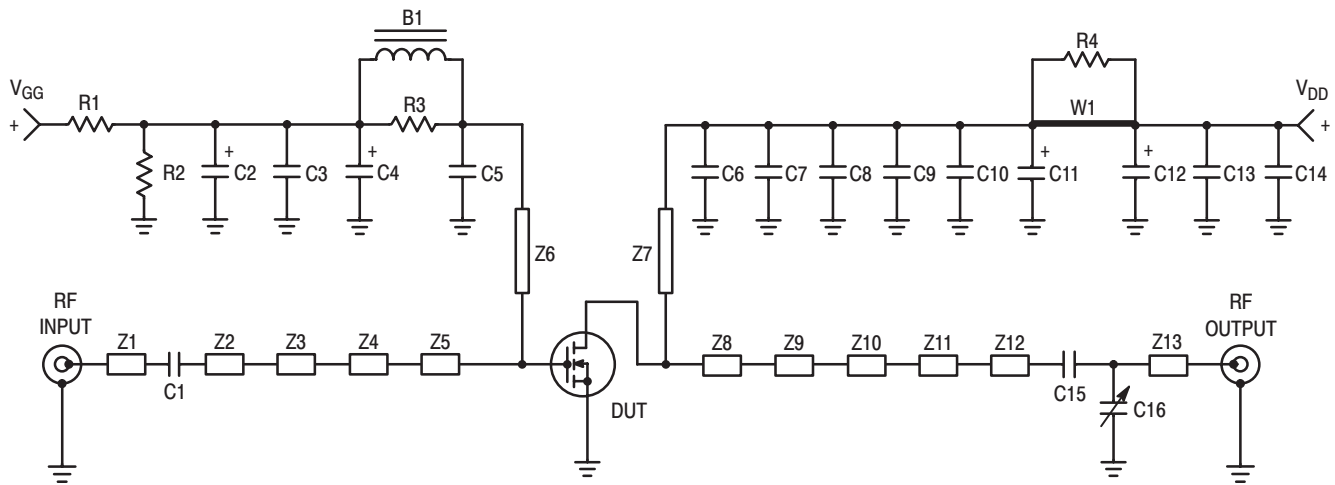

Z1	1.212" x 0.082" Microstrip	Z9	0.179" x 0.219" Microstrip
Z2	0.236" x 0.082" Microstrip	Z10	0.100" x 0.336" Microstrip
Z3	0.086" x 0.254" Microstrip	Z11	0.534" x 0.142" Microstrip
Z4	0.357" x 0.082" Microstrip	Z12	0.089" x 0.080" Microstrip
Z5	0.274" x 1.030" Microstrip	Z13	0.620" x 0.080" Microstrip
Z6	0.466" x 0.050" Microstrip	Raw Board	0.030" Glass Teflon [®] , 2 oz Copper,
Z7	0.501" x 0.050" Microstrip	Material	3" x 5" Dimensions,
Z8	0.600" x 1.056" Microstrip		Arlon GX0300-55-22, $\epsilon_r = 2.55$

Figure 1. MRF21125 Test Circuit Schematic

Table 1. MRF21125 Test Circuit Component Designations and Values

Designators	Description
B1	Ferrite Bead (Square), Fair Rite #2743019447
C1	9.1 pF Chip Capacitor, B Case, ATC #100B9R1CCA500X
C2, C4, C11, C12	22 μ F, 35 V Tantalum Surface Mount Chip Capacitors, Kemet #T491X226K035AS4394
C3, C7	20000 pF Chip Capacitors, B Case, ATC #100B203JCA50X
C5, C14	5.1 pF Chip Capacitors, B Case, ATC #100B5R1CCA500X
C6	100000 pF Chip Capacitor, B Case, ATC #100B104JCA50X
C8	10000 pF Chip Capacitor, B Case, ATC #100B103JCA50X
C9	7.5 pF Chip Capacitor, B Case, ATC #100B7R5CCA500X
C10	1.2 pF Chip Capacitor, B Case, ATC #100B1R2CCA500X
C13	0.1 μ F Chip Capacitor, Kemet #CDR33BX104AKWS
C15	16 pF Chip Capacitor, B Case, ATC #100B160KP500X
C16	0.6 – 4.5 pF Variable Capacitor, Johanson Gigatrim #27271SL
R1	1.0 k Ω , 1/8 W Chip Resistor
R2	560 k Ω , 1/8 W Chip Resistor
R3	4.7 Ω , 1/8 W Chip Resistor
R4	12 Ω , 1/8 W Chip Resistor
W1	Solid Copper Buss Wire, 16 AWG

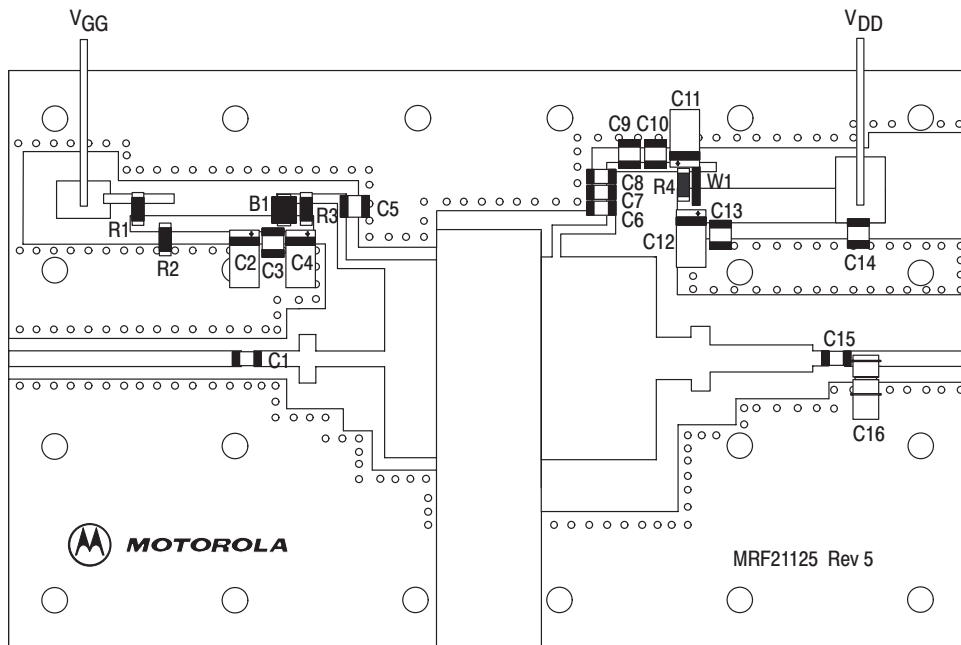

Figure 2. MRF21125 Test Circuit Component Layout

TYPICAL CHARACTERISTICS

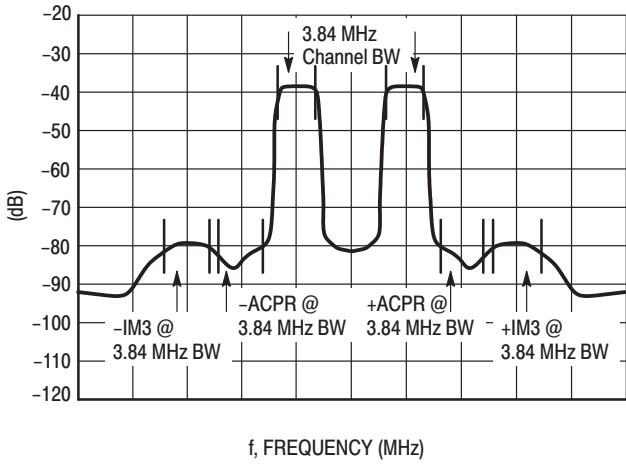

Figure 3. 2 Carrier (10 MHz spacing) W-CDMA Spectrum

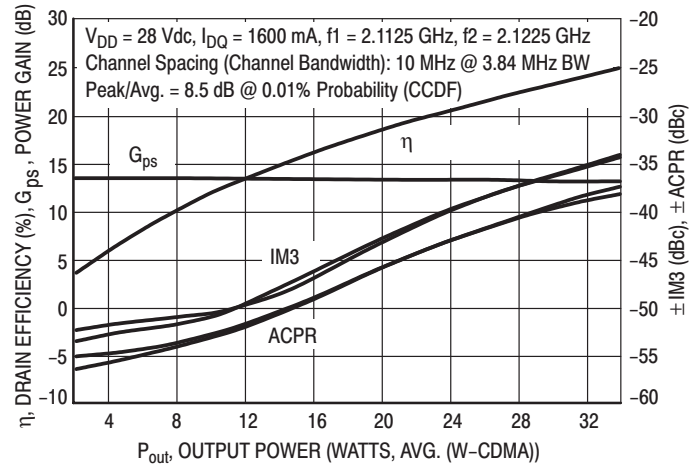

Figure 4. 2 Carrier W-CDMA ACPR, IM3, Power Gain and Drain Efficiency versus Output Power

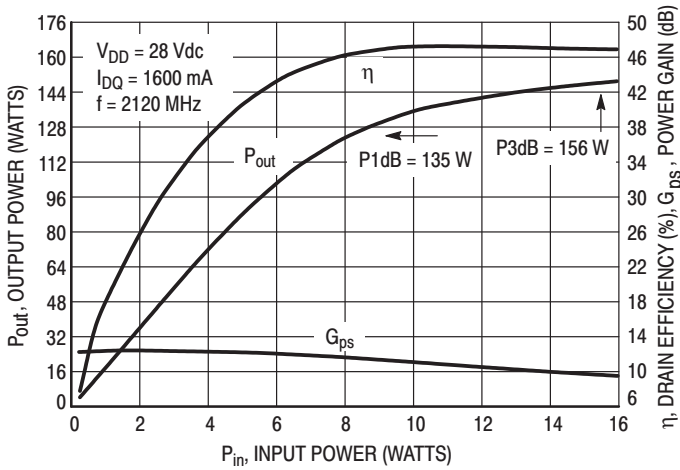

Figure 5. CW Performance

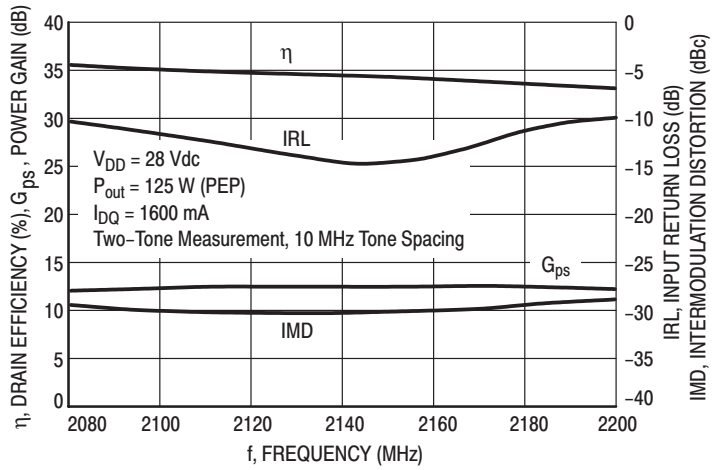

Figure 6. Broadband Linearity Performance

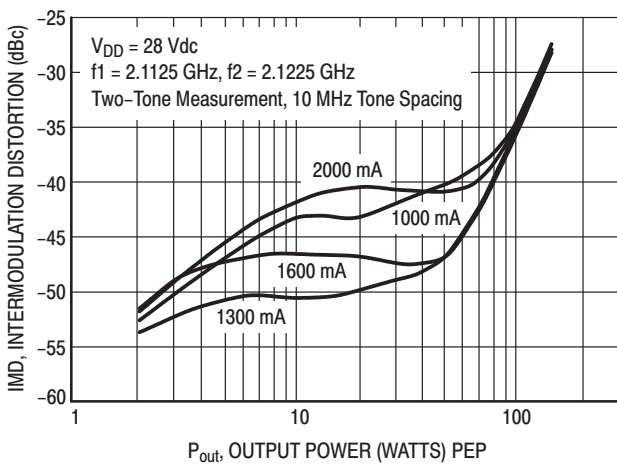

Figure 7. Intermodulation Distortion versus Output Power

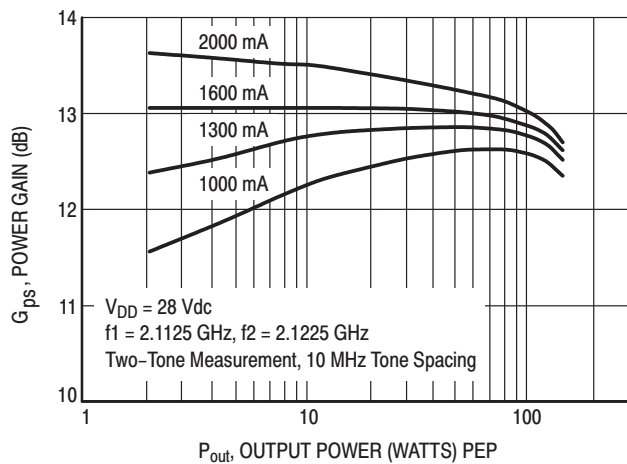
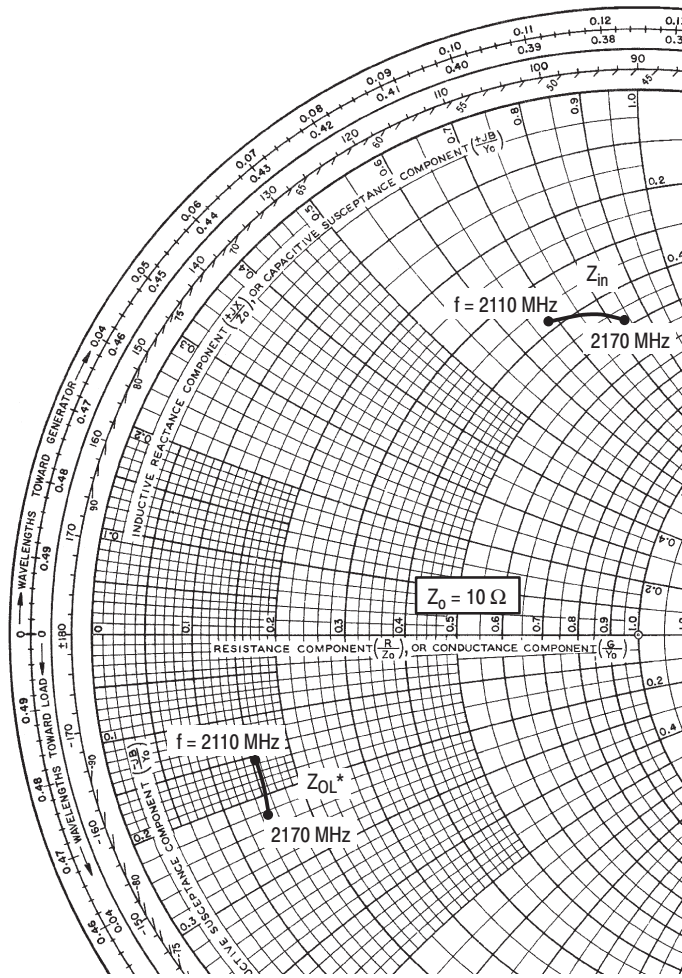

Figure 8. Power Gain versus Output Power



$V_{DD} = 28\text{ V}$, $I_{DQ} = 1600\text{ mA}$, $P_{out} = 20\text{ W (Avg.)}$,
2-Carrier W-CDMA

f MHz	Z_{in} Ω	Z_{OL}^* Ω
2110	$3.81 + j6.86$	$1.56 - j1.58$
2140	$4.33 + j7.90$	$1.53 - j1.90$
2170	$4.84 + j8.46$	$1.48 - j2.26$

Z_{in} = Complex conjugate of source impedance.

Z_{OL}^* = Complex conjugate of the optimum load impedance at a given output power, voltage, IMD, bias current and frequency.

Note 1: Z_{OL}^* was chosen based on tradeoffs between gain, output power, drain efficiency and intermodulation distortion.

Note 2: Measurements were taken on the MRF21125 test circuit with SMA Launchers.

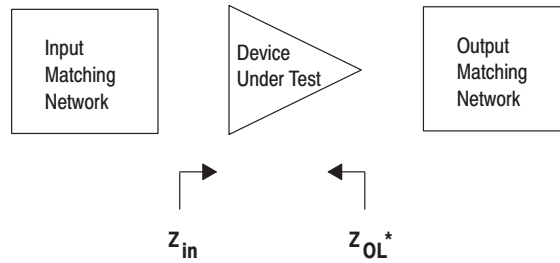

Figure 9. Series Equivalent Input and Output Impedance

NOTES

NOTES

NOTES

PACKAGE DIMENSIONS

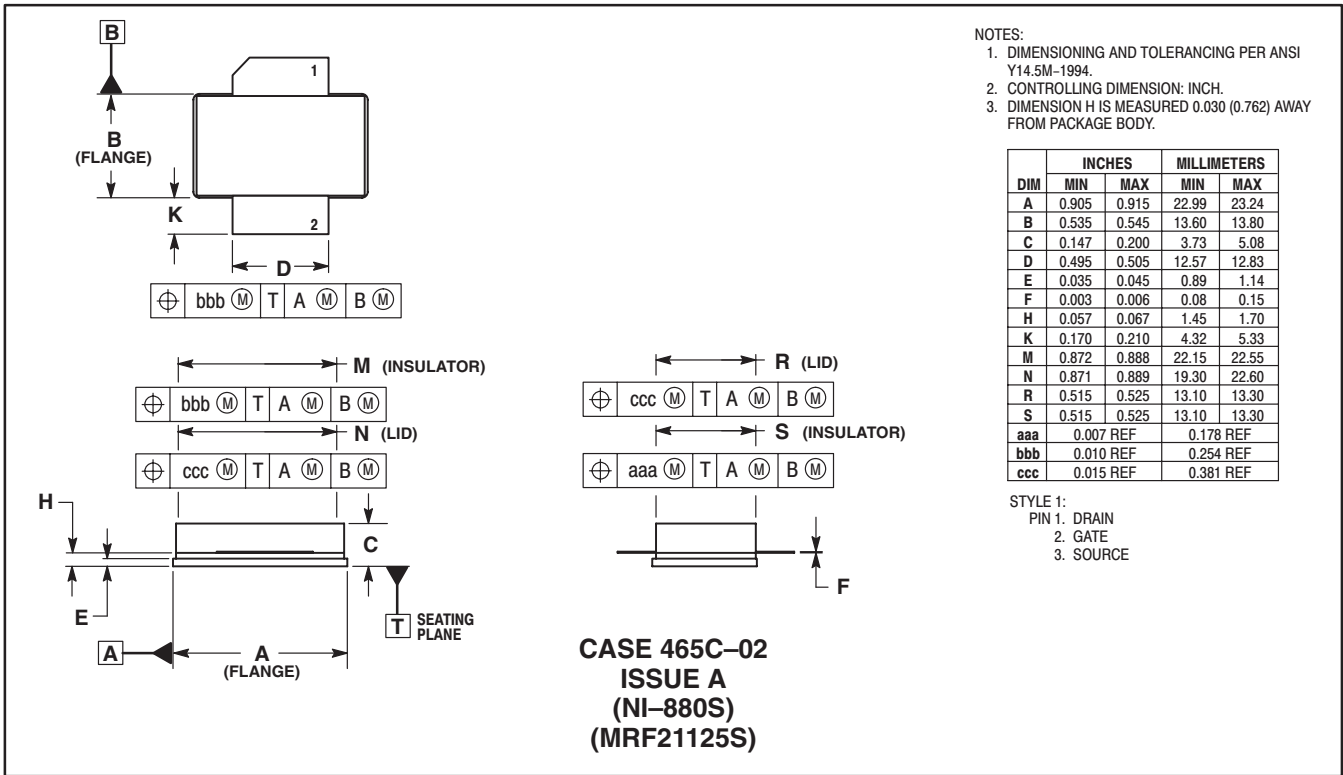
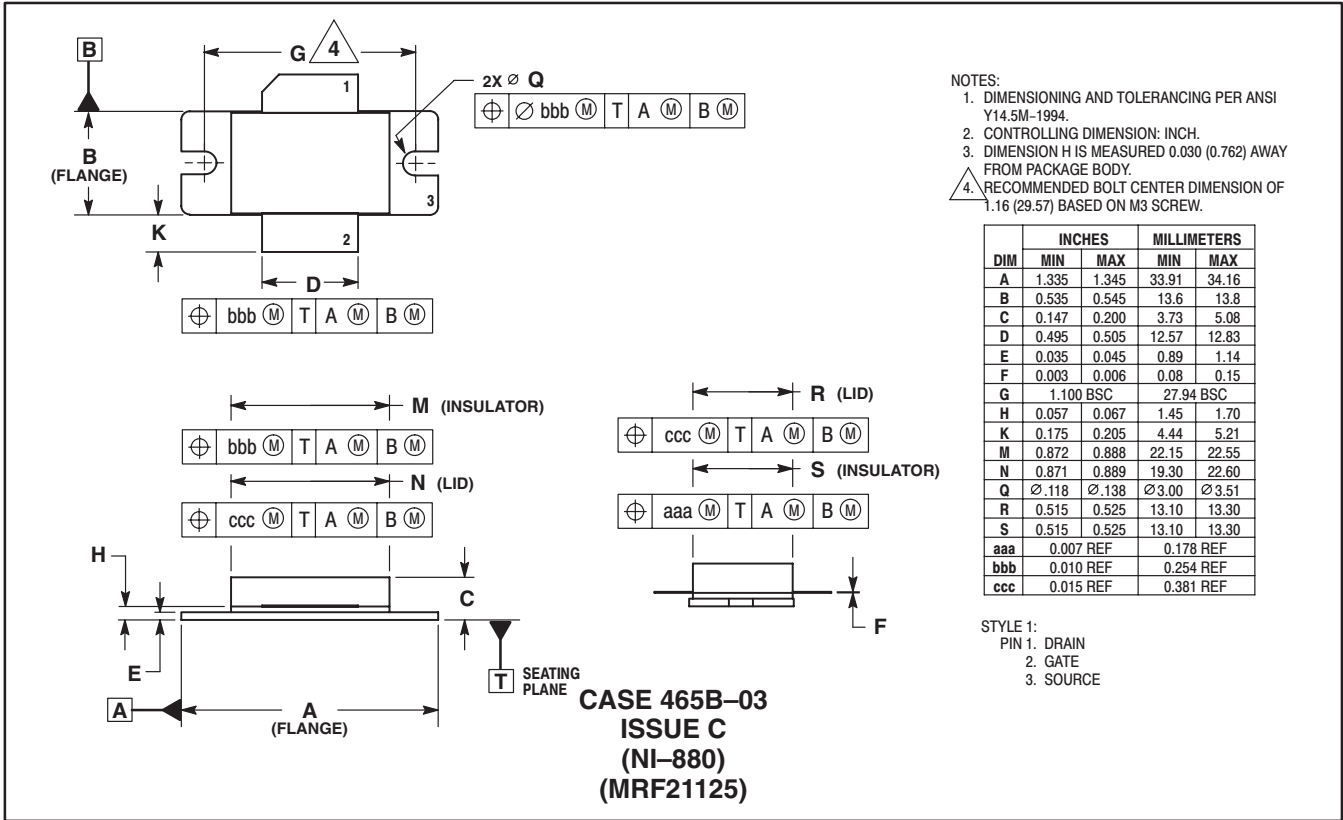

Motorola reserves the right to make changes without further notice to any products herein. Motorola makes no warranty, representation or guarantee regarding the suitability of its products for any particular purpose, nor does Motorola assume any liability arising out of the application or use of any product or circuit, and specifically disclaims any and all liability, including without limitation consequential or incidental damages. "Typical" parameters which may be provided in Motorola data sheets and/or specifications can and do vary in different applications and actual performance may vary over time. All operating parameters, including "Typicals" must be validated for each customer application by customer's technical experts. Motorola does not convey any license under its patent rights nor the rights of others. Motorola products are not designed, intended, or authorized for use as components in systems intended for surgical implant into the body, or other applications intended to support or sustain life, or for any other application in which the failure of the Motorola product could create a situation where personal injury or death may occur. Should Buyer purchase or use Motorola products for any such unintended or unauthorized application, Buyer shall indemnify and hold Motorola and its officers, employees, subsidiaries, affiliates, and distributors harmless against all claims, costs, damages, and expenses, and reasonable attorney fees arising out of, directly or indirectly, any claim of personal injury or death associated with such unintended or unauthorized use, even if such claim alleges that Motorola was negligent regarding the design or manufacture of the part. Motorola, Inc. Motorola, Inc. is an Equal Opportunity/Affirmative Action Employer. MOTOROLA and the  logo are registered in the US Patent & Trademark Office. All other product or service names are the property of their respective owners.

© Motorola, Inc. 2002.

How to reach us:

USA/EUROPE/Locations Not Listed: Motorola Literature Distribution; P.O. Box 5405, Denver, Colorado 80217. 1-303-675-2140 or 1-800-441-2447

JAPAN: Motorola Japan Ltd.; SPS, Technical Information Center, 3-20-1, Minami-Azabu. Minato-ku, Tokyo 106-8573 Japan. 81-3-3440-3569

ASIA/PACIFIC: Motorola Semiconductors H.K. Ltd.; Silicon Harbour Centre, 2 Dai King Street, Tai Po Industrial Estate, Tai Po, N.T., Hong Kong. 852-26668334

Technical Information Center: 1-800-521-6274

HOME PAGE: <http://www.motorola.com/semiconductors/>



MRF21125/D