

# MOS FIELD EFFECT TRANSISTOR

## 2SJ185

### P-CHANNEL MOS FET FOR HIGH-SPEED SWITCHING

#### OUTLINE DIMENSIONS (Unit : mm)

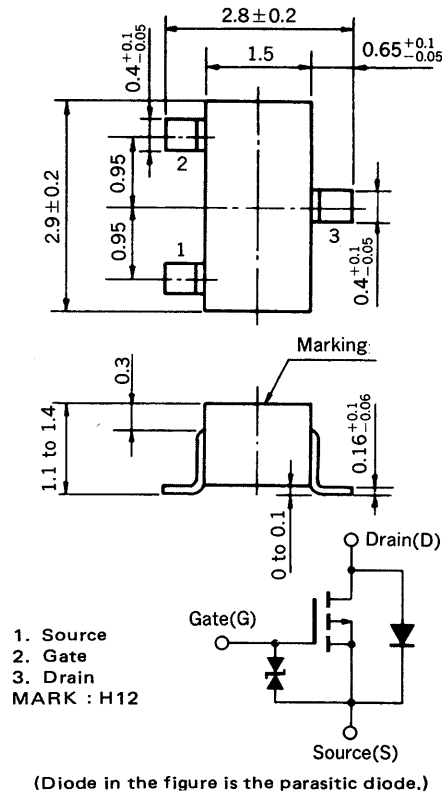

The 2SJ185 is a P-channel vertical type MOS FET which can be driven by 2.5 V power supply.

As the MOS FET is driven by low voltage and does not require consideration of driving current, it is suitable for appliances including VTR cameras and headphone stereos which need power saving.

#### FEATURES

- Directly driven by ICs having a 3 V power supply.
- Not necessary to consider driving current because of its high input impedance.
- Possible to reduce the number of parts by omitting the bias resistor.
- Complementary to 2SK1399

#### QUALITY GRADE

Standard

Please refer to "Quality grade on NEC Semiconductor Devices" (Document number IEI-1209) published by NEC Corporation to know the specification of quality grade on the devices and its recommended applications.

#### ABSOLUTE MAXIMUM RATINGS ( $T_a = 25^\circ\text{C}$ )

CHARACTERISTIC	SYMBOL	RATINGS	UNIT	TEST CONDITIONS
Drain to Source Voltage	$V_{DSS}$	-50	V	$V_{GS} = 0$
Gate to Source Voltage	$V_{GSS}$	$\pm 7.0$	V	$V_{DS} = 0$
Drain Current	$I_D(\text{DC})$	$\pm 100$	mA	
Drain Current	$I_D(\text{pulse})$	$\pm 200$	mA	$PW \leq 10 \text{ ms}$ , Duty Cycle $\leq 50 \%$
Total Power Dissipation	$P_T$	200	mW	
Operating Temperature	$T_{opt}$	-55 to +80	$^\circ\text{C}$	
Storage Temperature	$T_{stg}$	-55 to +150	$^\circ\text{C}$	

ELECTRICAL CHARACTERISTICS (T<sub>a</sub> = 25 °C)

CHARACTERISTIC	SYMBOL	MIN.	TYP.	MAX.	UNIT	CONDITIONS
Drain Cut-off Current	I <sub>DSS</sub>			-10	μA	V <sub>DS</sub> = -50 V, V <sub>GS</sub> = 0
Gate Leakage Current	I <sub>GSS</sub>			±5	μA	V <sub>GS</sub> = ±7.0 V, V <sub>DS</sub> = 0
Gate Cut-off Voltage	V <sub>GS(off)</sub>	-1.2	-1.6	-2.0	V	V <sub>DS</sub> = -3 V, I <sub>D</sub> = -1 μA
Forward Transfer Admittance	y <sub>fs</sub>	* 20	42		mS	V <sub>DS</sub> = -3 V, I <sub>D</sub> = -10 mA
Drain to Source On-State Resistance	R <sub>DS(on)1</sub>		25	40	Ω	V <sub>GS</sub> = -2.5 V, I <sub>D</sub> = -1 mA
Drain to Source On-State Resistance	R <sub>DS(on)2</sub>		13	20	Ω	V <sub>GS</sub> = -4.0 V, I <sub>D</sub> = -10 mA
Input Capacitance	C <sub>iss</sub>		22		pF	V <sub>DS</sub> = -3 V, V <sub>GS</sub> = 0, f = 1 MHz
Output Capacitance	C <sub>oss</sub>		12		pF	
Feedback Capacitance	C <sub>rss</sub>		4		pF	
Turn-On Delay Time	t <sub>d(on)</sub>		80		ns	V <sub>GS(on)</sub> = -3 V, R <sub>G</sub> = 10 Ω, V <sub>DD</sub> = -3 V, I <sub>D</sub> = -20 mA, R <sub>L</sub> = 150 Ω
Rise Time	t <sub>r</sub>		230		ns	
Turn-Off Delay Time	t <sub>d(off)</sub>		40		ns	
Fall Time	t <sub>f</sub>		70		ns	

TYPICAL CHARACTERISTICS (T<sub>a</sub> = 25 °C)

DERATING FACTOR OF FORWARD BIAS SAFE OPERATING AREA

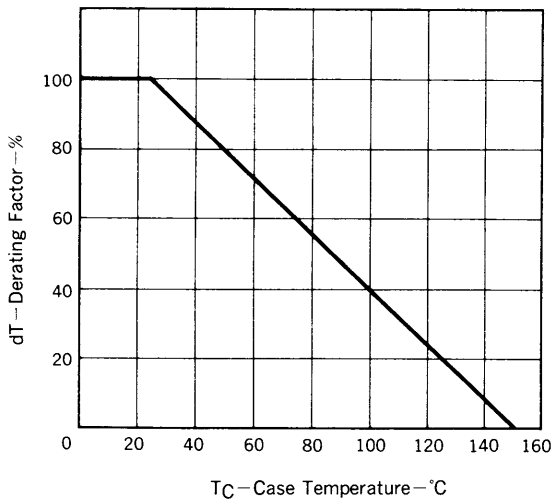

TOTAL POWER DISSIPATION vs. AMBIENT TEMPERATURE

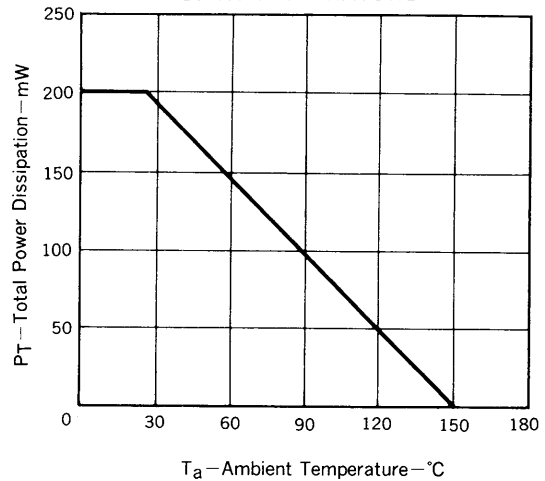

DRAIN CURRENT vs. DRAIN TO SOURCE VOLTAGE

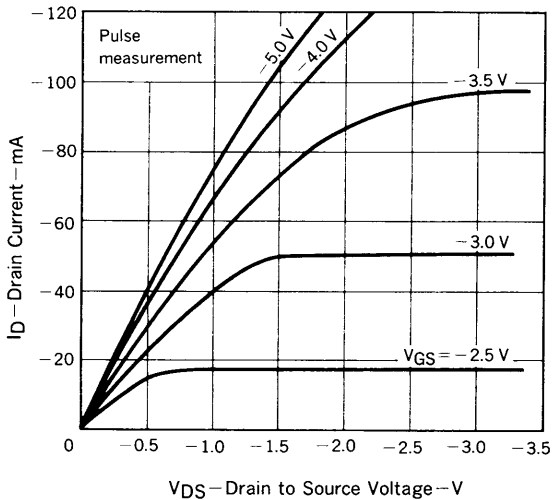

TRANSFER CHARACTERISTICS

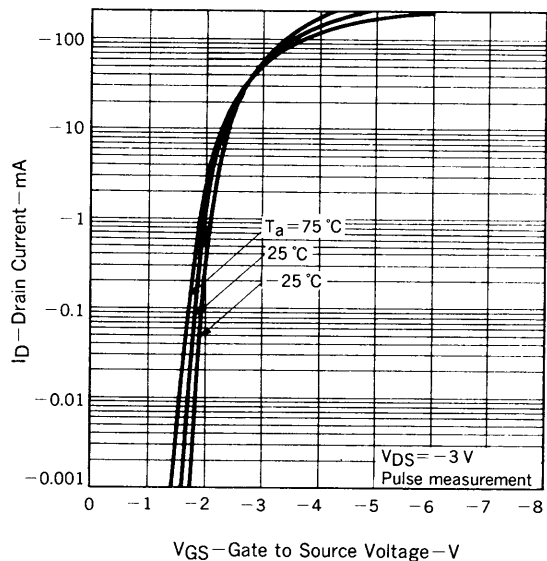

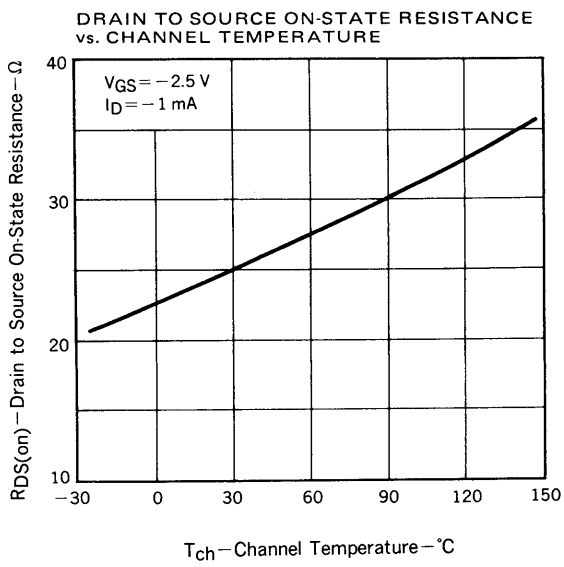
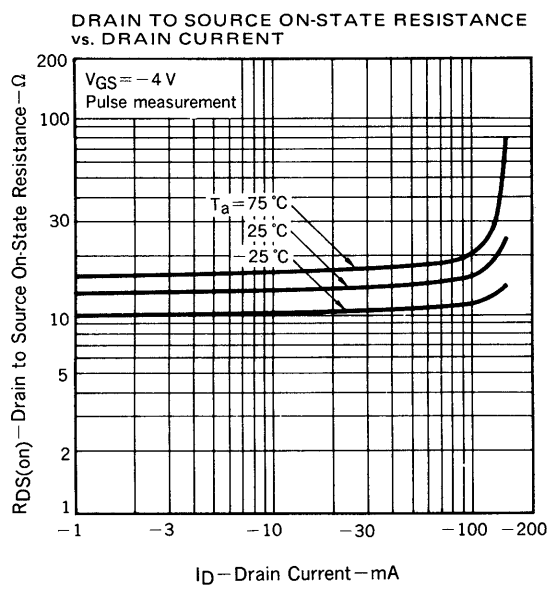
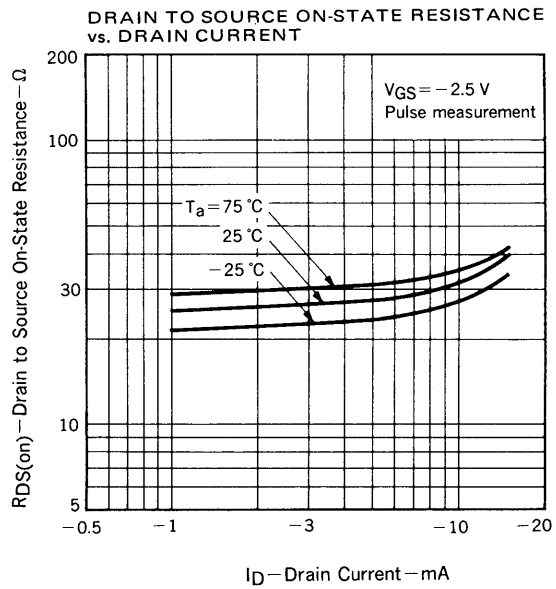
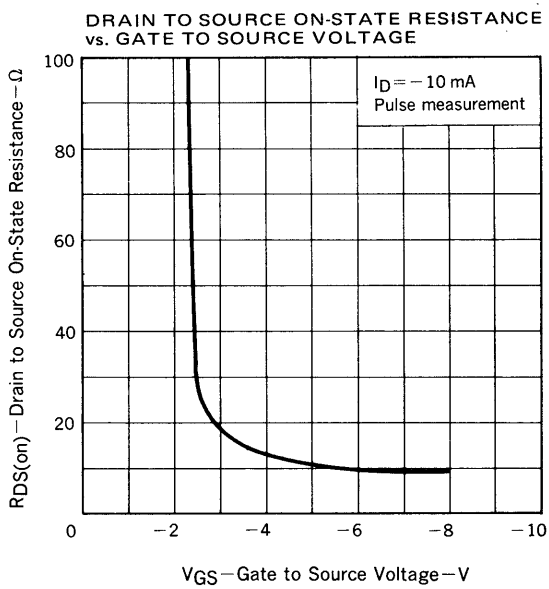
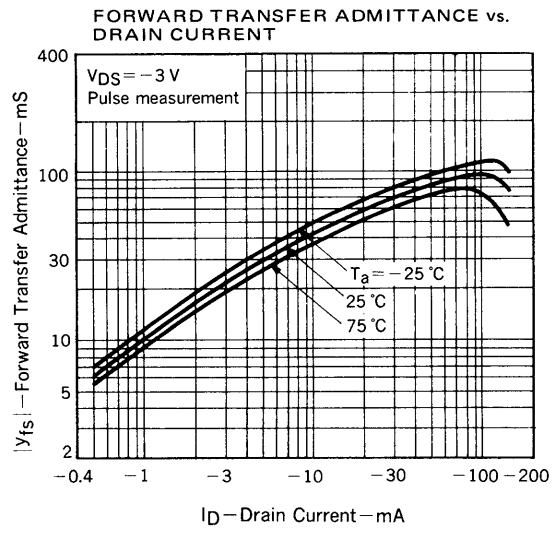
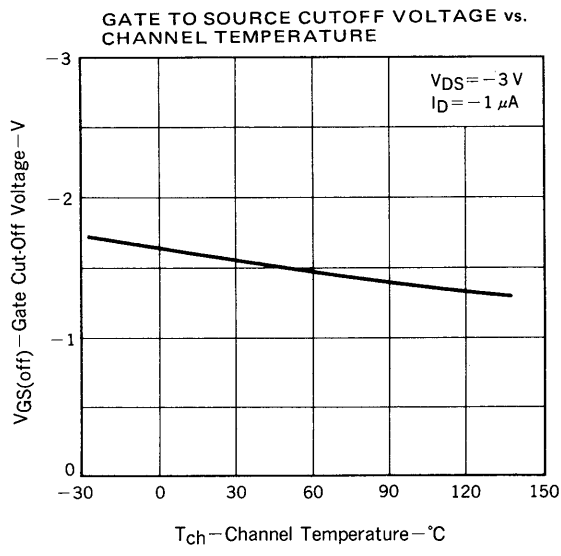

CAPACITANCE vs. DRAIN TO SOURCE VOLTAGE

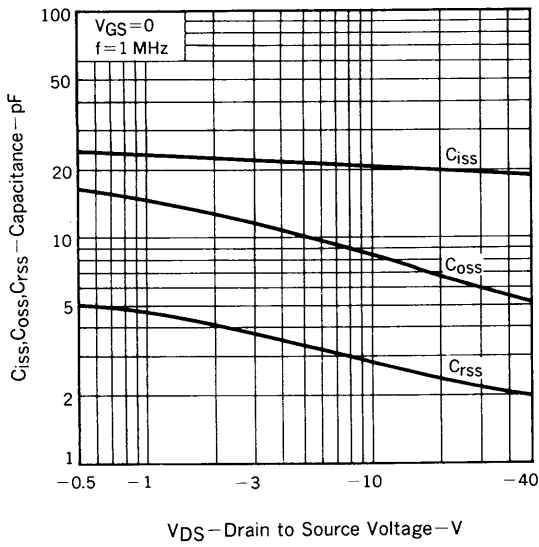

SWITCHING CHARACTERISTICS

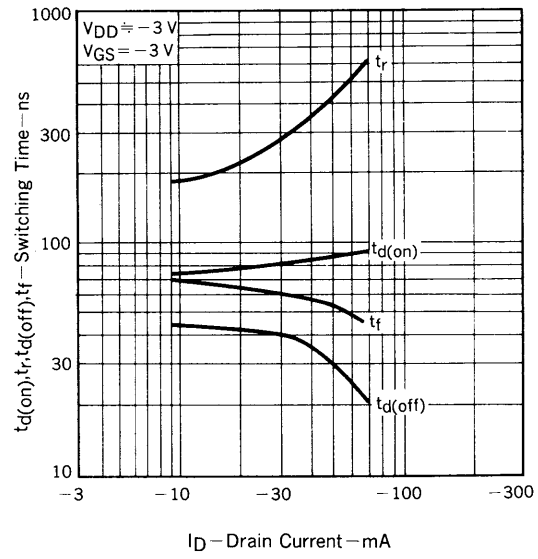

SWITCHING TIME MEASUREMENT CIRCUIT AND CONDITIONS

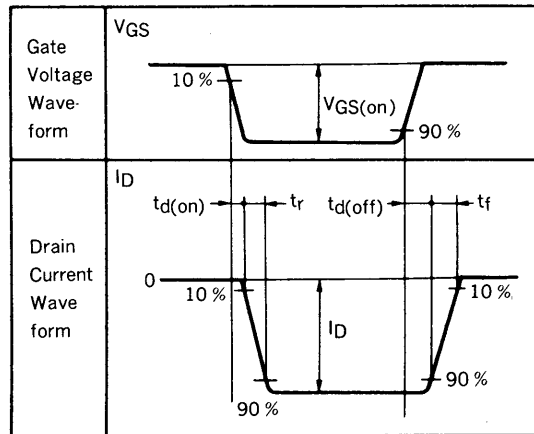
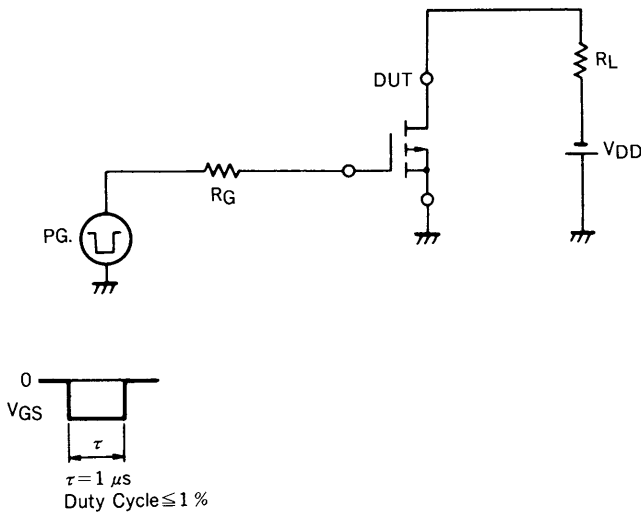

**RECOMMENDED SOLDERING CONDITIONS**

Mounting of this product by soldering should be done under the following conditions.  
Please consult our representatives about soldering methods and conditions other than these.

**SURFACE MOUNT TYPE**

For details of the recommended soldering conditions, see the information document.  
"Device Mounting Manual for Surface Mounting (IEI-616)."

Soldering Method	Soldering Conditions	Symbol for Recommended Conditions
Infrared Reflow	Package peak temp.: 210 °C Soldering time: within 30 sec (above 210 °C) Soldering times: 1, Days limitation: none*	IR30-00
Vapor Phase Soldering	Package peak temp.: 215 °C Soldering time: within 40 sec (above 200 °C) Soldering times: 1, Days limitation: none*	VP15-00
Wave Soldering	Soldering bath temp.: below 260 °C Soldering time: within 10 sec Soldering times: 1, Days limitation: none*	WS60-00

\*: Stored days under storage conditions at 25 °C and below 65 % R.H. after the dry-pack has been opened.

**Note 1** Combination of soldering methods should be avoided.

[MEMO]

No part of this document may be copied or reproduced in any form or by any means without the prior written consent of NEC Corporation. NEC Corporation assumes no responsibility for any errors which may appear in this document.

NEC corporation does not assume any liability for infringement of patents, copyrights or other intellectual property rights of third parties by or arising from use of a device described herein or any other liability arising from use of such device. No license, either express, implied or otherwise, is granted under any patents, copyrights or other intellectual property rights of NEC Corporation or others.

The devices listed in this document are not suitable for use in the field where very high reliability is required including, but not limited to, aerospace equipment, submarine cables, nuclear reactor control systems and life support systems. If customers intend to use NEC devices for above applications or those intended to use "Standard", or "Special" quality grade NEC devices for the applications not intended by NEC, please contact our sales people in advance.

Application examples recommended by NEC Corporation

Standard: Data processing and office equipment, Communication equipment (terminal, mobile). Test and Measurement equipment, Audio and Video equipment, Other consumer products, etc.

Special: Automotive and Transportation equipment, Communication equipment (trunk line), Train and Traffic control devices, industrial robots, Burning control systems, antidisaster systems, anticrime systems etc.