

**MPS-500G****Medical Pressure Sensor**

## Uncompensated, Non-Invasive Medical Pressure Sensor.

The MPS-500G series pressure sensor is a packaged, un-amplified silicon piezo-resistive bridge. Requires external amplification including sensor excitation, calibration and/or temperature compensation. The sense element has four pressure sensitive piezo resistors which are formed on the diaphragm surface of a bulk micro machined silicon chip.

Applied pressure deforms a diaphragm causing piezo-resistors change their resistance. This change in four resistors, which constitute a wheat-stone bridge, results in a pressure proportional voltage.

The pressure sensor die is mounted in a pre-molded plastic cavity package; dual in package (DIP), that has a pressure port allowing pressure to act on the bottom side of the die to sense the pressure medium (air). Binning of packaged sensors are made possible by fully automated customized testers.

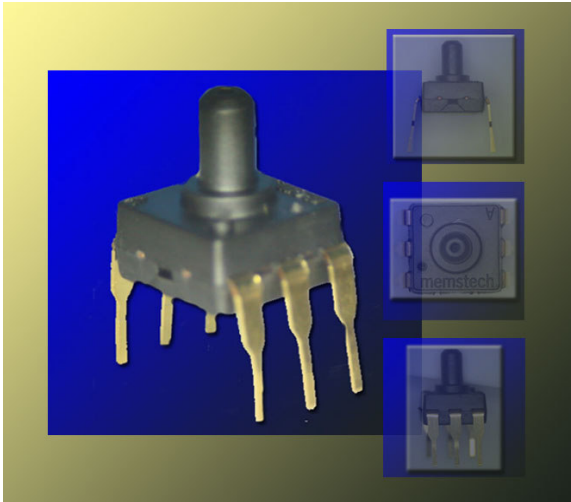

### FEATURES

- High volume, low cost
- Tested AAMI standards
- Excellent offset voltage characteristics
- Excellent span control
- Excellent linearity control
- Dual-in-line-package (DIP)
- Vacuum pressure measurable

### THE MAIN FIELD OF APPLICATIONS

- ✓ Non invasive blood pressure monitors.
- ✓ Asthma peak detector
- ✓ Medical instruments
- ✓ Home use non-invasive blood pressure monitors
- ✓ Home appliance: vacuum cleaners, washing machines

# MPS-500G

## Medical Pressure Sensor

### TECHNICAL DATA - Tested using a drive current of 1.5mA +/- 0.01 mA.

#### Maximum ratings

Specification	Min.	Typ.	Max.	Unit
Operating Temperature	-5	25	80	°C
Storage Temperature	-20	-	100	°C
Over Pressure	-	-	14	PSI
Supply Voltage	-	-	11.7	V
Maximum Drive Current	-	-	3	mA

#### Data

Temperature=22±2°C, Relative humidity=45±5%

Specification	Min.	Typ.	Max.	Unit
Constant Current	-	1.5	3	mA
Operating Pressure Range	0	-	362	mmHg
	0	-	7	psi
	0	-	48	kpa
	0	-	0.5	bar
Over Pressure	-	-	14	psi
	-	-	724	mmHg
	-	-	96	kpa
Zero Pressure Offset Voltage	-	-	1.0	bar
	-10	-	+10	mV
	22	28	34	μV/V/mmHg
Sensitivity	1.2	1.4	1.7	mV/V/psi
	0.2	0.2	0.3	mV/V/kpa
	82	103	124	mV/bar
	40	50	60	mV
Output Voltage Span	40	50	60	mV
Non-linearity	-0.3	-	+0.3	%FS
Hysteresis	-0.3	-	+0.3	%FS
Bridge Resistance	2700	3300	3900	Ω
Temperature coefficient of offset, TCO (0-50°C)	-8.0	-	+8.0	%FS
Temperature coefficient of sensitivity, TCS (0-50°C)	-1.3	-	+1.3	%FS
Offset Stability	-1	-	+1	mmHg
Bin size ( Span voltage)	-	2	-	mV

# MPS-500G

## Medical Pressure Sensor

### CHARACTERISTICS DATA

1. Offset voltage – temperature characteristics  
 Drive current: 1.5 mA; rating  $\pm 8.0\%$  FS

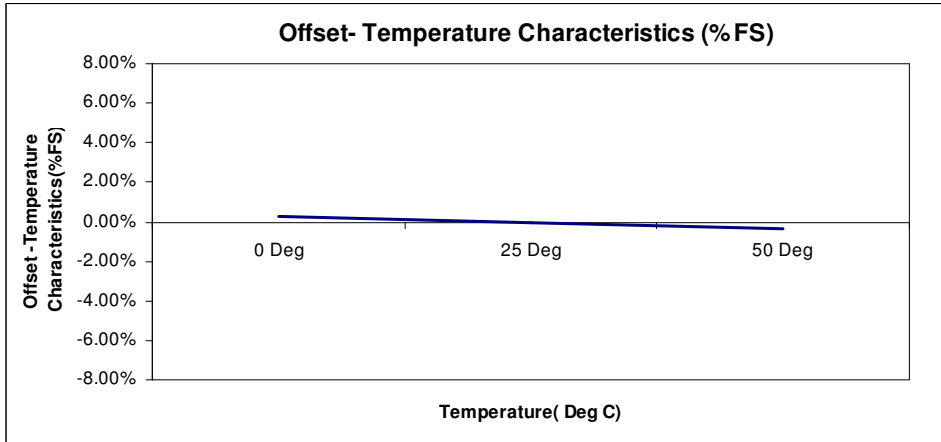

2. Sensitivity – temperature characteristic (%FS)  
 Drive current 1.5 mA; rating  $\pm 1.3\%$  FS

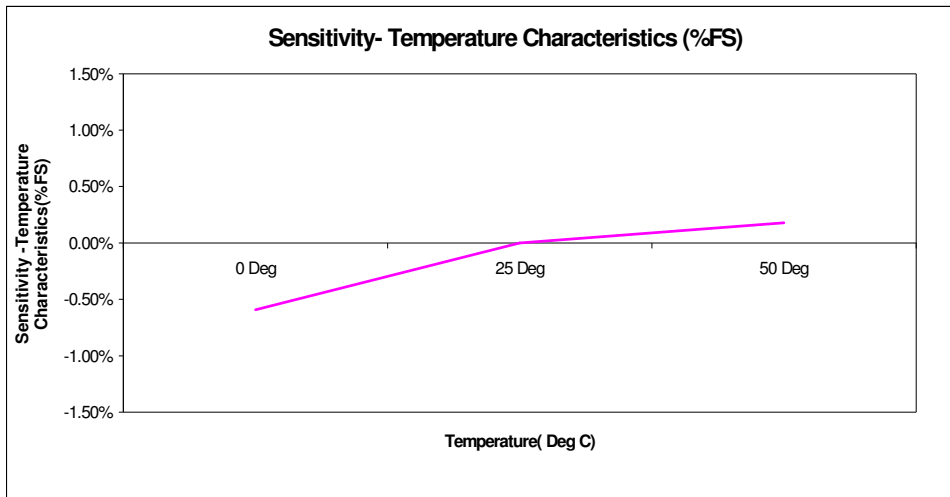

# MPS-500G

## Medical Pressure Sensor

### ELECTRICAL & PIN LAYOUT

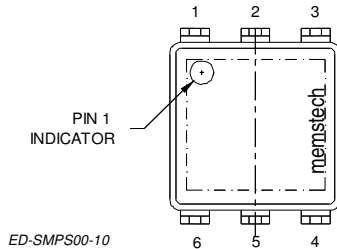

Pad	Symbol	Description
1	V+	Supply + ve
2	O+	Output + ve
3	V-	Input - ve
4	V-	Input - ve
5	O-	Output - ve
6	GND	Ground

### MECHANICAL DIMENSIONS

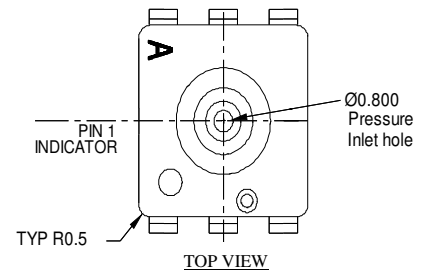
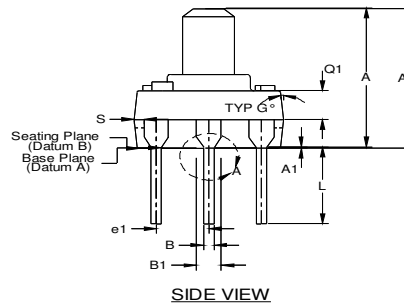
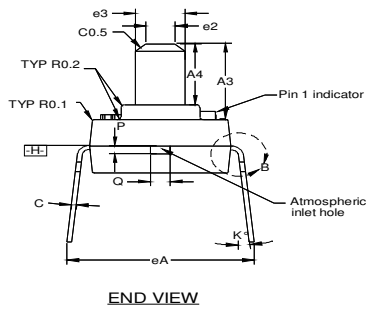

\* Note all dimensions are in mm/inches.

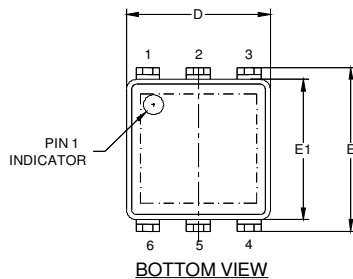

SYMBOL	COMMON DIMENSION (mm)			COMMON DIMENSION (Inch)		
	MIN.	NOM.	MAX.	MIN.	NOM.	MAX.
A *OPTION 1	8.40	8.45	8.50	0.3307	0.3327	0.3346
OPTION 2	9.58	9.63	9.68	0.3772	0.3791	0.3811
A1 *OPTION 1	0.00	0.05	0.10	0.0020	0.0020	0.0039
OPTION 2	1.08	1.13	1.18	0.0425	0.0445	0.0465
A2	8.40	8.50	8.60	0.3307	0.3327	0.3346
A3	4.90	5.00	5.10	0.1929	0.1969	0.2008
A4	3.90	4.00	4.10	0.1535	0.1575	0.1614
B	0.45	0.50	0.55	0.0177	0.0197	0.0217
B1	1.15	1.20	1.25	0.0453	0.0472	0.0492
C	---	0.254	---	---	0.0100	---
D	7.10	7.20	7.20	0.2795	0.2835	0.2835
E	8.35	8.40	8.45	0.3287	0.3307	0.3327
E1	7.10	7.20	7.20	0.2795	0.2835	0.2835
e1	---	2.54	---	---	0.1000	---
e2	1.40	1.50	1.60	0.0551	0.0591	0.0630
e3	2.40	2.50	2.60	0.0945	0.0984	0.1024
eA	8.00	9.50	11.00	0.3150	0.3740	0.4331
G°	3	5	15	3	5	15
K°	---	6	---	---	6	---
L *OPTION 1	4.60	4.65	4.70	0.1811	0.1831	0.1850
OPTION 2	3.42	3.47	3.52	0.1346	0.1366	0.1386
P	0.40	0.50	0.60	0.0157	0.0197	0.0236
Q	0.90	1.00	1.10	0.0354	0.0394	0.0433
Q1	1.65	1.75	1.85	0.0650	0.0689	0.0728
R	---	0.3048	---	---	0.0120	---
R1	---	0.5588	---	---	0.0220	---
S	---	0.46	---	---	0.0181	---
X1°	---	60	---	---	60	---

## MPS-500G

### Medical Pressure Sensor

#### NOTES

1. Pressure media is non-corrosive gas. Type of pressure application is gauge, with bottom pressure application.
2. Positive pressure is applied at port.
3. Soldering process recommendations: due to its small size the thermal resistance of the pressure sensor package type is low. Therefore, take appropriate steps to minimize the effects of external heat. Dip soldering bath: Max. 260°C 500°F, 5 sec soldering iron: 260 to 300°C 500 to 572°F (30W) within 5 sec. When using a non-corrosive resin type of flux ensure that pressure sensor element is not exposed to the flux, and the flux is not allowed to enter inside the package pressure ports or atmospheric ports.
4. PCB post cleaning: as the pressure sensor chip is exposed to atmosphere do not allow cleaning fluid to enter inside the port and avoid ultrasonic cleaning as this may cause breaks or disconnections in the wiring.
5. Environment: consult with MemsTech before using or storing the pressure sensor chip in a place exposed to corrosive gases (including gases given off by organic solvents, sulfites, hydrogen sulfides, etc.) which will adversely affect the performance of the pressure sensor chip.
6. For any additional and or specific test data or information please contact MemsTech.
7. Handling Recommendations:
  - a. Using a pressure range other than what is specified or using other non-industry standard mounting conditions or methods may result in the product non-conformance to specifications.
  - b. Air can be used directly as a pressure medium. Consult with MemsTech before using a corrosive media (including gases given off by organic solvents, sulfites or hydrogen sulfides, etc.) as the pressure medium.
  - c. The pressure sensor chip is positioned inside the pressure inlet. Do not introduce any invasive instruments or other fore pin mates inside the ports or through the pressure inlet as this may damage the sensor or block the inlet. Avoid use when the atmospheric pressure inlet is obstructed or covered.
  - d. Use an operating pressure which is within the rated pressure range. Using a pressure beyond this range may cause damage to the sensor.
  - e. As the pressure sensor chip is not media isolated, consult with MemsTech if it is to be used in a location where it may be introduced to moisture, including post cleaning processes with water, etc.
  - f. Avoid using the pressure sensor in environment's where condensation may form, as this may have an effect upon the electrical output functions of the sensor and cause it to fluctuate under varying environmental conditions.
  - g. The output of the pressure sensor element may be influenced when exposed to light. In case of pressure being applied by means of a transparent tube take appropriate measures to prevent the pressure sensor element from being directly exposure to light.
  - h. Avoid using the pressure sensor product where it will be exposed to ultrasonic or other high-frequency vibration
  - i. Since Electro Static Discharge (ESD) can damage the pressure sensor product, ensure proper handling conditions, and ensure that work stations and operators are properly grounded.

## MPS-500G

### Medical Pressure Sensor

#### **NOTES (CONTINUED)**

8. Terminology
  - a. ZERO PRESSURE OFFSET VOLTAGE (@ 25 °C) Output voltage under no pressure conditions.
  - b. OUTPUT SPAN VOLATGE (@ 25 °C) Difference between rated output rated span pressure application voltage and offset voltage.
  - c. ZIN (@ 25 °C) Input impedance at no pressure conditions
  - d. ZOUT (@ 25 °C) Output impedance at no pressure conditions
  - e. LINEARITY (@ 25 °C) Linearity is expressed in terms of the deviation from the straight line connecting the no pressure condition and rated voltage when the pressure is varied from the no pressure condition to the rated voltage.  
It is expressed as deviation (D1) found when the rated voltage is halved as a ratio to full scale (FS)
  - f. PRESSURE HYSTERESIS (@ 25 °C) Pressure hysteresis is expressed as difference (D2) between the response to an increasing pressure in no pressure condition and a reducing pressure as a ratio to full scale (FS) when the pressure is reduced in the no pressure condition after the pressure has been increased from the no pressure condition to the rated pressure. In other wards the difference in output voltage before the sensor is subjected to rated pressure and immediately after reducing from the rated pressure as a ratio to full scale (FS).
  - g. OFFSET VOLTAGE – TEMPERATURE CHARACTERISTICS. This is the variation in the offset voltage in response to the change in the ambient temperature. It is expressed as the absolute difference ( $\Delta 1$  or  $\Delta 2$ ) between the offset voltage at 0 °C or at 50 °C and offset voltage a 25 °C, which ever is higher, as a ratio to full scale (FS)  $|\Delta 1|/FS \times 100$  or  $|\Delta 2|/FS \times 100$ , which ever is higher.
9. SENSITIVITY – TEMPERATURE CHARACTERISTICS  
This is the variation (full scale <FS> variation) in the sensitivity in response to the change in the ambient temperature. It is expressed as the absolute difference (between FS1 and FS or FS2 and FS) between full scale (FS1,FS2) at 0 °C and 50 °C and full scale at 25 °C (FS) , whichever is higher , as a ratio to full scale(FS) at 25 °C  $|FS1-FS|/FS \times 100$  or  $|FS2-FS|/FS \times 100$ , which ever is higher.
10. BIN NUMBER (@ 25 °C) Bin numbers are defined @ 2 mV intervals of Offset Voltage at Ambient Temperature from -10 mV to 10 mV.
11. Offset Stability is define as the maximum fluctuation of zero pressure offset between 2 seconds and 3 minutes upon supplying current to sensor.