

LMX2485/LMX2485E

50 MHz - 3.0 GHz High Performance Delta-Sigma Low Power Dual PLLatinum™ Frequency Synthesizers with 800 MHz Integer PLL

General Description

The LMX2485 is a low power, high performance delta-sigma fractional-N PLL with an auxiliary integer-N PLL. The device is fabricated using National Semiconductor's advanced process.

With delta-sigma architecture, fractional spurs at lower offset frequencies are pushed to higher frequencies outside the loop bandwidth. The ability to push close in spur and phase noise energy to higher frequencies is a direct function of the modulator order. Unlike analog compensation, the digital feedback technique used in the LMX2485 is highly resistant to changes in temperature and variations in wafer processing. The LMX2485 delta-sigma modulator is programmable up to fourth order, which allows the designer to select the optimum modulator order to fit the phase noise, spur, and lock time requirements of the system.

Serial data for programming the LMX2485 is transferred via a three line high speed (20 MHz) MICROWIRE interface. The LMX2485 offers fine frequency resolution, low spurs, fast programming speed, and a single word write to change the frequency. This makes it ideal for direct digital modulation applications, where the N counter is directly modulated with information. The LMX2485 is available in a 24 lead 4.0 X 4.0 X 0.8 mm LLP package.

Applications

- Cellular phones and base stations
CDMA, WCDMA, GSM/GPRS, TDMA, EDGE, PDC

- Direct digital modulation applications
- Satellite and cable TV tuners
- WLAN Standards

Features

Quadruple Modulus Prescalers for Lower Divide Ratios

- RF PLL: 8/9/12/13 or 16/17/20/21
- IF PLL: 8/9 or 16/17

Advanced Delta Sigma Fractional Compensation

- 12 bit or 22 bit selectable fractional modulus
- Up to 4th order programmable delta-sigma modulator

Features for Improved Lock Times and Programming

- Fastlock / Cycle slip reduction
- Integrated time-out counter
- Single word write to change frequencies with Fastlock

Wide Operating Range

- LMX2485 RF PLL: 500 MHz to 3.0 GHz
- LMX2485E RF PLL: 50 MHz to 3.0 GHz

Useful Features

- Digital lock detect output
- Hardware and software power-down control
- On-chip crystal reference frequency doubler.
- RF phase comparison frequency up to 50 MHz
- 2.5 to 3.6 volt operation with $I_{CC} = 5.0$ mA at 3.0 V

Functional Block Diagram

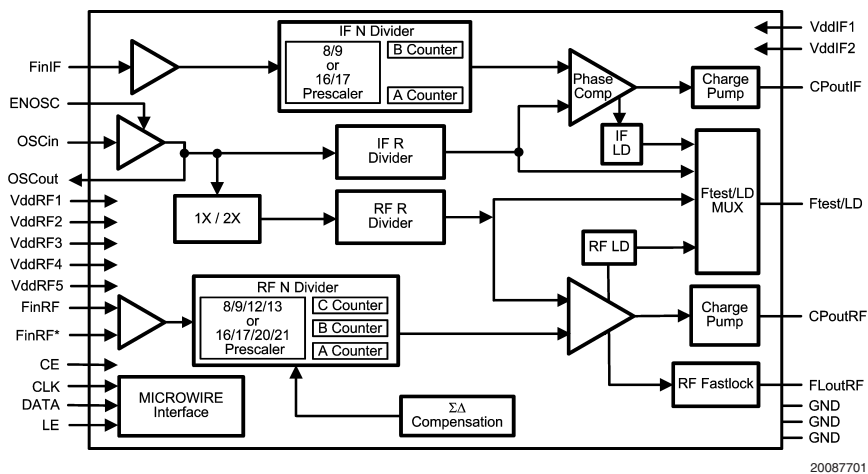

PLLatinum™ is a trademark of National Semiconductor Corporation.

Connection Diagram

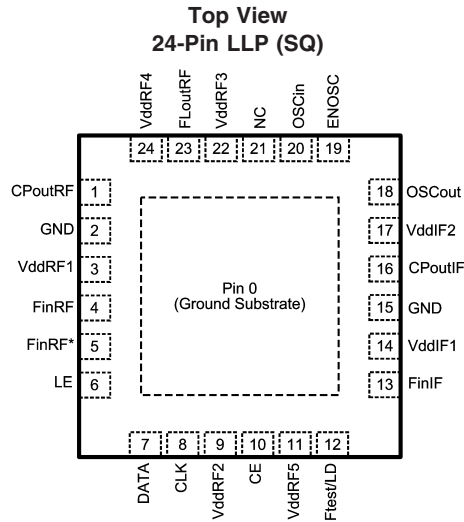

Pin Descriptions

Pin #	Pin Name	I/O	Pin Description
0	GND	-	Ground Substrate. This is on the bottom of the package and must be grounded.
1	CPoutRF	O	RF PLL charge pump output.
2	GND	-	RF PLL analog ground.
3	VddRF1	-	RF PLL analog power supply.
4	FinRF	I	RF PLL high frequency input pin.
5	FinRF*	I	RF PLL complementary high frequency input pin. Shunt to ground with a 100 pF capacitor.
6	LE	I	MICROWIRE Load Enable. High impedance CMOS input. Data stored in the shift registers is loaded into the internal latches when LE goes HIGH
7	DATA	I	MICROWIRE Data. High impedance binary serial data input.
8	CLK	I	MICROWIRE Clock. High impedance CMOS Clock input. Data for the various counters is clocked into the 24 bit shift register on the rising edge
9	VddRF2	-	Power supply for RF PLL digital circuitry.
10	CE	I	Chip Enable control pin. Must be pulled high for normal operation.
11	VddRF5	I	Power supply for RF PLL circuitry.
12	Ftest/LD	O	Test frequency output / Lock Detect.
13	FinIF	I	IF PLL high frequency input pin.
14	VddIF1	-	IF PLL analog power supply.
15	GND	-	IF PLL digital ground.
16	CPoutIF	O	IF PLL charge pump output
17	VddIF2	-	IF PLL power supply.
18	OSCout	O	Buffered output of the OSCin signal.
19	ENOSC	I	Oscillator enable. When this is set to high, the OSCout pin is enabled regardless of the state of other pins or register bits.
20	OSCin	I	Input for TCXO signal.
21	NC	I	This pin must be left open.
22	VddRF3	-	Power supply for RF PLL digital circuitry.
23	FLoutRF	O	RF PLL Fastlock Output. Also functions as Programmable TRI-STATE CMOS output.
24	VddRF4	-	RF PLL analog power supply.

Absolute Maximum Ratings (Notes 1, 2)

Parameter	Symbol	Value			Units
		Min	Typ	Max	
Power Supply Voltage	V_{CC}	-0.3		4.25	V
Voltage on any pin with GND = 0V	V_i	-0.3		$V_{CC}+0.3$	V
Storage Temperature Range	T_s	-65		+150	°C
Lead Temperature (Solder 4 sec.)	T_L			+260	°C

Recommended Operating Conditions

Parameter	Symbol	Value			Units
		Min	Typ	Max	
Power Supply Voltage (Note 1)	V_{CC}	2.5	3.0	3.6	V
Operating Temperature	T_A	-40	25	+85	°C

Note 1: "Absolute Maximum Ratings" indicate limits beyond which damage to the device may occur. "Recommended Operating Conditions" indicate conditions for which the device is intended to be functional, but do not guarantee specific performance limits. For guaranteed specifications and test conditions, see the Electrical Characteristics. The guaranteed specifications apply only for the test conditions listed. The voltage at all the power supply pins of VddRF1, VddRF2, VddRF3, VddRF4, VddRF5, VddIF1 and VddIF2 must be the same. V_{CC} will be used to refer to the voltage at these pins and I_{CC} will be used to refer to the sum of all currents through all these power pins.

Note 2: This Device is a high performance RF integrated circuit with an ESD rating < 2 kV and is ESD sensitive. Handling and assembly of this device should only be done at ESD-free workstations.

Electrical Characteristics ($V_{CC} = 3.0V$; $-40^{\circ}C \leq T_A \leq +85^{\circ}C$ unless otherwise specified)

Symbol	Parameter	Conditions	Value			Units
			Min	Typ	Max	

I_{CC} PARAMETERS

I_{CCRF}	Power Supply Current, RF Synthesizer	IF PLL OFF RF PLL ON Charge Pump TRI-STATE		3.3		mA
I_{CCIF}	Power Supply Current, IF Synthesizer	IF PLL ON RF PLL OFF Charge Pump TRI-STATE		1.7		mA
$I_{CCTOTAL}$	Power Supply Current, Entire Synthesizer	IF PLL ON RF PLL ON Charge Pump TRI-STATE		5.0		mA
I_{CCPD}	Power Down Current	CE = ENOSC = 0V CLK, DATA, LE = 0V		1	10	μA

RF SYNTHESIZER PARAMETERS

f_{FinRF}	Operating Frequency (Note 3)	LMX2485	RF_P = 8	500		2000	MHz
			RF_P = 16	500		3000	
		LMX2485E	RF_P = 8	50		2000	
			RF_P = 16	50		3000	
P_{FinRF}	Input Sensitivity	500 - 3000 MHz		-15		0	dBm
		50 - 500 MHz (LMX2485E only)			-5		
f_{COMP}	Phase Detector Frequency (Note 4)					50	MHz
$I_{CPoutRF}SRCE$	RF Charge Pump Source Current (Note 5)	RF_CPG = 0 $V_{CPoutRF} = V_{CC}/2$			95		μA
		RF_CPG = 1 $V_{CPoutRF} = V_{CC}/2$			190		μA
			μA
		RF_CPG = 15 $V_{CPoutRF} = V_{CC}/2$			1520		μA

Electrical Characteristics ($V_{CC} = 3.0V$; $-40^{\circ}C \leq T_A \leq +85^{\circ}C$ unless otherwise specified) (Continued)

Symbol	Parameter	Conditions	Value			Units
			Min	Typ	Max	
RF SYNTHESIZER PARAMETERS						
$I_{CPoutRF_SINK}$	RF Charge Pump Sink Current (Note 5)	RF_CPG = 0 $V_{CPoutRF} = V_{CC}/2$		-95		μA
		RF_CPG = 1 $V_{CPoutRF} = V_{CC}/2$		-190		μA
			μA
		RF_CPG = 15 $V_{CPoutRF} = V_{CC}/2$		-1520		μA
$I_{CPoutRF_TRI}$	RF Charge Pump TRI-STATE Current Magnitude	$0.5 \leq V_{CPoutRF} \leq V_{CC} - 0.5$		2	10	nA
$ I_{CPoutRF\%MIS} $	Magnitude of RF CP Sink vs. CP Source Mismatch	$V_{CPoutRF} = V_{CC}/2$ $T_A = 25^{\circ}C$	RF_CPG > 2	3	10	%
			RF_CPG \leq 2	3	13	%
$ I_{CPoutRF\%V} $	Magnitude of RF CP Current vs. CP Voltage	$0.5 \leq V_{CPoutRF} \leq V_{CC} - 0.5$ $T_A = 25^{\circ}C$		2	8	%
$ I_{CPoutRF\%T} $	Magnitude of RF CP Current vs. Temperature	$V_{CPoutRF} = V_{CC}/2$		4		%
IF SYNTHESIZER PARAMETERS						
f_{FinIF}	Operating Frequency		75		800	MHz
P_{FinIF}	IF Input Sensitivity		-10		5	dBm
f_{COMP}	Phase Detector Frequency				10	MHz
$I_{CPoutIF_SRCE}$	IF Charge Pump Source Current	$V_{CPoutIF} = V_{CC}/2$		3.5		mA
$I_{CPoutIF_SINK}$	IF Charge Pump Sink Current	$V_{CPoutIF} = V_{CC}/2$		-3.5		mA
$I_{CPoutIF_TRI}$	IF Charge Pump TRI-STATE Current Magnitude	$0.5 \leq V_{CPoutIF} \leq V_{CC} - 0.5$		2	10	nA
$ I_{CPoutIF\%MIS} $	Magnitude of IF CP Sink vs. CP Source Mismatch	$V_{CPoutIF} = V_{CC}/2$ $T_A = 25^{\circ}C$		1	8	%
$ I_{CPoutIF\%V} $	Magnitude of IF CP Current vs. CP Voltage	$0.5 \leq V_{CPoutIF} \leq V_{CC} - 0.5$ $T_A = 25^{\circ}C$		4	10	%
$ I_{CPoutIF\%TEMP} $	Magnitude of IF CP Current vs. Temperature	$V_{CPoutIF} = V_{CC}/2$		4		%
OSCILLATOR PARAMETERS						
f_{OSCin}	Oscillator Operating Frequency	OSC2X = 0	5		110	MHz
		OSC2X = 1	5		20	MHz
V_{OSCin}	Oscillator Input Sensitivity		0.5		V_{CC}	V_{P-P}
I_{OSCin}	Oscillator Input Current		-100		100	μA
SPURS						
	Spurs in band	(Note 6)		-55		dBc

Electrical Characteristics ($V_{CC} = 3.0V$; $-40^{\circ}C \leq T_A \leq +85^{\circ}C$ unless otherwise specified) (Continued)

Symbol	Parameter	Conditions	Value			Units
			Min	Typ	Max	
PHASE NOISE						
L_{F1Hz}^{RF}	RF Synthesizer Normalized Phase Noise Contribution (Note 7)	RF_CPG = 0		-202		dBc/Hz
		RF_CPG = 1		-202		
		RF_CPG = 3		-206		
		RF_CPG = 7		-208		
		RF_CPG = 15		-210		
L_{F1Hz}^{IF}	IF Synthesizer Normalized Phase Noise Contribution			-209		dBc/Hz

DIGITAL INTERFACE (DATA, CLK, LE, ENOSC, CE, Ftest/LD, FLOutRF)

V_{IH}	High-Level Input Voltage		1.6		V_{CC}	V
V_{IL}	Low-Level Input Voltage				0.4	V
I_{IH}	High-Level Input Current	$V_{IH} = V_{CC}$	-1.0		1.0	μA
I_{IL}	Low-Level Input Current	$V_{IL} = 0 V$	-1.0		1.0	μA
V_{OH}	High-Level Output Voltage	$I_{OH} = -500 \mu A$	$V_{CC}-0.4$			V
V_{OL}	Low-Level Output Voltage	$I_{OL} = 500 \mu A$			0.4	V

MICROWIRE INTERFACE TIMING

t_{CS}	Data to Clock Set Up Time	See MICROWIRE Input Timing	25			ns
t_{CH}	Data to Clock Hold Time	See MICROWIRE Input Timing	8			ns
t_{CWH}	Clock Pulse Width High	See MICROWIRE Input Timing	25			ns
t_{CWL}	Clock Pulse Width Low	See MICROWIRE Input Timing	25			ns
t_{ES}	Clock to Load Enable Set Up Time	See MICROWIRE Input Timing	25			ns
t_{EW}	Load Enable Pulse Width	See MICROWIRE Input Timing	25			ns

Note 3: A slew rate of at least 100 V/uS is recommended for frequencies below 500 MHz for optimal performance.

Note 4: For Phase Detector Frequencies above 20 MHz, Cycle Slip Reduction (CSR) may be required. Legal divide ratios are also required.

Note 5: Refer to table in Section 2.4.2 RF_CPG -- RF PLL Charge Pump Gain for complete listing of charge pump currents.

Note 6: In order to measure the in-band spur, the fractional word is chosen such that when reduced to lowest terms, the fractional numerator is one. The spur offset frequency is chosen to be the comparison frequency divided by the reduced fractional denominator. The loop bandwidth must be sufficiently wide to negate the impact of the loop filter. Measurement conditions are: Spur Offset Frequency = 10 kHz, Loop Bandwidth = 100 kHz, Fraction = 1/2000, Comparison Frequency = 20 MHz, RF_CPG = 7, DITH = 0, and a 4th Order Modulator (FM = 0). These are relatively consistent over tuning range.

Note 7: Normalized Phase Noise Contribution is defined as: $L_N(f) = L(f) - 20\log(N) - 10\log(f_{COMP})$ where $L(f)$ is defined as the single side band phase noise measured at an offset frequency, f , in a 1 Hz Bandwidth. The offset frequency, f , must be chosen sufficiently smaller than the PLL loop bandwidth, yet large enough to avoid substantial phase noise contribution from the reference source. Measurement conditions are: Offset Frequency = 11 kHz, Loop Bandwidth = 100 kHz for RF_CPG = 7, Fraction = 1/2000, Comparison Frequency = 20 MHz, FM = 0, DITH = 0.

MICROWIRE INPUT TIMING DIAGRAM

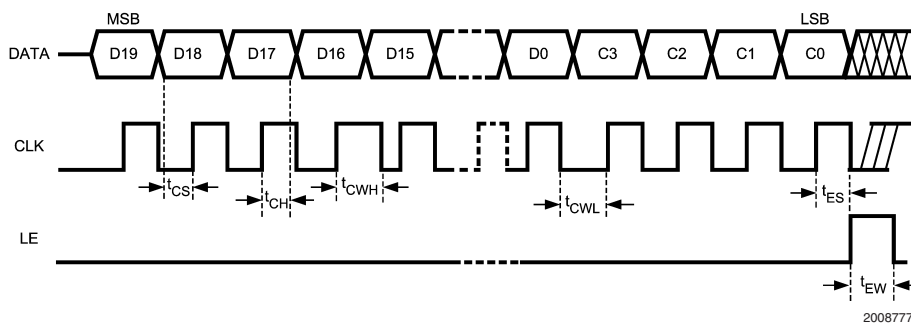

Typical Performance Characteristics : Sensitivity (Note 8)

RF PLL Fin Sensitivity
 $T_A = 25^\circ\text{C}$, RF_P = 16

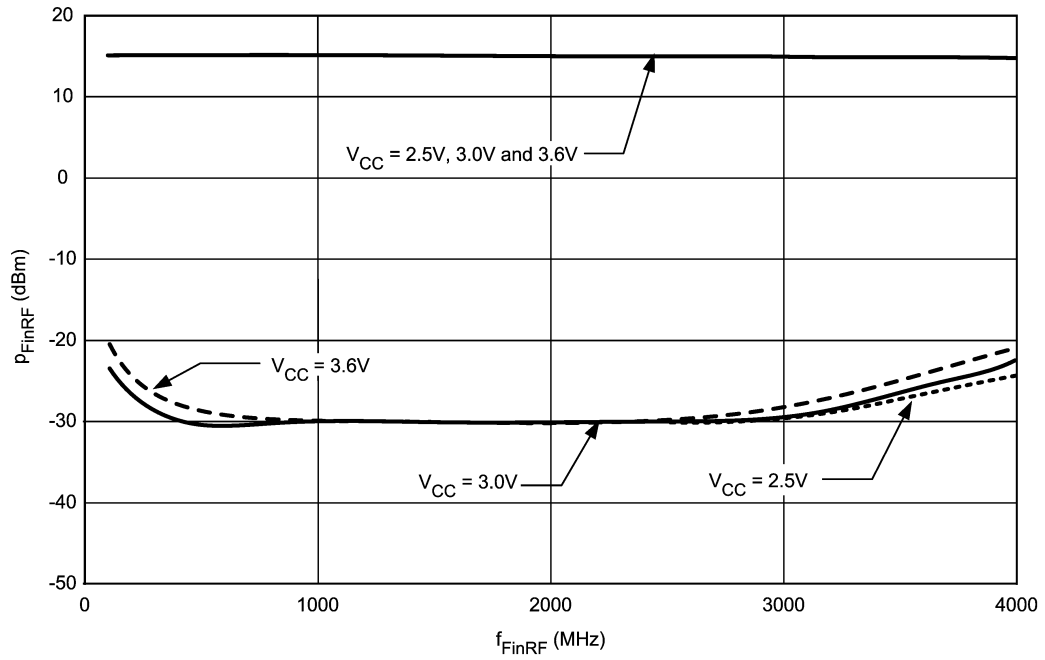

20087745

RF PLL Fin Sensitivity
 $V_{CC} = 3.0 V$, RF_P = 16

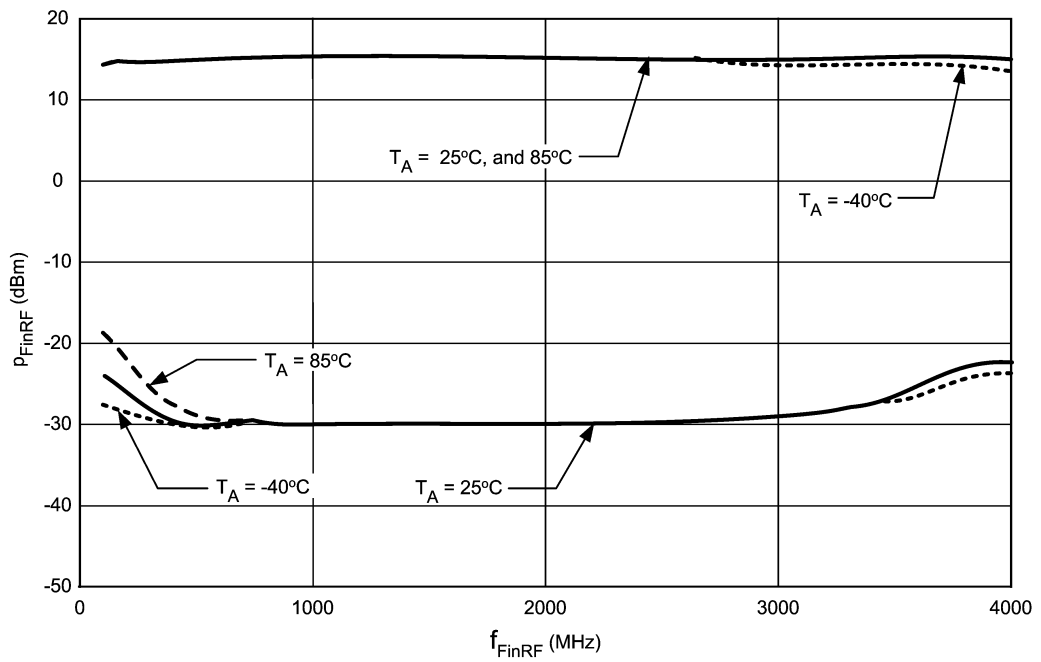

20087746

Typical Performance Characteristics : Sensitivity (Note 8) (Continued)

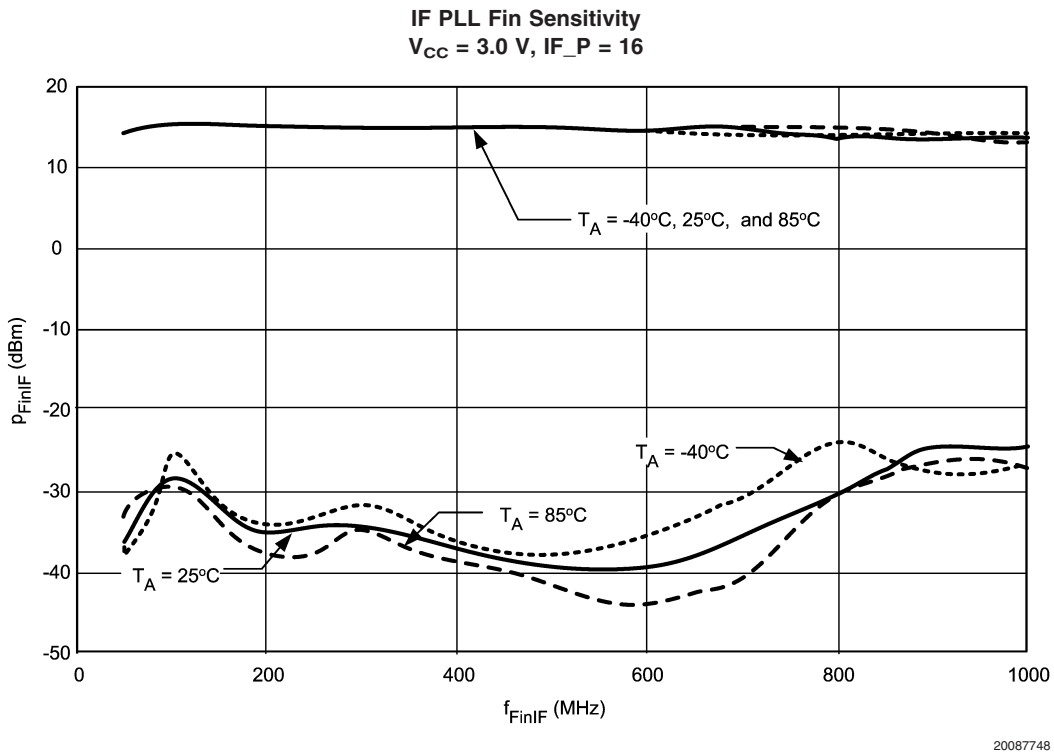
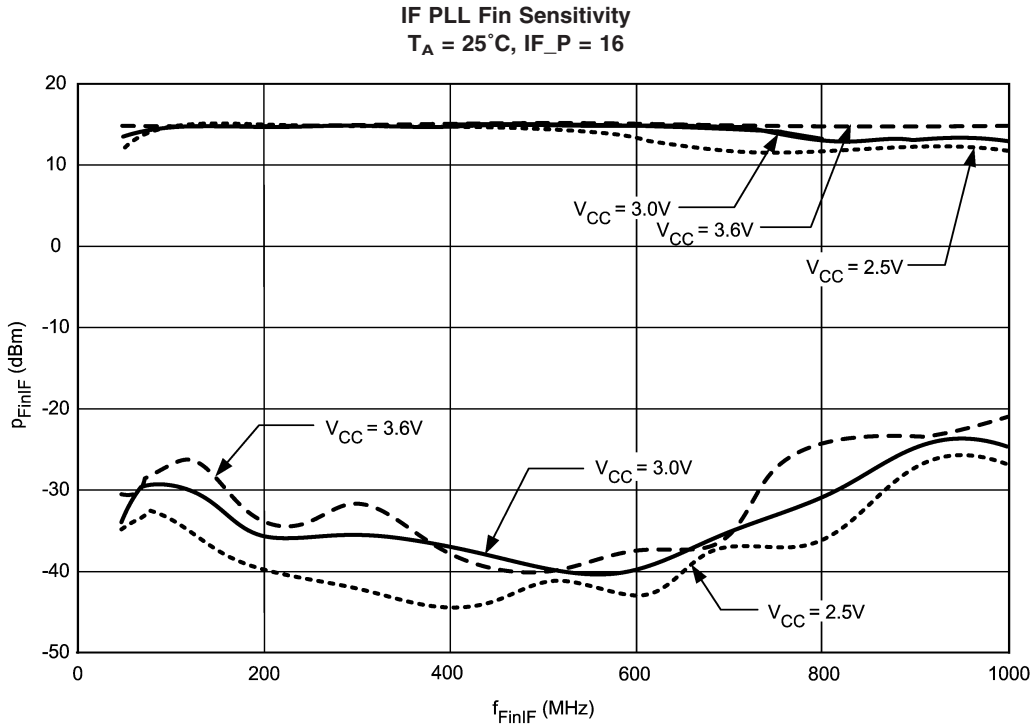

Typical Performance Characteristics : Sensitivity (Note 8) (Continued)

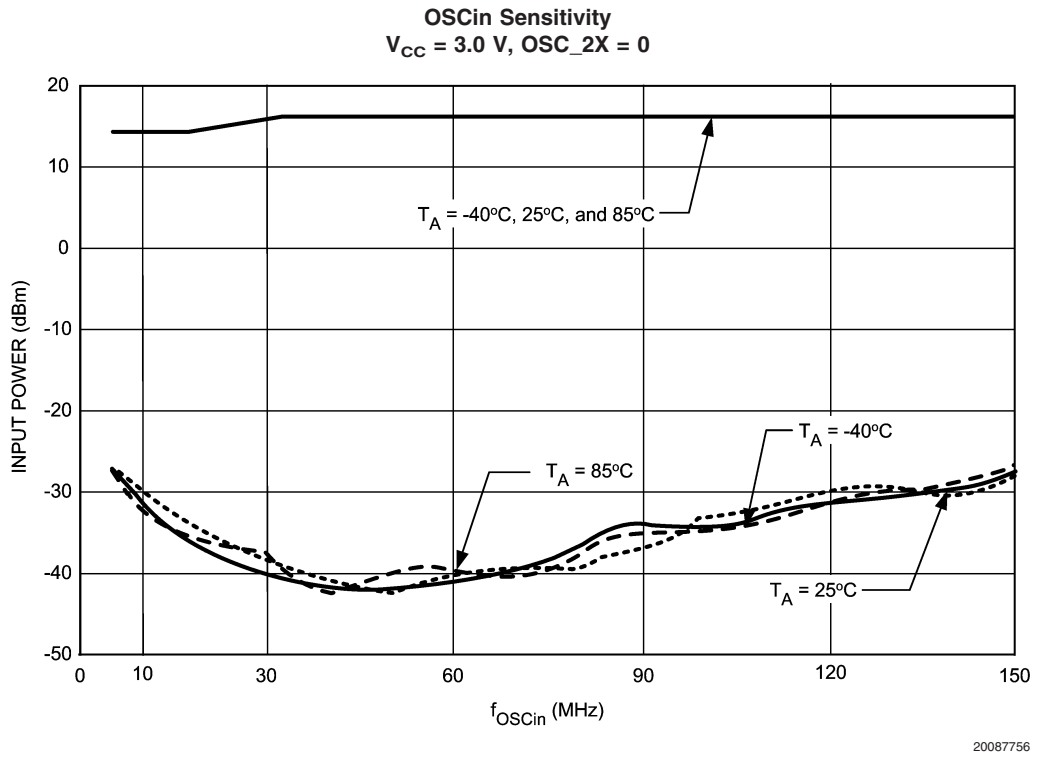
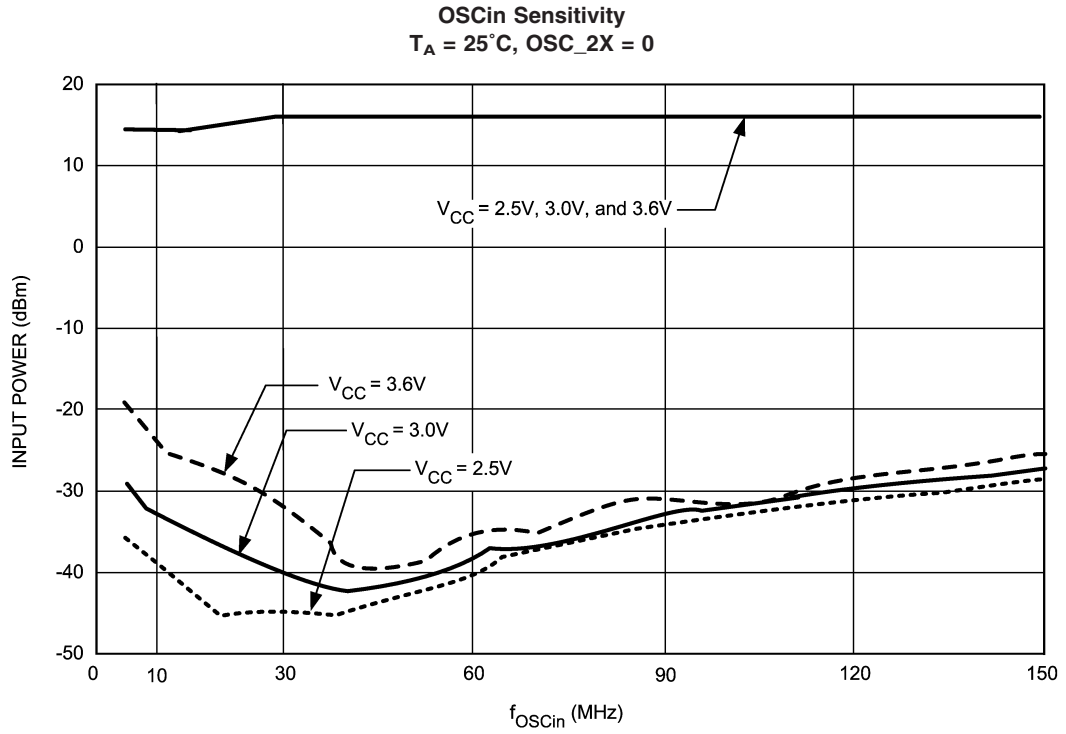

Typical Performance Characteristics : Sensitivity (Note 8) (Continued)

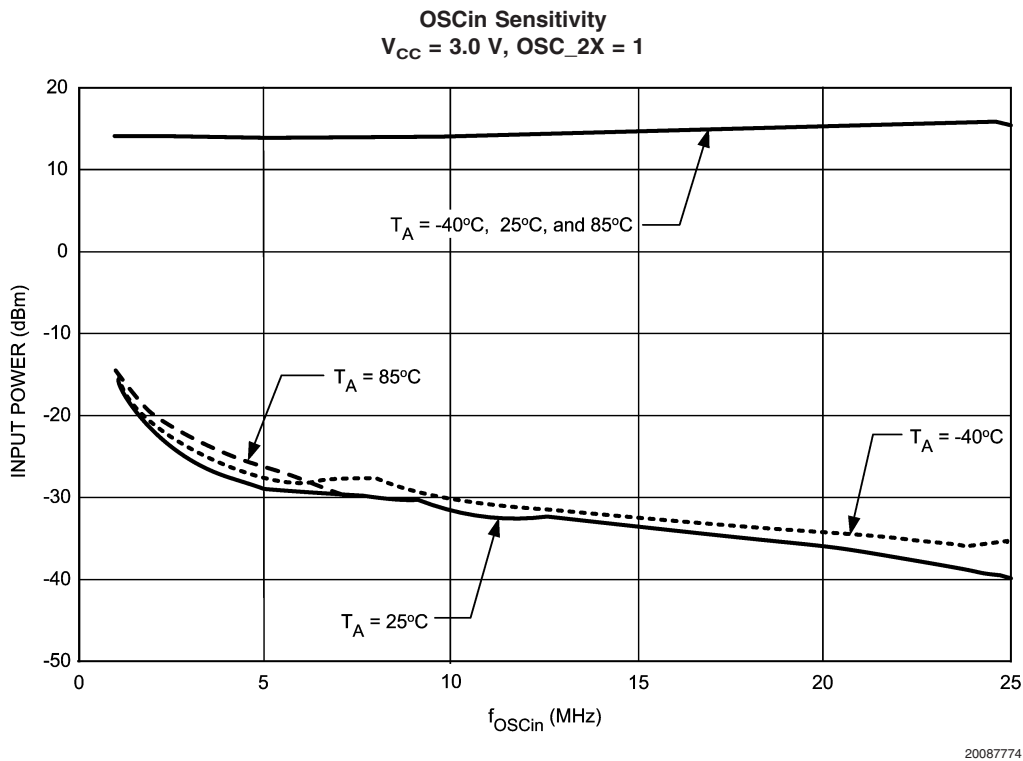
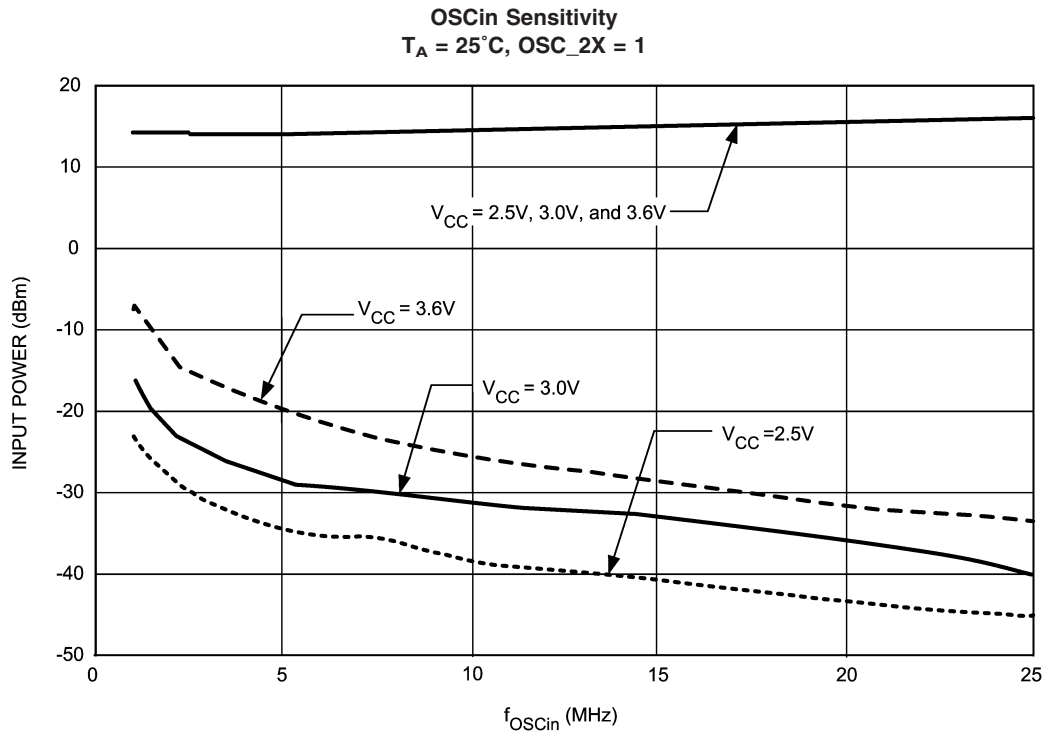

Typical Performance Characteristic : FinRF Input Impedance (Note 8)

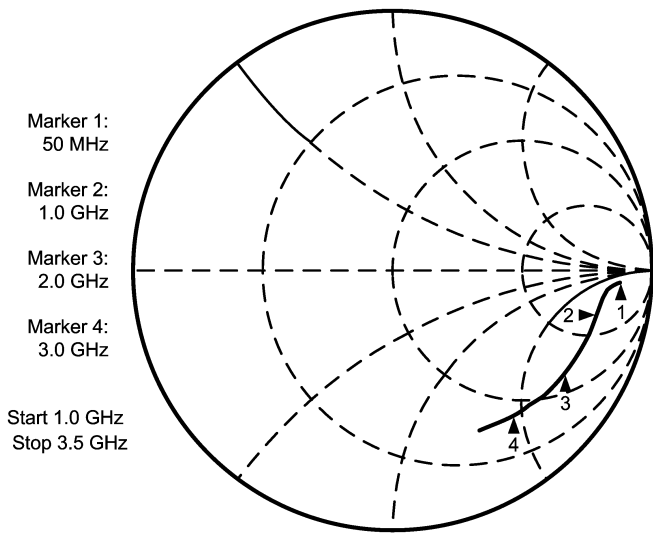

20087768

FinRF Input Impedance		
Frequency (MHz)	Real (Ohms)	Imaginary (Ohms)
50	670	-276
100	531	-247
200	452	-209
300	408	-212
400	373	-222
500	337	-231
600	302	-237
700	270	-239
800	241	-236
900	215	-231
1000	192	-221
1100	172	-218
1200	154	-209
1300	139	-200
1400	127	-192
1500	114	-184
1600	104	-175
1700	96	-168
1800	88	-160
1900	80	-153
2000	74	-147
2200	64	-134
2400	56	-123
2600	50	-113
2800	45	-103
3000	39	-94
3200	37	-86
3400	33	-78
3600	30	-72
3800	28	-69
4000	26	-66

Typical Performance Characteristic : FinIF Input Impedance (Note 8)

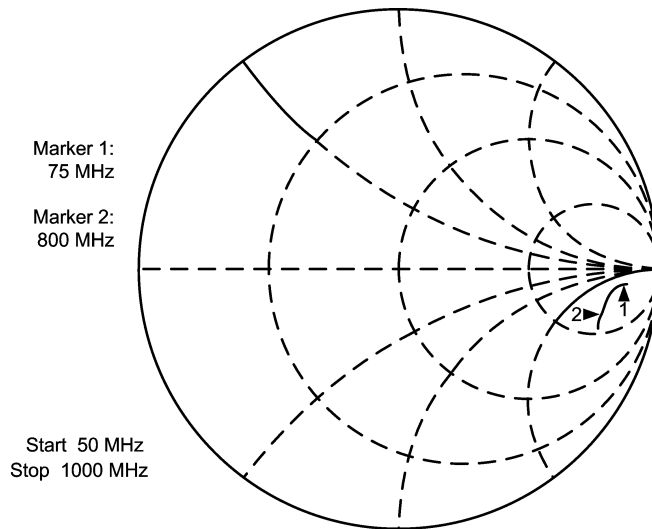

20087754

FinIF Input Impedance		
Frequency (MHz)	Real (Ohms)	Imaginary (Ohms)
50	583	-286
75	530	-256
100	499	-241
200	426	-209
300	384	-209
400	347	-219
500	310	-224
600	276	-228
700	244	-228
800	216	-223
900	192	-218
1000	173	-208

Typical Performance Characteristic : OSCin Input Impedance (Note 8)

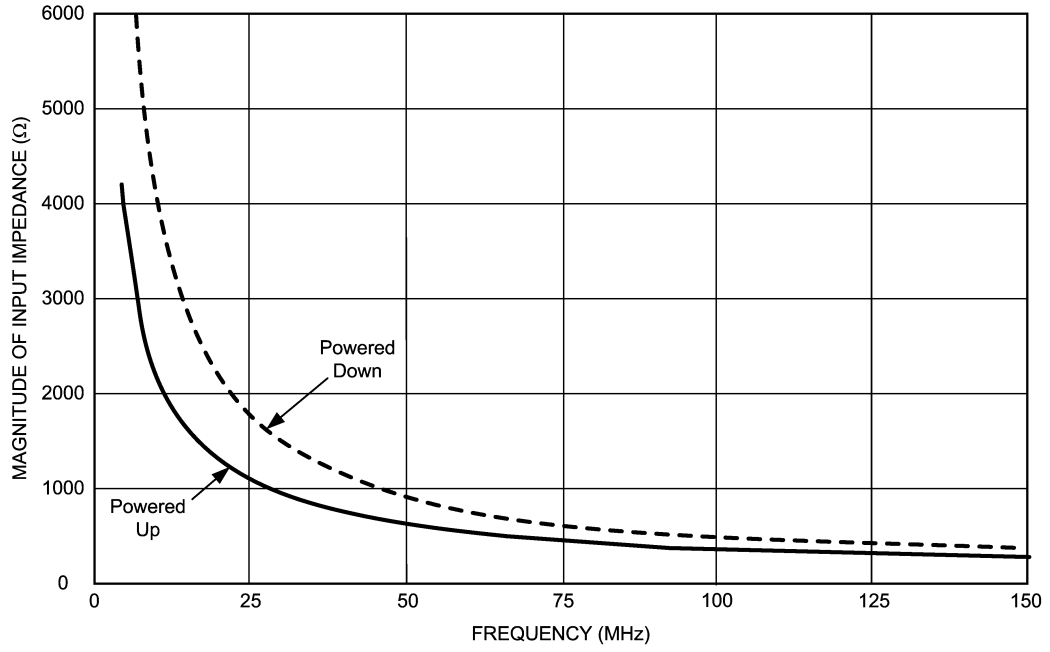

20087755

Frequency (MHz)	Powered Up			Powered Down		
	Real	Imaginary	Magnitude	Real	Imaginary	Magnitude
5	1730	-3779	4157	392	-8137	8146
10	846	-2236	2391	155	-4487	4490
20	466	-1196	1284	107	-2215	2217
30	351	-863	932	166	-1495	1504
40	316	-672	742	182	-1144	1158
50	278	-566	631	155	-912	925
60	261	-481	547	153	-758	774
70	252	-425	494	154	-652	669
80	239	-388	456	147	-576	595
90	234	-358	428	145	-518	538
100	230	-337	407	140	-471	492
110	225	-321	392	138	-436	458
120	219	-309	379	133	-402	423
130	214	-295	364	133	-374	397
140	208	-285	353	132	-349	373
150	207	-279	348	133	-329	355

Typical Performance Characteristics : Currents (Note 8)

Power Supply Current
CE = High

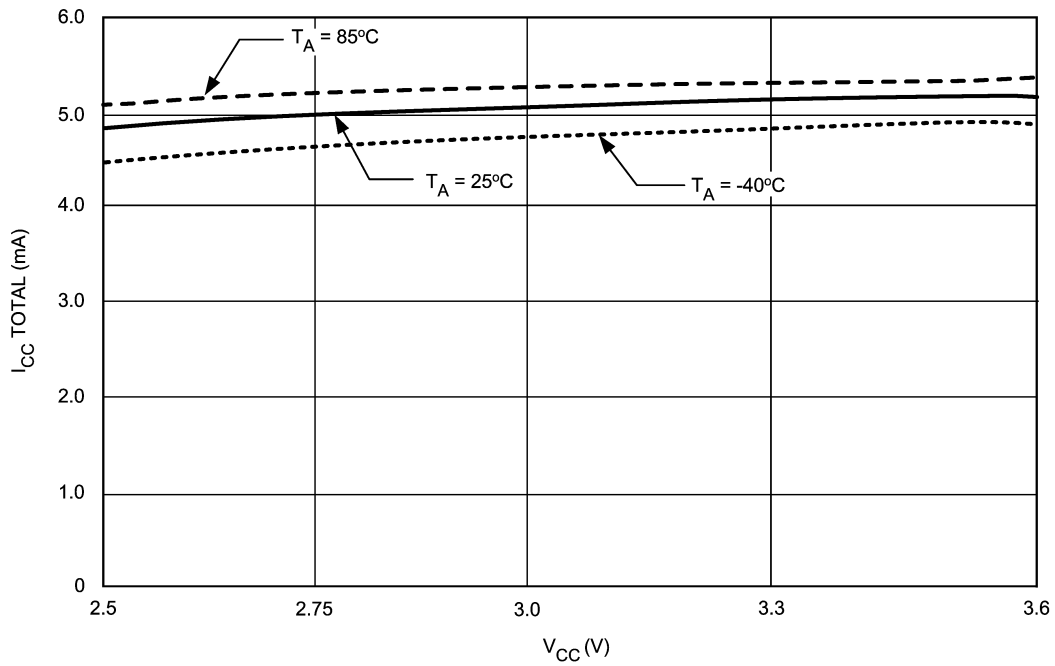

20087759

Power Supply Current
CE = LOW

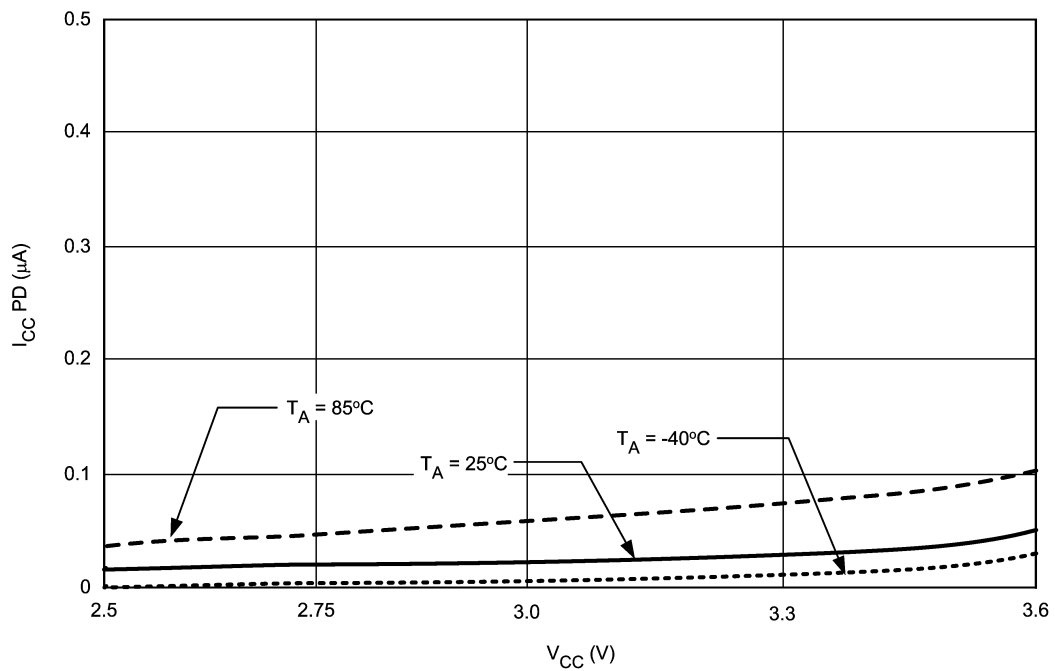

20087761

Typical Performance Characteristics : Currents (Note 8) (Continued)

RF PLL Charge Pump Current
 $V_{CC} = 3.0$ Volts

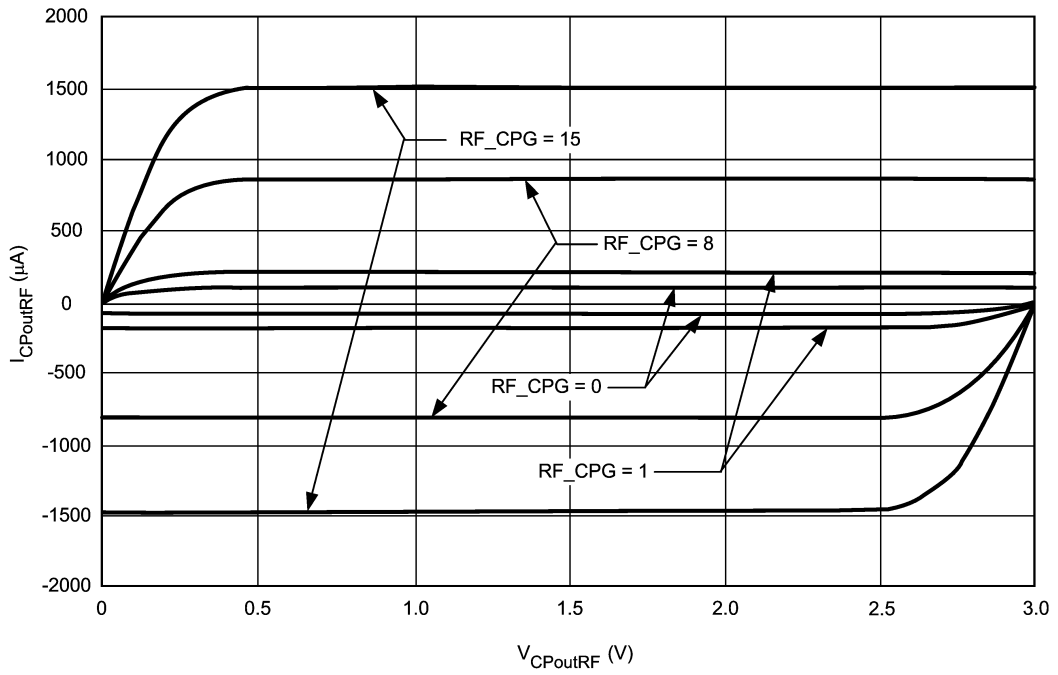

20087767

IF PLL Charge Pump Current
 $V_{CC} = 3.0$ Volts

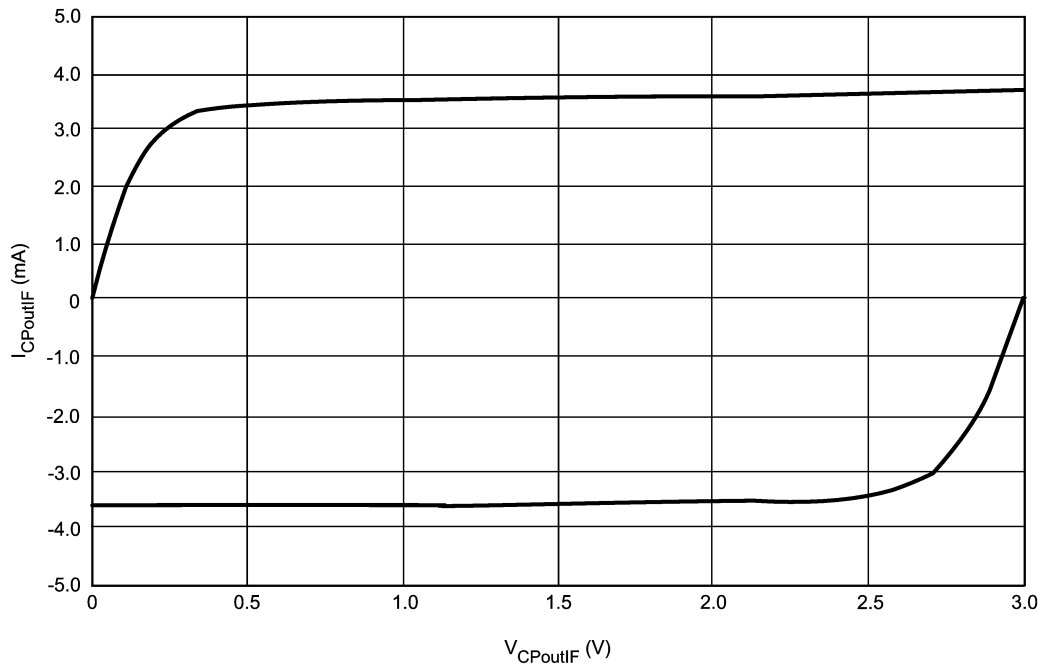

20087765

Typical Performance Characteristics : Currents (Note 8) (Continued)

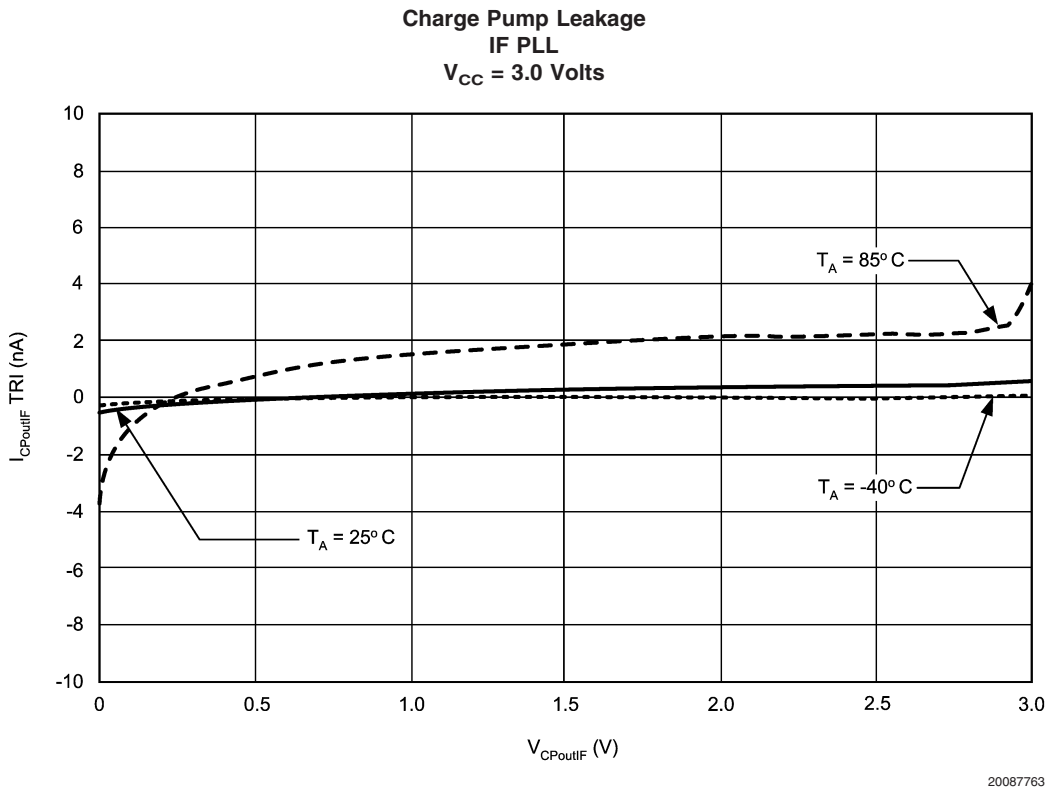
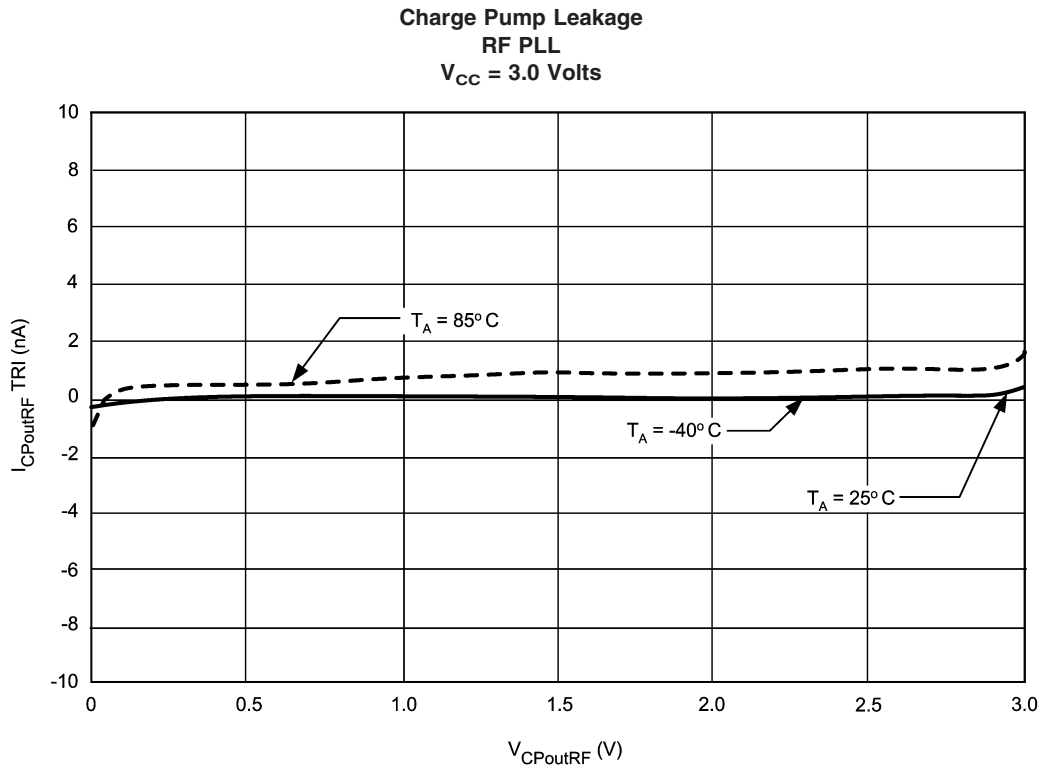

Note 8: Typical performance characteristics do not imply any sort of guarantee. Guaranteed specifications are in the electrical characteristics section.

Bench Test Setups

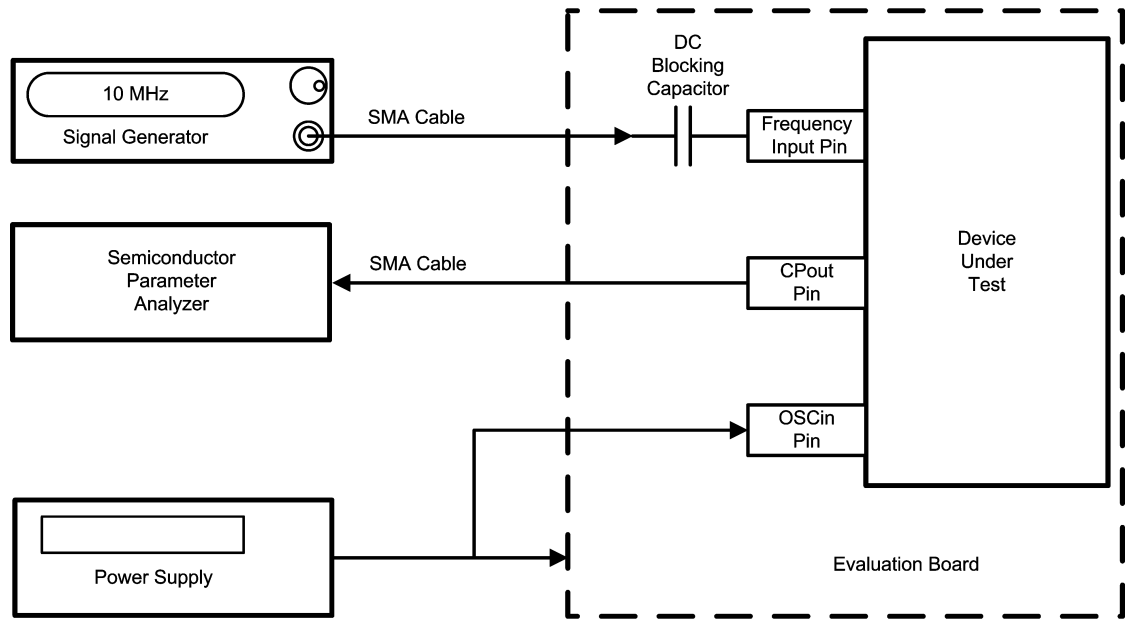

Charge Pump Current Measurement Procedure

The above block diagram shows the test procedure for testing the RF and IF charge pumps. These tests include absolute current level, mismatch, and leakage measurement. In order to measure the charge pump currents, a signal is applied to the high frequency input pins. The reason for this is to guarantee that the phase detector gets enough transitions in order to be able to change states. If no signal is applied, it is possible that the charge pump current reading will be low due to the fact that the duty cycle is not 100%. The OSCin Pin is tied to the supply. The charge pump currents can be measured by simply programming the phase detector to the necessary polarity. For instance, in order to measure the RF charge pump, a 10 MHz signal is applied to the FinRF pin. The source current can be measured by setting the RF PLL phase detector to a positive polarity, and the sink current can be measured by setting the phase detector to a negative polarity. The IF PLL currents can be measured in a similar way. Note that the magnitude of the RF PLL charge pump current is controlled by the RF_CPG bit. Once the charge pump currents are known, the mismatch can be calculated as well. In order to measure leakage, the charge pump is set to a TRI-STATE mode by enabling the RF_CPT and IF_CPT bits. The table below shows a summary of the various charge pump tests.

Current Test	RF_CPG	RF_CPP	RF_CPT	IF_CPP	IF_CPT
RF Source	0 to 15	0	0	X	X
RF Sink	0 to 15	1	0	X	X
RF TRI-STATE	X	X	1	X	X
IF Source	X	X	X	0	0
IF Sink	X	X	X	1	0
IF TRI-STATE	X	X	X	X	1

Bench Test Setups (Continued)

Charge Pump Current Specification Definitions

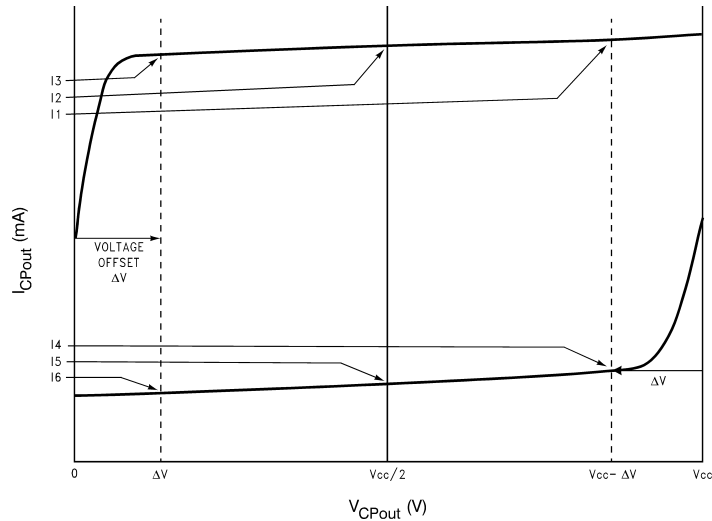

I1 = Charge Pump Sink Current at $V_{CPout} = V_{CC} - \Delta V$

I2 = Charge Pump Sink Current at $V_{CPout} = V_{CC}/2$

I3 = Charge Pump Sink Current at $V_{CPout} = \Delta V$

I4 = Charge Pump Source Current at $V_{CPout} = V_{CC} - \Delta V$

I5 = Charge Pump Source Current at $V_{CPout} = V_{CC}/2$

I6 = Charge Pump Source Current at $V_{CPout} = \Delta V$

ΔV = Voltage offset from the positive and negative supply rails. Defined to be 0.5 volts for this part.

V_{CPout} refers to either $V_{CPoutRF}$ or $V_{CPoutIF}$

I_{CPout} refers to either $I_{CPoutRF}$ or $I_{CPoutIF}$

Charge Pump Output Current Magnitude Variation vs. Charge Pump Output Voltage

$$I_{CPout} \text{ Vs } V_{CPout} = \frac{(|I1| - |I3|)}{(|I1| + |I3|)} \times 100\%$$

$$= \frac{(|I4| - |I6|)}{(|I4| + |I6|)} \times 100\%$$

20087751

Charge Pump Sink Current vs. Charge Pump Output Source Current Mismatch

$$I_{CPout} \text{ Sink Vs } I_{CPout} \text{ Source} = \frac{|I2| - |I5|}{\frac{1}{2}(|I2| + |I5|)} \times 100\%$$

20087752

Charge Pump Output Current Magnitude Variation vs. Temperature

$$I_{CPout} \text{ Vs } T_A = \frac{|I2|_{T_A=25^\circ C} - |I2|_{T_A=25^\circ C}}{|I2|_{T_A=25^\circ C}} \times 100\%$$

$$= \frac{|I5|_{T_A=25^\circ C} - |I5|_{T_A=25^\circ C}}{|I5|_{T_A=25^\circ C}} \times 100\%$$

20087753

Bench Test Setups (Continued)

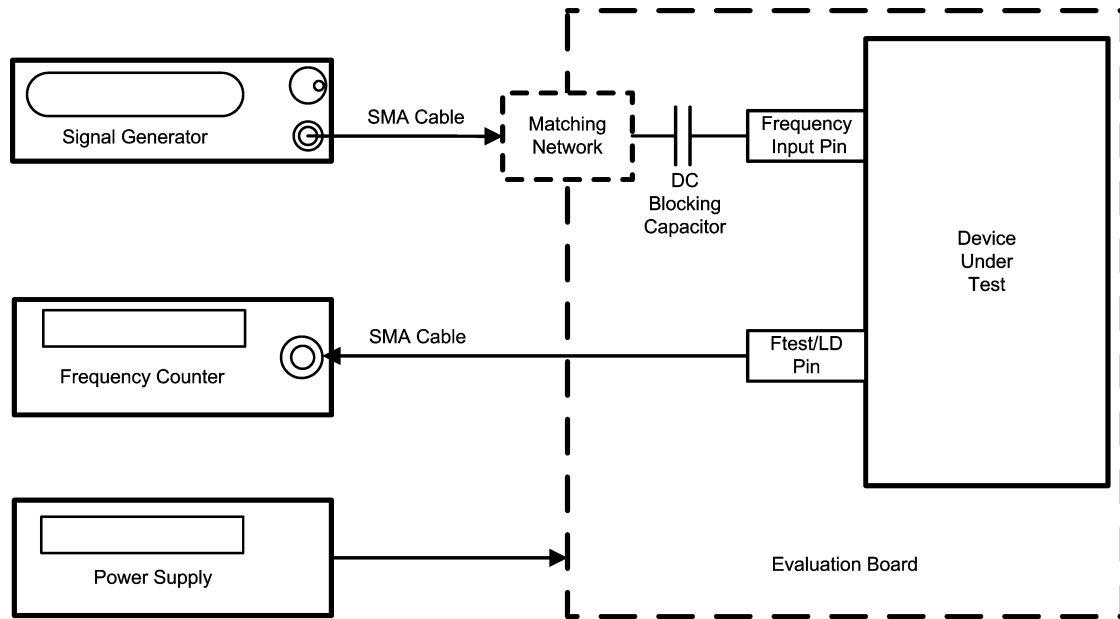

20087770

Frequency Input Pin	DC Blocking Capacitor	Corresponding Counter	Default Counter Value	MUX Value
OSCin	1000 pF	RF_R / 2	50	14
FinRF	100 pF// 1000 pF	RF_N / 2	502 + 2097150 / 4194301	15
FinIF	100 pF	IF_N / 2	534	13
OSCin	1000 pF	IF_R / 2	50	12

Sensitivity Measurement Procedure

Sensitivity is defined as the power level limits beyond which the output of the counter being tested is off by 1 Hz or more of its expected value. It is typically measured over frequency, voltage, and temperature. In order to test sensitivity, the MUX[3:0] word is programmed to the appropriate value. The counter value is then programmed to a fixed value and a frequency counter is set to monitor the frequency of this pin. The expected frequency at the Ftest/LD pin should be the signal generator frequency divided by twice the corresponding counter value. The factor of two comes in because the LMX2485 has a flip-flop which divides this frequency by two to make the duty cycle 50% in order to make it easier to read with the frequency counter. The frequency counter input impedance should be set to high impedance. In order to perform the measurement, the temperature, frequency, and voltage is set to a fixed value and the power level of the signal is varied. Note that the power level at the part is assumed to be 4 dB less than the signal generator power level. This accounts for 1 dB for cable losses and 3 dB for the pad. The power level range where the frequency is correct at the Ftest/LD pin to within 1 Hz accuracy is recorded for the sensitivity limits. The temperature, frequency, and voltage can be varied in order to produce a family of sensitivity curves. Since this is an open-loop test, the charge pump is set to TRI-STATE and the unused side of the PLL (RF or IF) is powered down when not being tested. For this part, there are actually four frequency input pins, although there is only one frequency test pin (Ftest/LD). The conditions specific to each pin are shown in above table.

Note that for the RF N counter, a fourth order fractional modulator is used in 22-bit mode with a fraction of 2097150 / 4194301 is used. The reason for this long fraction is to test the RF N counter and supporting fractional circuitry as completely as possible.

Bench Test Setups (Continued)

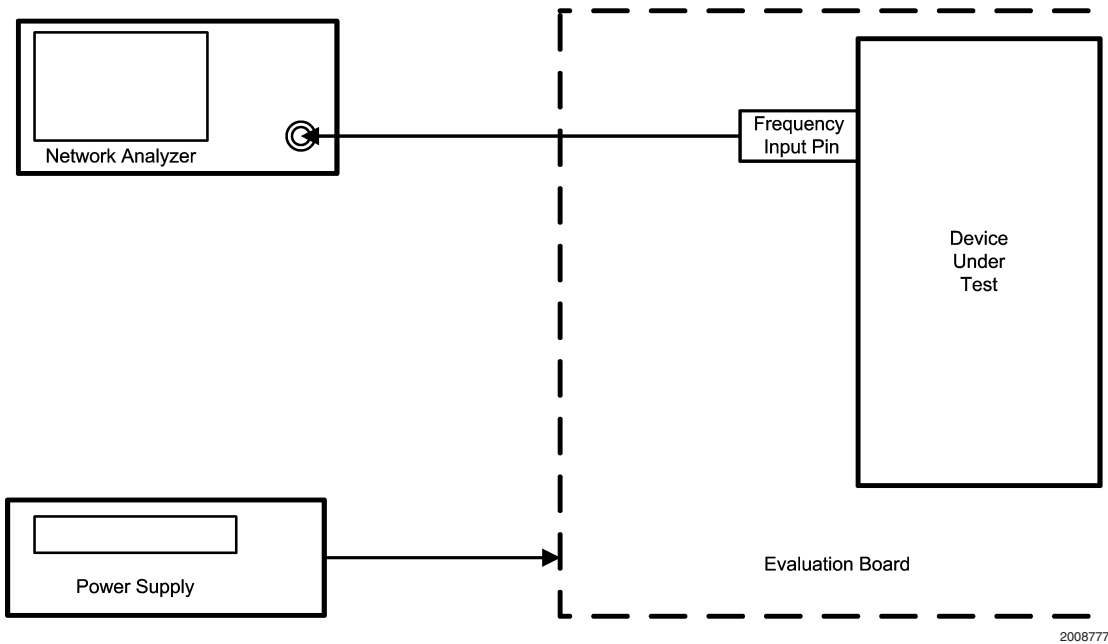

Input Impedance Measurement Procedure

The above block diagram shows the test setup used for measuring the input impedance for the LMX2485. The DC blocking capacitor used between the input SMA connector and the pin being measured must be changed to a zero Ohm resistor. This procedure applies to the FinRF, FinIF, and OSCin pins. The basic test procedure is to calibrate the network analyzer, ensure that the part is powered up, and then measure the input impedance. The network analyzer can be calibrated by using either calibration standards or by soldering resistors directly to the evaluation board. An open can be implemented by putting no resistor, a short can be implemented by soldering a zero ohm resistor as close as possible to the pin being measured, and a short can be implemented by soldering two 100 ohm resistors in parallel as close as possible to the pin being measured. Calibration is done with the PLL removed from the PCB. This requires the use of a clamp down fixture that may not always be generally available. If no clamp down fixture is available, then this procedure can be done by calibrating up to the point where the DC blocking capacitor usually is, and then implementing port extensions with the network analyzer. Zero ohm resistor is added back for the actual measurement. Once the setup is calibrated, it is necessary to ensure that the PLL is powered up. This can be done by toggling the power down bits (RF_PD and IF_PD) and observing that the current consumption indeed increases when the bit is disabled. Sometimes it may be necessary to apply a signal to the OSCin pin in order to program the part. If this is necessary, disconnect the signal once it is established that the part is powered up. It is useful to know the input impedance of the PLL for the purposes of debugging RF problems and designing matching networks. Another use of knowing this parameter is make the trace width on the PCB such that the input impedance of this trace matches the real part of the input impedance of the PLL frequency of operation. In general, it is good practice to keep trace lengths short and make designs that are relatively resistant to variations in the input impedance of the PLL.

Functional Description (Note 9)

1.0 GENERAL

The LMX2485 consists of integrated N counters, R counters, and charge pumps. The TCXO, VCO and loop filter are supplied external to the chip. The various blocks are described below.

1.1 TCXO, OSCILLATOR BUFFER, AND R COUNTER

The oscillator buffer must be driven single-ended by a signal source, such as a TCXO. The OSCout pin is included to provide a buffered output of this input signal and is active when the OSC_OUT bit is set to one. The ENOSC pin can be also pulled high to ensure that the OSCout pin is active, regardless of the status of the registers in the LMX2485.

The R counter divides this TXCO frequency down to the comparison frequency.

1.2 PHASE DETECTOR

The maximum phase detector operating frequency for the IF PLL is straightforward, but it is a little more involved for the RF PLL since it is fractional. The maximum phase detector frequency for the LMX2485 RF PLL is 50 MHz. However, this is not possible in all circumstances due to illegal divide ratios of the N counter. The crystal reference frequency also limits the phase detector frequency, although the doubler helps with this limitation. There are trade-offs in choosing the phase detector frequency. If this frequency is run higher, then phase noise will be lower, but lock time may be increased due to cycle slipping and the capacitors in the loop filter may become rather large.

1.3 CHARGE PUMP

For the majority of the time, the charge pump output is high impedance, and the only current through this pin is the Tri-State leakage. However, it does put out fast correction pulses that have a width that is proportional to the phase error presented at the phase detector.

The charge pump converts the phase error presented at the phase detector into a correction current. The magnitude of this current is theoretically constant, but the duty cycle is proportional to the phase error. For the IF PLL, this current is not programmable, but for the RF PLL it is programmable in 16 steps. Also, the RF PLL allows for a higher charge pump current to be used when the PLL is locking in order to reduce the lock time.

1.4 LOOP FILTER

The loop filter design can be rather involved. In addition to the regular constraints and design parameters, delta-sigma PLLs have the additional constraint that the order of the loop filter should be one greater than the order of the delta sigma modulator. This rule of thumb comes from the requirement that the loop filter must roll off the delta sigma noise at 20 dB/decade faster than it rises. However, since the noise can not have infinite power, it must eventually roll off. If the loop bandwidth is narrow, this requirement may not be necessary. For the purposes of discussion in this datasheet, the pole of the loop filter at 0 Hz is not counted. So a second order filter has 3 components, a 3rd order loop filter has 5 components, and the 4th order loop filter has 7 components. Although a 5th order loop filter is theoretically necessary for use with a 4th order modulator, typically a 4th order filter is used in this case. The loop filter design, especially for higher orders can

be rather involved, but there are many simulation tools and references available, such as the one given at the end of the functional description block.

1.5 N COUNTERS AND HIGH FREQUENCY INPUT PINS

The N counter divides the VCO frequency down to the comparison frequency. Because prescalers are used, there are limitations on how small the N value can be. The N counters are discussed in greater depth in the programming section. Since the input pins to these counters (FinRF and FinLF) are high frequency, layout considerations are important.

High Frequency Input Pins, FinRF and FinLF

It is generally recommended that the VCO output go through a resistive pad and then through a DC blocking capacitor before it gets to these high frequency input pins. If the trace length is sufficiently short (< 1/10th of a wavelength), then the pad may not be necessary, but a series resistor of about 39 ohms is still recommended to isolate the PLL from the VCO. The DC blocking capacitor should be chosen at least to be 27 pF, depending on frequency. It may turn out that the frequency is above the self-resonant frequency of the capacitor, but since the input impedance of the PLL tends to be capacitive, it actually is a benefit to exceed the tune frequency. The pad and the DC blocking capacitor should be placed as close to the PLL as possible

Complementary High Frequency Pin, FinRF*

These inputs may be used to drive the PLL differentially, but it is very common to drive the PLL in a single ended fashion. A shunt capacitor should be placed at the FinRF* pin. The value of this capacitor should be chosen such that the impedance, including the ESR of the capacitor, is as close to an AC short as possible at the operating frequency of the PLL. 100 pF is a typical value, depending on frequency.

1.6 POWER PINS, POWER DOWN, AND POWER UP MODES

It is recommended that all of the power pins be filtered with a series 18 ohm resistor and then placing two capacitors shunt to ground, thus creating a low pass filter. Although it makes sense to use large capacitor values in theory, the ESR (Equivalent Series Resistance) is greater for larger capacitors. For optimal filtering minimize the sum of the ESR and theoretical impedance of the capacitor. It is therefore recommended to provide two capacitors of very different sizes for the best filtering. 1 μ F and 100 pF are typical values. The small capacitor should be placed as close as possible to the pin.

The power down state of the LMX2485 is controlled by many factors. The one factor that overrides all other factors is the CE pin. If this pin is low, the part will be powered down. Asserting a high logic level on this pin is necessary to power up the chip, however, there are other bits in the programming registers that can override this and put the PLL back in a power down state. Provided that the voltage on the CE pin is high, programming the RF_PD and IF_PD bits to zero guarantees that the part will be powered up. Programming either one of these bits to one will power down the appropriate section of the synthesizer, provided that the ATPU bit does not override this.

Functional Description (Note 9)

(Continued)

CE Pin	RF_PD	ATPU Bit Enabled + Write to RF N Counter	PLL State
Low	X	X	Powered Down (Asynchronous)
High	X	Yes	Powered Up
High	0	No	Powered Up
High	1	No	Powered Down (Asynchronous)

1.7 DIGITAL LOCK DETECT OPERATION

The RF PLL digital lock detect circuitry compares the difference between the phase of the inputs of the phase detector to a RC generated delay of ϵ . To indicate a locked state (Lock = HIGH) the phase error must be less than the ϵ RC delay for 5 consecutive reference cycles. Once in lock (Lock = HIGH), the RC delay is changed to approximately δ . To indicate an out of lock state (Lock = LOW), the phase error must become greater δ . The values of ϵ and δ are dependent on which PLL is used and are shown in the table below:

PLL	ϵ	δ
RF	10 ns	20 ns
IF	15 ns	30 ns

When the PLL is in the power down mode and the Ftest/LD pin is programmed for the lock detect function, it is forced LOW. The accuracy of this circuit degrades at higher comparison frequencies. To compensate for this, the DIV4 word should be set to one if the comparison frequency exceeds 20 MHz. The function of this word is to divide the comparison frequency presented to the lock detect circuit by 4. Note that if the MUX[3:0] word is set such as to view lock detect for both PLLs, an unlocked (LOW) condition is shown whenever either one of the PLLs is determined to be out of lock.

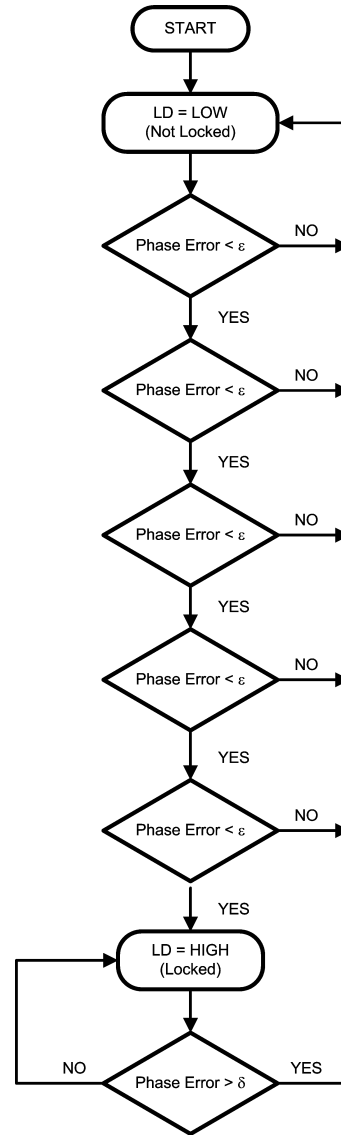

20087704

Functional Description (Note 9)

(Continued)

1.8 CYCLE SLIP REDUCTION AND FASTLOCK

The LMX2485 offers both cycle slip reduction (CSR) and Fastlock with timeout counter support. This means that it requires no additional programming overhead to use them. It is generally recommended that the charge pump current in the steady state be 8X or less in order to use cycle slip reduction, and 4X or less in steady state in order to use Fastlock. The next step is to decide between using Fastlock or CSR. This determination can be made based on the ratio of the comparison frequency (f_{COMP}) to loop bandwidth (BW).

Comparison Frequency (f_{COMP})	Fastlock	Cycle Slip Reduction (CSR)
$f_{COMP} \leq 1.25$ MHz	Noticeable better than CSR	Likely to provide a benefit, provided that $f_{COMP} > 100 \times$ BW
1.25 MHz < $f_{COMP} \leq 2$ MHz	Marginally better than CSR	
$f_{COMP} > 2$ MHz	Same or worse than CSR	

Cycle Slip Reduction (CSR)

Cycle slip reduction works by reducing the comparison frequency during frequency acquisition while keeping the same loop bandwidth, thereby reducing the ratio of the comparison frequency to the loop bandwidth. In cases where the ratio of the comparison frequency exceeds about 100 times the loop bandwidth, cycle slipping can occur and significantly degrade lock times. The greater this ratio, the greater the benefit of CSR. This is typically the case of high comparison frequencies. In circumstances where there is not a problem with cycle slipping, CSR provides no benefit. There is a glitch when CSR is disengaged, but since CSR should be disengaged long before the PLL is actually in lock, this glitch is not an issue. A good rule of thumb for CSR disengagement is to do this at the peak time of the transient response. Because this time is typically much sooner than Fastlock should be disengaged, it does not make sense to use CSR and Fastlock in combination.

Fastlock

Fastlock works by increasing the loop bandwidth only during frequency acquisition. In circumstances where the comparison frequency is less than or equal to 2 MHz, Fastlock may provide a benefit beyond what CSR can offer. Since Fastlock also reduces the ratio of the comparison frequency to the loop bandwidth, it may provide a significant benefit in cases where the comparison frequency is above 2 MHz. However, CSR can usually provide an equal or larger benefit in these cases, and can be implemented without using an additional resistor. The reason for this restriction on frequency is that Fastlock has a glitch when it is disengaged. As the time of engagement for Fastlock decreases and becomes on the order of the fast lock time, this glitch grows and limits the benefits of Fastlock. This effect becomes worse at higher comparison frequencies. There is always the option of reducing the comparison frequency at the expense of phase noise in order to satisfy this constraint on comparison frequency. Despite this glitch, there is still a net improvement in lock time using Fastlock in these circumstances. When using Fastlock, it is also recommended that the steady state charge pump state be 4X or less. Also, Fastlock was origi-

nally intended only for second order filters, so when implementing it with higher order filters, the third and fourth poles can not be too close in, or it will not be possible to keep the loop filter well optimized when the higher charge pump current and Fastlock resistor are engaged.

1.8.1 Using Cycle Slip Reduction (CSR) to Avoid Cycle Slipping

Once it is decided that CSR is to be used, the cycle slip reduction factor needs to be chosen. The available factors are 1/2, 1/4, and 1/16. In order to preserve the same loop characteristics, it is recommended that the following constraint be satisfied: **(Fastlock Charge Pump Current) / (Steady State Charge Pump Current) = CSR**

In order to satisfy this constraint, the maximum charge pump current in steady state is 8X for a CSR of 1/2, 4X for a CSR of 1/4, and 1X for a CSR of 1/16. Because the PLL phase noise is better for higher charge pump currents, it makes sense to choose CSR only as large as necessary to prevent cycle slipping. Choosing it larger than this will not improve lock time, and will result in worse phase noise.

Consider an example where the desired loop bandwidth in steady state is 100 kHz and the comparison frequency is 20 MHz. This yields a ratio of 200. Cycle slipping may be present, but would not be too severe if it was there. If a CSR factor of 1/2 is used, this would reduce the ratio to 100 during frequency acquisition, which is probably sufficient. A charge pump current of 8X could be used in steady state, and a factor of 16X could be used during frequency acquisition. This yields a ratio of 1/2, which is equal to the CSR factor and this satisfies the above constraint. In this circumstance, it could also be decided to just use 16X charge pump current all the time, since it would probably have better phase noise, and the degradation in lock time would not be too severe.

1.8.2 Using Fastlock to Improve Lock Times

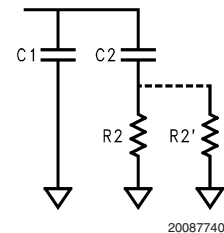

Once it is decided that Fastlock is to be used, the loop bandwidth multiplier, K, is needed in order to determine the theoretical impact of Fastlock on the loop bandwidth and the resistor value, R2p, that is switched in parallel during Fastlock. This ratio is calculated as follows: **$K = (\text{Fastlock Charge Pump Current}) / (\text{Steady State Charge Pump Current})$**

K	Loop Bandwidth	R2p Value	Lock Time
1	1.00 X	Open	100 %
2	1.41 X	R2/0.41	71 %
3	1.73 X	R2/0.73	58%
4	2.00 X	R2	50%
8	2.83 X	R2/1.83	35%
9	3.00 X	R2/2	33%
16	4.00 X	R2/3	25%

The above table shows how to calculate the Fastlock resistor and theoretical lock time improvement, once the ratio , K, is

Functional Description (Note 9)

(Continued)

known. This all assumes a second order filter (not counting the pole at 0 Hz). However, it is generally recommended that the loop filter order be one greater than the order of the delta sigma modulator, which means that a second order filter is never recommended. In this case, the value for R2p is typically about 80% of what it would be for a second order filter. Because the Fastlock disengagement glitch gets larger and it is harder to keep the loop filter optimized as the K value becomes larger, designing for the largest possible value for K usually, but not always yields the best improvement in lock time. To get a more accurate estimate requires more simulation tools, or trial and error.

1.8.3 Capacitor Dielectric Considerations for Lock Time

The LMX2485 has a high fractional modulus and high charge pump gain for the lowest possible phase noise. One consideration is that the reduced N value and higher charge pump may cause the capacitors in the loop filter to become larger in value. For larger capacitor values, it is common to have a trade-off between capacitor dielectric quality and physical size. Using film capacitors or NPO/COG capacitors yields the best possible lock times, where as using X7R or Z5R capacitors can increase lock time by 0 – 500%. However, it is a general tendency that designs that use a higher compare frequency tend to be less sensitive to the effects of capacitor dielectrics. Although the use of lesser quality dielectric capacitors may be unavoidable in many circumstances, allowing a larger footprint for the loop filter capacitors, using a lower charge pump current, and reducing the fractional modulus are all ways to reduce capacitor values. Capacitor dielectrics have very little impact on phase noise and spurs.

1.9 FRACTIONAL SPUR AND PHASE NOISE CONTROLS

Control of the fractional spurs is more of an art than an exact science. The first differentiation that needs to be made is between primary fractional and sub-fractional spurs. The primary fractional spurs are those that occur at increments of the channel spacing only. The sub-fractional spurs are those that occur at a smaller resolution than the channel spacing,

usually one-half or one-fourth. There are trade-offs between fractional spurs, sub-fractional spurs, and phase noise. The rules of thumb presented in this section are just that. There will be exceptions. The bits that impact the fractional spurs are FM and DITH, and these bits should be set in this order.

The first step to do is choose FM, for the delta sigma modulator order. It is recommended to start with FM = 3 for a third order modulator and use strong dithering. In general, there is a trade-off between primary and sub-fractional spurs. Choosing the highest order modulator (FM = 0 for 4th order) typically provides the best primary fractional spurs, but the worst sub-fractional spurs. Choosing the lowest modulator order (FM = 2 for 2nd order), typically gives the worst primary fractional spurs, but the best sub-fractional spurs. Choosing FM = 3, for a 3rd order modulator is a compromise.

The second step is to choose DITH, for dithering. Dithering has a very small impact on primary fractional spurs, but a much larger impact on sub-fractional spurs. The only problem is that it can add a few dB of phase noise, or even more if the loop bandwidth is very wide. Disabling dithering (DITH = 0), provides the best phase noise, but the sub-fractional spurs are worst (except when the fractional numerator is 0, and in this case, they are the best). Choosing strong dithering (DITH = 2) significantly reduces sub-fractional spurs, if not eliminating them completely, but adds the most phase noise. Weak dithering (DITH = 1) is a compromise.

The third step is to tinker with the fractional word. Although 1/10 and 400/4000 are mathematically the same, expressing fractions with much larger fractional numerators often improve the fractional spurs. Increasing the fractional denominator only improves spurs to a point. A good practical limit could be to keep the fractional denominator as large as possible, but not to exceed 4095, so it is not necessary to use the extended fractional numerator or denominator.

This steps can be done in different orders and it might take a few iterations to find the optimum performance. Special considerations should be taken for lower frequencies that are below about 100 MHz. In addition squaring up the wave, it is often helpful to use lowest terms fractions instead of highest terms fractions. Also, dithering may turn out to not be so useful. All the things are to introduce a methodical way of thinking about optimizing spurs, not an exact method. There will be exceptions to all these rules.

Note 9: For more information concerning delta-sigma PLLs, loop filter design, cycle slip reduction, Fastlock, and many other topics, visit wireless.national.com. Here there is the EasyPLL simulation tool and an online reference called "PLL Performance, Simulation, and Design", by Dean Banerjee.

Programming Description

2.0 GENERAL PROGRAMMING INFORMATION

The 24-bit data registers are loaded through a MICROWIRE Interface. These data registers are used to program the R counter, the N counter, and the internal mode control latches. The data format of a typical 24-bit data register is shown below. The control bits CTL [3:0] decode the register address. On the rising edge of LE, data stored in the shift register is loaded into one of the appropriate latches (selected by address bits). Data is shifted in MSB first. Note that it is best to program the N counter last, since doing so initializes the digital lock detector and Fastlock circuitry. Note that initialize means it resets the counters, but it does NOT program values into these registers. The exception is when 22-bit is not being used. In this case, it is not necessary to program the R7 register.

MSB		LSB			
DATA [21:0]		CTL [3:0]			
23	4	3	2	1	0

2.0.1 Register Location Truth Table

The control bits CTL [3:0] decode the internal register address. The table below shows how the control bits are mapped to the target control register.

C3	C2	C1	C0	DATA Location
x	x	x	0	R0
0	0	1	1	R1
0	1	0	1	R2
0	1	1	1	R3
1	0	0	1	R4
1	0	1	1	R5
1	1	0	1	R6
1	1	1	1	R7

2.0.2 Control Register Content Map

Because the LMX2485 registers are complicated, they are organized into two groups, basic and advanced. The first four registers are basic registers that contain critical information necessary for the PLL to achieve lock. The last 5 registers are for features that optimize spur, phase noise, and lock time performance. The next page shows these registers.

Programming Description (Continued)

Quick Start Register Map Although it is highly recommended that the user eventually take advantage of all the modes of the LMX2485, the quick start register map is shown in order for the user to get the part up and running quickly using only those bits critical for basic functionality. The following default conditions for this programming state are a third order delta-sigma modulator in 12-bit mode with no dithering and no Fastlock.

REGISTER	23	22	21	20	19	18	17	16	15	14	13	12	11	10	9	8	7	6	5	4	3	C2	C1	C0		
	DATA[19:0] (Except for the RF_N Register, which is [22:0])																									
R0	RF_FN[11:0]																									
R1	RF_PD	RF_P	RF_FD[11:0]																			0	0	1	1	
R2	IF_PD	IF_N[18:0]																			0	1	0	1		
R3	0001		RF_CPG[3:0]			IF_R[11:0]																	0	1	1	1
R4	0	0	1	0	0	0	0	1	1	0	0	0	1	1	0	0	0	0	0	1	0	0	1			

Complete Register Map

The complete register map shows all the functionality of all registers, including the last five.

REGISTER	23	22	21	20	19	18	17	16	15	14	13	12	11	10	9	8	7	6	5	4	C3	C2	C1	C0		
	DATA[19:0] (Except for the RF_N Register, which is [22:0])																									
R0	RF_FN[11:0]																									
R1	RF_PD	RF_P	RF_FD[11:0]																			0	0	1	1	
R2	IF_PD	IF_N[18:0]																			0	1	0	1		
R3	ACCESS[3:0]		RF_CPG[3:0]			IF_R[11:0]																	0	1	1	1
R4	ATPU	0	1	0	0	0	DITH [1:0]	FM [1:0]	0	OSC _2X _OUT	OSC CPP	IF_ CPP	IF_ CPP	IF_P	MUX [3:0]							1	0	0	1	
R5	RF_FD[21:12]		RF_FN[21:12]																			1	0	1	1	
R6	CSR[1:0]	RF_CPF[3:0]			RF_TOC[13:0]																	1	1	0	1	
R7	0	0	0	0	0	0	0	0	0	DIV4	0	1	0	0	1	IF_RST	RF_RST	IF_CPT	RF_CPT	1	1	1	1			

Programming Description (Continued)

2.1 R0 REGISTER

Note that this register has only one control bit, so the N counter value to be changed with a single write statement to the PLL.

REGISTER	23	22	21	20	19	18	17	16	15	14	13	12	11	10	9	8	7	6	5	4	3	2	1	0
	DATA[22:0]																							C0
R0	RF_N[10:0]											RF_FN[11:0]											0	

2.1.1 RF_FN[11:0] -- Fractional Numerator for RF PLL

Refer to section 2.6.1 for a more detailed description of this control word.

2.1.2 RF_N[10:0] -- RF N Counter Value

The RF N counter contains an 8/9/12/13 and a 16/17/20/21 prescaler. The N counter value can be calculated as follows:

$$N = RF_P \cdot RF_C + 4 \cdot RF_B + RF_A$$

$RF_C \geq \text{Max}\{RF_A, RF_B\}$, for $N-2^{FM}-1 \dots N+2^{FM}$ is a necessary condition. This rule is slightly modified in the case where the RF_B counter has an unused bit, where this extra bit is used by the delta-sigma modulator for the purposes of modulation. Consult the tables below for valid operating ranges for each prescaler.

Operation with the 8/9/12/13 Prescaler (RF_P=0)

RF_N	RF_N [10:0]											
	RF_C [6:0]						RF_B [1:0]		RF_A [1:0]			
<25	N values less than 25 are prohibited.											
25-26	Possible only with a second order delta-sigma engine.											
27-30	Possible only with a second or third order delta-sigma engine.											
31	0	0	0	0	0	0	1	1	0	1	1	1
...	0	.	.	.
1023	1	1	1	1	1	1	1	1	0	1	1	1
>1023	N values above 1023 are prohibited.											

Operation with the 16/17/20/21 Prescaler (RF_P=1)

RF_N	RF_N [10:0]											
	RF_C [6:0]						RF_B [1:0]		RF_A [1:0]			
<49	N values less than 49 are prohibited.											
49-50	Possible only with a second order delta-sigma engine.											
51-54	Possible with a second or third order delta-sigma engine.											
55	0	0	0	0	0	0	1	1	0	1	1	1
...
2039	1	1	1	1	1	1	1	1	0	1	1	1
2040-2043	Possible with a second or third order delta-sigma engine.											
2044-2045	Possible only with a second order delta-sigma engine.											
>2045	N values greater than 2045 are prohibited.											

Programming Description (Continued)

2.2 R1 REGISTER

REGISTER	23	22	21	20	19	18	17	16	15	14	13	12	11	10	9	8	7	6	5	4	3	2	1	0
	DATA[19:0]																				C3	C2	C1	C0
R1	RF_PD	RF_P	RF_R[5:0]					RF_FD[11:0]										0	0	1	1			

2.2.1 RF_FD[11:0] -- RF PLL Fractional Denominator

The function of these bits are described in section 2.6.2.

2.2.2 RF_R [5:0] -- RF R Divider Value

The RF R Counter value is determined by this control word. Note that this counter does allow values down to one.

R Value	RF_R[5:0]					
1	0	0	0	0	0	1
...
63	1	1	1	1	1	1

2.2.3 RF_P -- RF Prescaler bit

The prescaler used is determined by this bit.

RF_P	Prescaler	Maximum Frequency
0	8/9/12/13	2000 MHz
1	16/17/20/21	3000 MHz

2.2.4 RF_PD -- RF Power Down Control Bit

When this bit is set to 0, the RF PLL operates normally. When it is set to one, the RF PLL is powered down and the RF Charge pump is set to a TRI-STATE mode. The CE pin and ATPU bit also control power down functions, and will override the RF_PD bit. The order of precedence is as follows. First, if the CE pin is LOW, then the PLL will be powered down. Provided this is not the case, the PLL will be powered up if the ATPU bit says to do so, regardless of the state of the RF_PD bit. After the CE pin and the ATPU bit are considered, then the RF_PD bit then takes control of the power down function for the RF PLL.

Programming Description (Continued)

2.3 R2 REGISTER

REGISTER	23	22	21	20	19	18	17	16	15	14	13	12	11	10	9	8	7	6	5	4	3	2	1	0	
	DATA[19:0]																				C3	C2	C1	C0	
R2	IF_PD	IF_N[18:0]																				0	1	0	1

2.3.1 IF_N[18:0] -- IF N Divider Value

IF_N Counter Programming with the 8/9 Prescaler (IF_P=0)

N Value	IF_N[18:0]																			
	IF_B															IF_A				
≤23	N values less than or equal to 23 are prohibited because IF_B ≥ 3 is required.																			
24-55	Legal divide ratios in this range are: 24-27, 32-36, 40-45, 48-54																			
56	0	0	0	0	0	0	0	0	0	0	0	0	0	1	1	1	0	0	0	0
57	0	0	0	0	0	0	0	0	0	0	0	0	0	1	1	1	0	0	0	1
...
262143	1	1	1	1	1	1	1	1	1	1	1	1	1	1	1	1	0	1	1	1

Operation with the 16/17 Prescaler (IF_P=1)

N Value	IF_N[18:0]																			
	IF_B															IF_A				
≤47	N values less than or equal to 47 are prohibited because IF_B ≥ 3 is required.																			
48-239	Legal divide ratios in this range are: 48-51, 64-68, 80-85, 96-102, 112-119, 128-136, 144-153, 160-170, 176-187, 192-204, 208-221, 224-238																			
240	0	0	0	0	0	0	0	0	0	0	0	0	1	1	1	1	0	0	0	0
241	0	0	0	0	0	0	0	0	0	0	0	0	1	1	1	1	0	0	0	1
...
524287	1	1	1	1	1	1	1	1	1	1	1	1	1	1	1	1	1	1	1	1

2.3.4 IF_PD -- IF Power Down Bit

When this bit is set to 0, the IF PLL operates normally. When it is set to 1, the IF PLL powers down and the output of the IF PLL charge pump is set to a TRI-STATE mode. If the ATPU bit is set and register R0 is written to, the IF_PD will be reset to 0 and the IF PLL will be powered up. If the CE pin is held low, the IF PLL will be powered down, overriding the IF_PD bit.

Programming Description (Continued)

2.4 R3 REGISTER

REGISTER	23	22	21	20	19	18	17	16	15	14	13	12	11	10	9	8	7	6	5	4	3	2	1	0
	DATA[19:0]																				C3	C2	C1	C0
R3	ACCESS[3:0]				RF_CPG[3:0]				IF_R[11:0]												0	1	1	1

2.4.1 IF_R[11:0] -- IF R Divider Value

For the IF R divider, the R value is determined by the IF_R[11:0] bits in the R3 register. The minimum value for IF_R is 3.

R Value	IF_R[11:0]												
3	0	0	0	0	0	0	0	0	0	0	0	1	1
...
4095	1	1	1	1	1	1	1	1	1	1	1	1	1

2.4.2 RF_CPG -- RF PLL Charge Pump Gain

This is used to control the magnitude of the RF PLL charge pump in steady state operation.

RF_CPG	Charge Pump State	Typical RF Charge Pump Current at 3 Volts (µA)
0	1X	95
1	2X	190
2	3X	285
3	4X	380
4	5X	475
5	6X	570
6	7X	665
7	8X	760
8	9X	855
9	10X	950
10	11X	1045
11	12X	1140
12	13X	1235
13	14X	1330
14	15X	1425
15	16X	1520

2.4.3 ACCESS -- Register Access word

It is mandatory that the first 5 registers R0-R4 be programmed. The programming of registers R5-R7 is optional. The ACCESS[3:0] bits determine which additional registers need to be programmed. Any one of these registers can be individually programmed. According to the table below, when the state of a register is in default mode, all the bits in that register are forced to a default state and it is not necessary to program this register. When the register is programmable, it needs to be programmed through the MICROWIRE. Using this register access technique, the programming required is reduced up to 37%.

ACCESS Bit	Register Location	Register Controlled
ACCESS[0]	R3[20]	Must be set to 1
ACCESS[1]	R3[21]	R5
ACCESS[2]	R3[22]	R6
ACCESS[3]	R3[23]	R7

The default conditions the registers is shown below:

Register	23	22	21	20	19	18	17	16	15	14	13	12	11	10	9	8	7	6	5	4	3	2	1	0	
	Data[19:0]																				C3	C2	C1	C0	
R4	R4 Must be programmed manually.																								
R5	0	0	0	0	0	0	0	0	0	0	0	0	0	0	0	0	0	0	0	0	0	1	0	1	1
R6	0	0	0	0	0	0	0	0	0	0	0	0	0	0	0	0	0	0	0	0	0	1	1	0	1
R7	0	0	0	0	0	0	0	0	0	0	0	0	1	0	0	1	0	0	0	0	0	1	1	1	1

Programming Description (Continued)

This corresponds to the following bit settings.

Register	Bit Location	Bit Name	Bit Description	Bit Value	Bit State
R4	R4[23]	ATPU	Autopowerup	0	Disabled
	R4[17:16]	DITH	Dithering	2	Strong
	R4[15:14]	FM	Modulation Order	3	3rd Order
	R4[12]	OSC_2X	Oscillator Doubler	0	Disabled
	R4[11]	OSC_OUT	OSCOut Pin Enable	0	Disabled
	R4[10]	IF_CPP	IF Charge Pump Polarity	1	Positive
	R4[9]	RF_CPP	RF Charge Pump Polarity	1	Positive
	R4[8]	IF_P	IF PLL Prescaler	1	16/17
	R4[7:4]	MUX	Ftest/LD Output	0	Disabled
R5	R5[23:14]	RF_FD[21:12]	Extended Fractional Denominator	0	Disabled
	R5[13:4]	RF_FN[21:12]	Extended Fractional Numerator	0	Disabled
R6	R6[23:22]	CSR	Cycle Slip Reduction	0	Disabled
	R6[21:18]	RF_CPF	Fastlock Charge Pump Current	0	Disabled
	R6[17:4]	RF_TOC	RF Timeout Counter	0	Disabled
R7	R7[13]	DIV4	Lock Detect Adjustment	0	Disabled (Fcomp ≤ 20 MHz)
	R7[7]	IF_RST	IF PLL Counter Reset	0	Disabled
	R7[6]	RF_RST	RF PLL Counter Reset	0	Disabled
	R7[5]	IF_CPT	IF PLL Tri-State	0	Disabled
	R7[4]	RF_CPT	RF PLL Tri-State	0	Disabled

Programming Description (Continued)

2.5 R4 REGISTER

This register controls the conditions for the RF PLL in Fastlock.

REGISTER	23	22	21	20	19	18	17	16	15	14	13	12	11	10	9	8	7	6	5	4	3	2	1	0
	DATA[19:0]																				C3	C2	C1	C0
R4	ATPU	0	1	0	0	0	DITH [1:0]	FM [1:0]	0	OSC_ 2X	OSC_ OUT	IF_ CPP	RF_ CPP	IF_P	MUX [3:0]	1	0	0	1					

2.5.1 MUX[3:0] Frequency Out & Lock Detect MUX

These bits determine the output state of the Ftest/LD pin.

MUX[3:0]				Output Type	Output Description
0	0	0	0	High Impedance	Disabled
0	0	0	1	Push-Pull	General purpose output, Logical "High" State
0	0	1	0	Push-Pull	General purpose output, Logical "Low" State
0	0	1	1	Push-Pull	RF & IF Digital Lock Detect
0	1	0	0	Push-Pull	RF Digital Lock Detect
0	1	0	1	Push-Pull	IF Digital Lock Detect
0	1	1	0	Open Drain	RF & IF Analog Lock Detect
0	1	1	1	Open Drain	RF Analog Lock Detect
1	0	0	0	Open Drain	IF Analog Lock Detect
1	0	0	1	Push-Pull	RF & IF Analog Lock Detect
1	0	1	0	Push-Pull	RF Analog Lock Detect
1	0	1	1	Push-Pull	IF Analog Lock Detect
1	1	0	0	Push-Pull	IF R Divider divided by 2
1	1	0	1	Push-Pull	IF N Divider divided by 2
1	1	1	0	Push-Pull	RF R Divider divided by 2
1	1	1	1	Push-Pull	RF N Divider divided by 2

2.5.2 IF_P -- IF Prescaler

When this bit is set to 0, the 8/9 prescaler is used. Otherwise the 16/17 prescaler is used.

IF_P	IF Prescaler	Maximum Frequency
0	8/9	800 MHz
1	16/17	800 MHz

2.5.3 RF_CPP -- RF PLL Charge Pump Polarity

RF_CPP	RF Charge Pump Polarity
0	Negative
1	Positive (Default)

2.5.4 IF_CPP -- IF PLL Charge Pump Polarity

For a positive phase detector polarity, which is normally the case, set this bit to 1. Otherwise set this bit for a negative phase detector polarity.

IF_CPP	IF Charge Pump Polarity
0	Negative
1	Positive

2.5.5 OSC_OUT Oscillator Output Buffer Enable

OSC_OUT	OSCOut Pin
0	Disabled (High Impedance)
1	Buffered output of OSCin pin

Programming Description (Continued)

2.5.6 OSC2X -- Oscillator Doubler Enable

When this bit is set to 0, the oscillator doubler is disabled and the TCXO frequency presented to the IF R and RF R counters is equal to that of the input frequency of the OSCin pin. When this bit is set to 1, the TCXO frequency presented to the RF R counter is doubled. Phase noise added by the doubler is negligible.

OSC2X	Frequency Presented to RF R Counter	Frequency Presented to IF R Counter
0	f_{OSCin}	f_{OSCin}
1	$2 \times f_{\text{OSCin}}$	

2.5.7 FM[1:0] -- Fractional Mode

Determines the order of the delta-sigma modulator. Higher order delta-sigma modulators reduce the spur levels closer to the carrier by pushing this noise to higher frequency offsets from the carrier. In general, the order of the loop filter should be at least one greater than the order of the delta-sigma modulator in order to allow for sufficient roll-off.

FM	Function
0	Fractional PLL mode with a 4th order delta-sigma modulator
1	Disable the delta-sigma modulator. Recommended for test use only.
2	Fractional PLL mode with a 2nd order delta-sigma modulator
3	Fractional PLL mode with a 3rd order delta-sigma modulator

2.5.8 DITH[1:0] -- Dithering Control

Dithering is a technique used to spread out the spur energy. Enabling dithering can reduce the main fractional spurs, but can also give rise to a family of smaller spurs. Whether dithering helps or hurts is application specific. Enabling the dithering may also increase the phase noise. In most cases where the fractional numerator is zero, dithering usually degrades performance.

Dithering tends to be most beneficial in applications where there is insufficient filtering of the spurs. This often occurs when the loop bandwidth is very wide or a higher order delta-sigma modulator is used. Dithering tends not to impact the main fractional spurs much, but has a much larger impact on the sub-fractional spurs. If it is decided that dithering will be used, best results will be obtained when the fractional denominator is at least 1000.

DITH	Dithering Mode Used
0	Disabled
1	Weak Dithering
2	Strong Dithering
3	Reserved

2.5.9 ATPU -- PLL Automatic Power Up

When this bit is set to 1, both the RF and IF PLL power up when the R0 register is written to. When the R0 register is written to, the PD_RF and PD_IF bits are changed to 0 in the PLL registers. The exception to this case is when the CE pin is low. In this case, the ATPU function is disabled.

Programming Description (Continued)

2.6 R5 REGISTER

REGISTER	23	22	21	20	19	18	17	16	15	14	13	12	11	10	9	8	7	6	5	4	3	2	1	0
	DATA[19:0]																				C3	C2	C1	C0
R5	RF_FD[21:12]										RF_FN[21:12]										1	0	1	1

2.6.1 Fractional Numerator Determination { RF_FN[21:12], RF_FN[11:0], ACCESS[1] }

In the case that the ACCESS[1] bit is 0, then the part operates in 12-bit fractional mode, and the RF_FN2[21:12] bits become do not care bits. When the ACCESS[1] bit is set to 1, the part operates in 22-bit mode and the fractional numerator is expanded from 12 to 22-bits.

Fractional Numerator	RF_FN[21:12]											RF_FN[11:0]																						
	(These bits only apply in 22- bit mode)																																	
0	In 12- bit mode, these are do not care. In 22- bit mode, for N <4096, these bits should be all set to 0.											0	0	0	0	0	0	0	0	0	0	0	0	0	0	0	0	0	0	0	0	0	0	
1												0	0	0	0	0	0	0	0	0	0	0	0	0	0	0	0	0	0	0	0	0	0	1
...											
4095												1	1	1	1	1	1	1	1	1	1	1	1	1	1	1	1	1	1	1	1	1	1	1
4096	0	0	0	0	0	0	0	0	0	0	0	1	0	0	0	0	0	0	0	0	0	0	0	0										
...										
4194303	1	1	1	1	1	1	1	1	1	1	1	1	1	1	1	1	1	1	1	1	1	1	1											

2.6.2 Fractional Denominator Determination { RF_FD[21:12], RF_FD[11:0], ACCESS[1]}

In the case that the ACCESS[1] bit is 0, then the part is operates in the 12-bit fractional mode, and the RF_FD[21:12] bits become do not care bits. When the ACCESS[1] is set to 1, the part operates in 22-bit mode and the fractional denominator is expanded from 12 to 22-bits.

Fractional Denominator	RF_FD[21:12]											RF_FD[11:0]																						
	(These bits only apply in 22- bit mode)																																	
0	In 12- bit mode, these are do not care. In 22- bit mode, for N <4096, these bits should be all set to 0.											0	0	0	0	0	0	0	0	0	0	0	0	0	0	0	0	0	0	0	0	0	0	
1												0	0	0	0	0	0	0	0	0	0	0	0	0	0	0	0	0	0	0	0	0	1	
...											
4095												1	1	1	1	1	1	1	1	1	1	1	1	1	1	1	1	1	1	1	1	1	1	1
4096	0	0	0	0	0	0	0	0	0	0	0	1	0	0	0	0	0	0	0	0	0	0	0											
...											
4194303	1	1	1	1	1	1	1	1	1	1	1	1	1	1	1	1	1	1	1	1	1	1	1											

Programming Description (Continued)

2.7 R6 REGISTER

REGISTER	23	22	21	20	19	18	17	16	15	14	13	12	11	10	9	8	7	6	5	4	3	2	1	0
	DATA[19:0]																				C3	C2	C1	C0
R6	CSR[1:0]		RF_CPF[3:0]			RF_TOC[13:0]															1	1	0	1

2.7.1 RF_TOC -- RF Time Out Counter and Control for FLoutRF Pin

The RF_TOC[13:0] word controls the operation of the RF Fastlock circuitry as well as the function of the FLoutRF output pin. When this word is set to a value between 0 and 3, the RF Fastlock circuitry is disabled and the FLoutRF pin operates as a general purpose CMOS TRI-STATE I/O. When RF_TOC is set to a value between 4 and 16383, the RF Fastlock mode is enabled and the FLoutRF pin is utilized as the RF Fastlock output pin. The value programmed into the RF_TOC[13:0] word represents two times the number of phase detector comparison cycles the RF synthesizer will spend in the Fastlock state.

RF_TOC	Fastlock Mode	Fastlock Period [CP events]	FLoutRF Pin Functionality
0	Disabled	N/A	High Impedance
1	Manual	N/A	Logic "0" State. Forces all Fastlock conditions
2	Disabled	N/A	Logic "0" State
3	Disabled	N/A	Logic "1" State
4	Enabled	4X2 = 8	Fastlock
5	Enabled	5X2 = 10	Fastlock
...	Enabled	...	Fastlock
16383	Enabled	16383X2 = 32766	Fastlock

2.7.2 RF_CPF -- RF PLL Fastlock Charge Pump Current

Specify the charge pump current for the Fastlock operation mode for the RF PLL. Note that the Fastlock charge pump current, steady state current, and CSR control are all interrelated.

RF_CPF	RF Charge Pump State	Typical RF Charge Pump Current at 3 Volts (μ A)
0	1X	95
1	2X	190
2	3X	285
3	4X	380
4	5X	475
5	6X	570
6	7X	665
7	8X	760
8	9X	855
9	10X	950
10	11X	1045
11	12X	1140
12	13X	1235
13	14X	1330
14	15X	1425
15	16X	1520

Programming Description (Continued)

2.7.3 CSR[1:0] -- RF Cycle Slip Reduction

CSR controls the operation of the Cycle Slip Reduction Circuit. This circuit can be used to reduce the occurrence of phase detector cycle slips. Note that the Fastlock charge pump current, steady state current, and CSR control are all interrelated. Refer to section 1.8 for information on how to use this.

CSR	CSR State	Sample Rate Reduction Factor
0	Disabled	1
1	Enabled	1/2
2	Enabled	1/4
3	Enabled	1/16

Programming Description (Continued)

2.8 R7 REGISTER

REGISTER	23	22	21	20	19	18	17	16	15	14	13	12	11	10	9	8	7	6	5	4	3	2	1	0
	Data[19:0]																				C3	C2	C1	C0
R7	0	0	0	0	0	0	0	0	0	0	0	0	1	0	0	0	IF_RST	RF_RST	IF_CPT	RF_CPT	1	1	1	1

2.8.1 DIV4 -- RF Digital Lock Detect Divide By 4

Because the digital lock detect function is based on a phase error, it becomes more difficult to detect a locked condition for larger comparison frequencies. When this bit is enabled, it subdivides the RF PLL comparison frequency (it does not apply to the IF comparison frequency) presented to the digital lock detect circuitry by 4. This enables this circuitry to work at higher comparison frequencies. It is recommended that this bit be enabled whenever the comparison frequency exceeds 20 MHz and RF digital lock detect is being used.

2.8.2 IF_RST -- IF PLL Counter Reset

When this bit is enabled, the IF PLL N and R counters are reset, and the charge pump is put in a Tri-State condition. This feature should be disabled for normal operation. Note that a counter reset is applied whenever the chip is powered up via software or CE pin.

IF_RST	IF PLL N and R Counters	IF PLL Charge Pump
0 (Default)	Normal Operation	Normal Operation
1	Counter Reset	Tri-State

2.8.3 RF_RST -- RF PLL Counter Reset

When this bit is enabled, the RF PLL N and R counters are reset and the charge pump is put in a Tri-State condition. This feature should be disabled for normal operation. Note that a counter reset is applied whenever the chip is powered up via software or CE pin.

RF_RST	RF PLL N and R Counters	RF PLL Charge Pump
0 (Default)	Normal Operation	Normal Operation
1	Counter Reset	Tri-State

2.8.4 RF_TRI -- RF Charge Pump Tri-State

When this bit is enabled, the RF PLL charge pump is put in a Tri-State condition, but the counters are not reset. This feature is typically disabled for normal operation.

RF_TRI	RF PLL N and R Counters	RF PLL Charge Pump
0 (Default)	Normal Operation	Normal Operation
1	Normal Operation	Tri-State

2.8.5 IF_TRI -- IF Charge Pump Tri-State

When this bit is enabled, the IF PLL charge pump is put in a Tri-State condition, but the counters are not reset. This feature is typically disabled for normal operation.

IF_TRI	IF PLL N and R Counters	IF PLL Charge Pump
0 (Default)	Normal Operation	Normal Operation
1	Normal Operation	Tri-State

Physical Dimensions inches (millimeters) unless otherwise noted

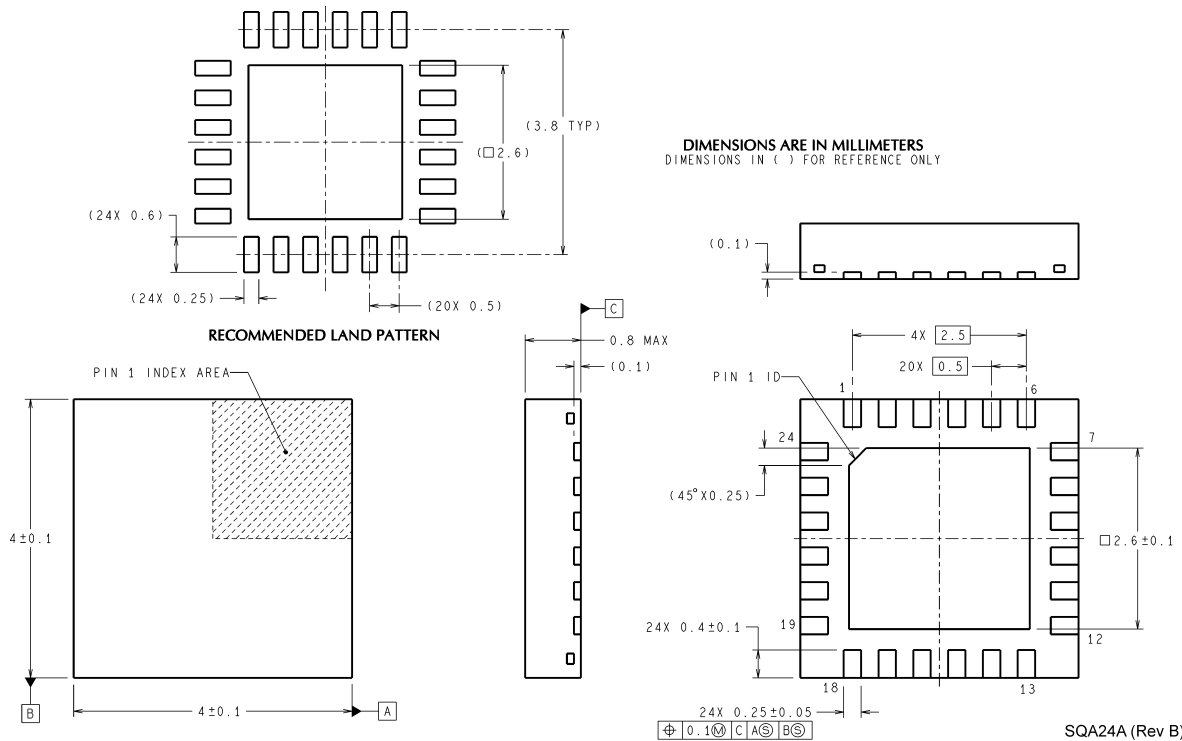

Plastic Quad LLP (SQ), Bottom View
Order Number LMX2485SQ or LMX2485ESQ for 1000 Unit Reel
Order Number LMX2485SQX or LMX2485ESQX for 4500 Unit Reel
NS Package Number SQA24A

National does not assume any responsibility for use of any circuitry described, no circuit patent licenses are implied and National reserves the right at any time without notice to change said circuitry and specifications.
 For the most current product information visit us at www.national.com.

LIFE SUPPORT POLICY

NATIONAL'S PRODUCTS ARE NOT AUTHORIZED FOR USE AS CRITICAL COMPONENTS IN LIFE SUPPORT DEVICES OR SYSTEMS WITHOUT THE EXPRESS WRITTEN APPROVAL OF THE PRESIDENT AND GENERAL COUNSEL OF NATIONAL SEMICONDUCTOR CORPORATION. As used herein:

1. Life support devices or systems are devices or systems which, (a) are intended for surgical implant into the body, or (b) support or sustain life, and whose failure to perform when properly used in accordance with instructions for use provided in the labeling, can be reasonably expected to result in a significant injury to the user.
2. A critical component is any component of a life support device or system whose failure to perform can be reasonably expected to cause the failure of the life support device or system, or to affect its safety or effectiveness.

BANNED SUBSTANCE COMPLIANCE

National Semiconductor manufactures products and uses packing materials that meet the provisions of the Customer Products Stewardship Specification (CSP-9-111C2) and the Banned Substances and Materials of Interest Specification (CSP-9-111S2) and contain no "Banned Substances" as defined in CSP-9-111S2.
 Leadfree products are RoHS compliant.



National Semiconductor
Americas Customer Support Center
 Email: new.feedback@nsc.com
 Tel: 1-800-272-9959

National Semiconductor
Europe Customer Support Center
 Fax: +49 (0) 180-530 85 86
 Email: europe.support@nsc.com
 Deutsch Tel: +49 (0) 69 9508 6208
 English Tel: +44 (0) 870 24 0 2171
 Français Tel: +33 (0) 1 41 91 8790

National Semiconductor
Asia Pacific Customer Support Center
 Email: ap.support@nsc.com

National Semiconductor
Japan Customer Support Center
 Fax: 81-3-5639-7507
 Email: jpn.feedback@nsc.com
 Tel: 81-3-5639-7560

www.national.com