

LMX1600/LMX1601/LMX1602 PLLatinum™ Low Cost Dual Frequency Synthesizer

LMX1600 2.0 GHz/500 MHz
LMX1601 1.1 GHz/500 MHz
LMX1602 1.1 GHz/1.1 GHz

General Description

The LMX1600/01/02 is part of a family of monolithic integrated dual frequency synthesizers designed to be used in a local oscillator subsystem for a radio transceiver. It is fabricated using National's 0.5u ABiC V silicon BiCMOS process. The LMX1600/01/02 contains two dual modulus prescalers, four programmable counters, two phase detectors and two selectable gain charge pumps necessary to provide the control voltage for two external loop filters and VCO loops. Digital filtered lock detects for both PLLs are included. Data is transferred into the LMX1600/01/02 via a MICROWIRE™ serial interface (Data, Clock, LE).

V_{CC} supply voltage can range from 2.7V to 3.6V. The LMX1600/01/02 features very low current consumption - typically 4.0 mA at 3V for LMX1601, 5.0 mA at 3V for LMX1600 or LMX1602. Powerdown for the PLL is hardware controlled.

The LMX1600/01/02 is available in a 16 pin TSSOP surface mount plastic package.

Features

- $V_{CC} = 2.7V$ to 3.6V operation
- Low current consumption:
 - 4 mA @ 3V (typ) for LMX1601
 - 5 mA @ 3V (typ) for LMX1600 or LMX1602
- PLL Powerdown mode: $I_{CC} = 1 \mu A$ typical
- Dual modulus prescaler:
 - 2 GHz/500 MHz option: (Main) 32/33 (Aux) 8/9
 - 1.1 GHz/500 MHz option: (Main) 16/17 (Aux) 8/9
 - 1.1 GHz/1.1 GHz option: (Main) 16/17 (Aux) 16/17
- Digital Filtered Lock Detects

Applications

- Cordless / Cellular / PCS phones
- Other digital mobile phones

Functional Block Diagram

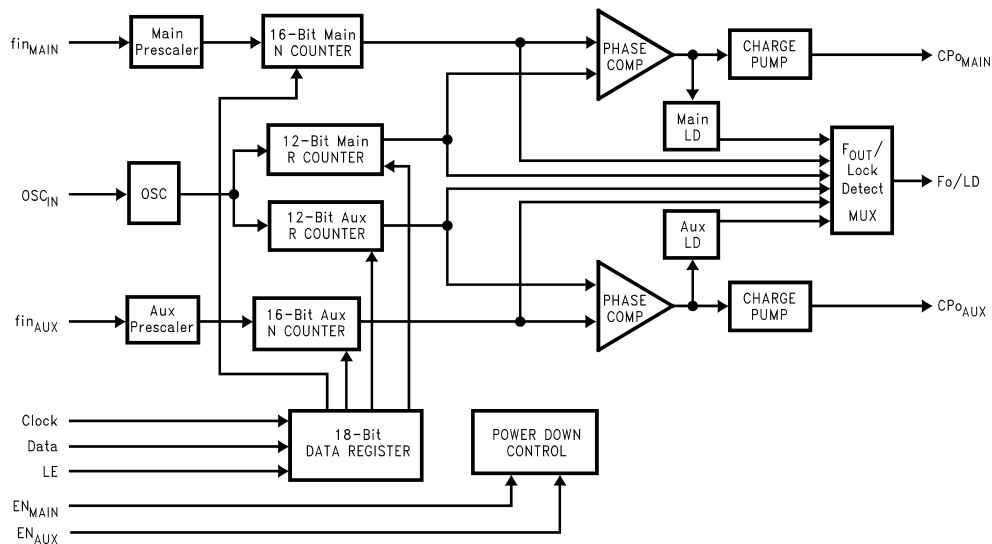

DS100129-1

TRI-STATE® is a registered trademark of National Semiconductor Corporation.
MICROWIRE™ and PLLatinum™ are trademarks of National Semiconductor Corporation.

Connection Diagram

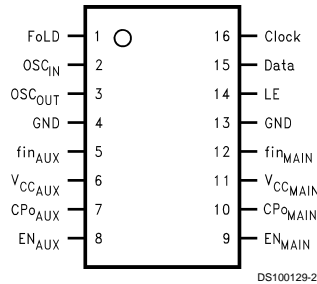

DS100129-2

Order Number LMX1600TM, LMX1601TM, or LMX1602TM
NS Package Number MTC16

Pin Description

Pin No.	Pin Name	I/O	Description
1	FoLD	O	Multiplexed output of the Main/Aux programmable or reference dividers and Main/Aux lock detect. CMOS output. (See Programming Description 2.5)
2	OSC _{IN}	I	PLL reference input which drives both the Main and Aux R counter inputs. Has about 1.2V input threshold and can be driven from an external CMOS or TTL logic gate. Typically connected to a TCXO output. Can be used with an external resonator (See Programming Description 2.5.4).
3	OSC _{OUT}	O	Oscillator output. Used with an external resonator.
4	GND	—	Aux PLL ground.
5	fin _{AUX}	I	Aux prescaler input. Small signal input from the VCO.
6	V _{CC} _{AUX}	—	Aux PLL power supply voltage input. Must be equal to V _{CC} _{MAIN} . May range from 2.7V to 3.6V. Bypass capacitors should be placed as close as possible to this pin and be connected directly to the ground plane.
7	CPO _{AUX}	O	Aux PLL Charge Pump output. Connected to a loop filter for driving the control input of an external VCO.
8	EN _{AUX}	I	Powers down the Aux PLL when LOW (N and R counters, prescaler, and tristates charge pump output). Bringing EN _{AUX} HIGH powers up the Aux PLL.
9	EN _{MAIN}	I	Powers down the Main PLL when LOW (N and R counters, prescaler, and tristates charge pump output). Bringing EN _{MAIN} HIGH powers up the Main PLL.
10	CPO _{MAIN}	O	Main PLL Charge Pump output. Connected to a loop filter for driving the control input of an external VCO.
11	V _{CC} _{MAIN}	—	Main PLL power supply voltage input. Must be equal to V _{CC} _{AUX} . May range from 2.7V to 3.6V. Bypass capacitors should be placed as close as possible to this pin and be connected directly to the ground plane.
12	fin _{MAIN}	I	Main prescaler input. Small signal input from the VCO.
13	GND	—	Main PLL ground.
14	LE	I	Load enable high impedance CMOS input. Data stored in the shift registers is loaded into one of the 4 internal latches when LE goes HIGH (control bit dependent).
15	Data	I	High impedance CMOS input. Binary serial data input. Data entered MSB first. The last two bits are the control bits.
16	Clock	I	High impedance CMOS Clock input. Data for the various counters is clocked in on the rising edge, into the 18-bit shift register.

Absolute Maximum Ratings (Notes 1, 2)

If Military/Aerospace specified devices are required, please contact the National Semiconductor Sales Office/ Distributors for availability and specifications.

Parameter	Symbol	Value			Unit
		Min	Typical	Max	
Power Supply Voltage	V_{CCMAIN}	-0.3		6.5	V
	V_{CCAUX}	-0.3		6.5	V
Voltage on any pin with GND=0V	V_i	-0.3		$V_{CC} + 0.3$	V
Storage Temperature Range	T_S	-65		+150	°C
Lead Temp. (solder 4 sec)	T_L			+260	°C
ESD-Human Body Model (Note 2)			2000		eV

Recommended Operating Conditions

Parameter	Symbol	Value			Unit
		Min	Typical	Max	
Power Supply Voltage	V_{CCMAIN}	2.7		3.6	V
	V_{CCAUX}	V_{CCMAIN}		V_{CCMAIN}	V
Operating Temperature	T_A	-40		+85	°C

Note 1: "Absolute Maximum Ratings" indicate limits beyond which damage to the device may occur. Recommended Operating Conditions indicate conditions for which the device is intended to be functional, but do not guarantee specific performance limits. Electrical Characteristics document specific minimum and/or maximum performance values at specified test conditions and are guaranteed. Typical values are for informational purposes only - based on design parameters or device characterization and are not guaranteed.

Note 2: This device is a high performance RF integrated circuit and is ESD sensitive. Handling and assembly of this device should only be done on ESD-free workstations.

Electrical Characteristics

($V_{CCMAIN} = V_{CCAUX} = 3.0V$; $T_A = 25^\circ C$ except as specified)

Symbol	Parameter	Conditions	Min	Typ	Max	Units
GENERAL						
I_{CC}	Power Supply Current	2 GHz + 500 MHz	Crystal Mode (Note 3)		5.0	mA
		1.1 GHz + 500 MHz	Crystal Mode (Note 3)		4.0	mA
		1.1 GHz + 1.1 GHz	Crystal Mode (Note 3)		5.0	mA
		2 GHz Only	Crystal Mode (Note 3)		3.5	mA
		1.1 GHz Only	Crystal Mode (Note 3)		2.5	mA
		500 MHz Only	Crystal Mode (Note 3)		1.5	mA
$I_{CC-PWDN}$	Power Down Current	$EN_{MAIN} = LOW, EN_{AUX} = LOW$		1		μA
f_{in}	fin Operating Frequency	fin Main 2 GHz Option		200	2000	MHz
		fin Main and Aux 1.1 GHz Option		100	1100	MHz
		fin Aux 500 MHz Option		40	500	MHz
OSC_{IN}	Oscillator Operating Frequency	Logic Mode (Note 3)		1	40	MHz
		Crystal Mode (Note 3)		1	20	MHz
V_{OSC}	Oscillator Input Sensitivity		0.5		V_{CC}	V_{PP}
f_{ϕ}	Maximum Phase Detector Frequency			10		MHz
Pfin	Main and Aux RF Input Sensitivity		-15		0	dBm
CHARGE PUMP						
$ICP_{o-source}$	RF Charge Pump Output Current (See Programming Description 2.4)	$V_{CP0} = V_{CC}/2$, High Gain Mode		-1600		μA
ICP_{o-sink}		$V_{CP0} = V_{CC}/2$, High Gain Mode		1600		μA
$ICP_{o-source}$		$V_{CP0} = V_{CC}/2$, Low Gain Mode		-160		μA
ICP_{o-sink}		$V_{CP0} = V_{CC}/2$, Low Gain Mode		160		μA
ICP_{o-Tri}	Charge Pump TRI-STATE® Current	$0.5 \leq V_{CP0} \leq V_{CC}-0.5$		1		nA
DIGITAL INTERFACE (DATA, CLK, LE, EN, FoLD)						
V_{IH}	High-Level Input Voltage			$0.8V_{CC}$		V
V_{IL}	Low-Level Input Voltage				$0.2V_{CC}$	V

Electrical Characteristics (Continued)

($V_{CC_{MAIN}} = V_{CC_{AUX}} = 3.0V$; $T_A = 25^\circ C$ except as specified)

Symbol	Parameter	Conditions	Min	Typ	Max	Units
DIGITAL INTERFACE (DATA, CLK, LE, EN, FoLD)						
I_{IH}	High-Level Input Current	$V_{IH} = V_{CC} = 3.6V$, (Note 4)	-1.0		1.0	μA
I_{IL}	Low-Level Input Current	$V_{IL} = 0V$; $V_{CC} = 3.6V$, (Note 4)	-1.0		1.0	μA
I_{IH}	OSC _{IN} Input Current	$V_{IH} = V_{CC} = 3.6V$			100	μA
I_{IL}	OSC _{IN} Input Current	$V_{IL} = 0V$; $V_{CC} = 3.6V$	-100			μA
I_O	OSC _{OUT} Output Current Magnitude (sink/source) (Note 5)	Logic Mode $V_{CC} = 3.6V$ (Note 3)			[200]	μA
		Crystal Mode $V_{CC} = 2.7V$ (Note 3)	[300]			μA
V_{OH}	High-Level Output Voltage	$I_{OH} = -500 \mu A$	$V_{CC}-0.4$			V
V_{OL}	Low-Level Output Voltage	$I_{OL} = 500 \mu A$			0.4	V
MICROWIRE TIMING						
t_{CS}	Data to Clock Set Up Time	See Data Input Timing	50			ns
t_{CH}	Data to Clock Hold Time	See Data Input Timing	10			ns
t_{CWH}	Clock Pulse Width High	See Data Input Timing	50			ns
t_{CWL}	Clock Pulse Width Low	See Data Input Timing	50			ns
t_{ES}	Clock to Load Enable Set Up Time	See Data Input Timing	50			ns
t_{EW}	Load Enable Pulse Width	See Data Input Timing	50			ns
CLOSED LOOP SYNTHESIZER PERFORMANCE (NSC evaluation board only)						
$RF\phi_n$	Main PLL Phase Noise Floor	(Note 6)		-160		dBc/Hz

Note 3: Refer to Programming Description 2.5.3.

Note 4: Except fin.

Note 5: The OSCout Output Current Magnitude is less than or equal to 200 μA when the Logic Mode is selected. The OSCout Output Current Magnitude is greater than or equal to 300 μA when the Crystal Mode is selected.

Note 6: Offset frequency = 1 kHz, fin = 900 MHz, f ϕ = 25 kHz, N = 3600, fOSC = 10 MHz, VOSC > 1.2 Vpp. Refer to the Application Note, AN-1052, for description of phase noise floor measurement.

1.0 Functional Description

The basic phase-lock-loop (PLL) configuration consists of a high-stability crystal reference oscillator, a frequency synthesizer such as the National Semiconductor LMX1600/01/02, a voltage controlled oscillator (VCO), and a passive loop filter. The frequency synthesizer includes a phase detector, current mode charge pump, as well as programmable reference [R], and feedback [N] frequency dividers. The VCO frequency is established by dividing the crystal reference signal down via the R counter to obtain the comparison frequency. This reference signal, f_r , is then presented to the input of a phase/frequency detector and compared with another signal, f_p , the feedback signal, which was obtained by dividing the VCO frequency down using the N counter. The phase/frequency detector's current source outputs pump charge into the loop filter, which then converts the charge into the VCO's control voltage. The phase/frequency comparator's function is to adjust the voltage presented to the VCO until the feedback signal's frequency (and phase) match that of the reference signal. When this "phase-locked" condition exists, the VCO's frequency will be N times that of the comparison frequency, where N is the divider ratio.

1.1 REFERENCE OSCILLATOR INPUTS

The reference oscillator frequency for the Main and Aux PLL's is provided by either an external reference through the OSC_{IN} pin with the OSC_{OUT} pin not connected or connected to a 30 pF capacitor to ground in Logic Mode, or an external crystal resonator across the OSC_{IN} and OSC_{OUT} pins in Crystal Mode (See Programming Description 2.5.3). The OSC_{IN} input can operate to 40 MHz in Logic Mode or to 20 MHz in Crystal Mode with an input sensitivity of $0.5 V_{PP}$. The OSC_{IN} pin drives the Main and Aux R counters. The inputs have a $\sim 1.2V$ input threshold and can be driven from an external CMOS or TTL logic gate. The OSC_{IN} pin is typically connected to the output of a Temperature Compensated Crystal Oscillator (TCXO).

1.2 REFERENCE DIVIDERS (R COUNTERS)

The Main and Aux R Counters are clocked through the oscillator block in common. The maximum frequency is 40 MHz in Logic Mode or 20 MHz in crystal Mode. Both R Counters are 12-bit CMOS counters with a divide range from 2 to 4,095. (See Programming Description 2.2)

1.3 FEEDBACK DIVIDERS (N COUNTERS)

The Main and Aux N Counters are clocked by the small signal fin Main and fin Aux input pins respectively. These inputs should be AC coupled through external capacitors. The Main N counter has an 16-bit equivalent integer divisor configured as a 5-bit A Counter and an 11-bit B Counter offering a continuous divide range from 992 to 65,535 (2 GHz option) or a 4-bit A Counter and a 12-bit B Counter offering a continuous divide range from 240 to 65,535 (1.1 GHz option). The Main N divider incorporates a 32/33 dual modulus prescaler capable of operation from 200 MHz to 2.0 GHz or a 16/17 dual modulus prescaler capable of operation from 100 MHz to 1.1 GHz.

The Aux N divider operates from 100 MHz to 1.1 GHz with a 16/17 prescaler or from 40 MHz to 500 MHz with a 8/9 prescaler. The Aux N counter is a 16-bit integer divider fully programmable from 240 to 65,535 over the frequency range of 100 MHz to 1.1 GHz or from 56 to 32,767 over the frequency range of 40 MHz to 550 MHz. The Aux N counter is config-

ured as a 4-bit A Counter and a 12-bit B Counter. These inputs should be AC coupled through external capacitors. (See Programming Description 2.3)

1.3.1 Prescalers

The RF input to the prescalers consists of the fin pins which are one of two complimentary inputs to a differential pair amplifier. The complimentary inputs are internally coupled to ground with a 10 pF capacitor and not brought out to a pin. The input buffer drives the A counter's ECL D-type flip flops in a dual modulus configuration. A 32/33 for 2.0 GHz option, 16/17 for 1.1 GHz option, or 8/9 for 500 MHz option prescale ratio is provided for the LMX1600/01/02. The prescaler clocks the subsequent CMOS flip-flop chain comprising the fully programmable A and B counters.

1.4 PHASE/FREQUENCY DETECTOR

The Main and Aux phase(/frequency) detectors are driven from their respective N and R counter outputs. The maximum frequency at the phase detector inputs is 10 MHz (unless limited by the minimum continuous divide ratio of the multi modulus prescalers). The phase detector outputs control the charge pumps. The polarity of the pump-up or pump-down control is programmed using **Main_PD_Pol** or **Aux_PD_Pol** depending on whether Main or Aux VCO characteristics are positive or negative. (See Programming Description 2.4) The phase detector also receives a feedback signal from the charge pump in order to eliminate dead zone.

1.5 CHARGE PUMP

The phase detector's current source outputs pump charge into an external loop filter, which then converts the charge into the VCO's control voltage. The charge pumps steer the charge pump output, CPo, to V_{CC} (pump-up) or ground (pump-down). When locked, CPo is primarily in a TRI-STATE mode with small corrections. The charge pump output current magnitude can be selected as 160 μA or 1600 μA using bits **AUX_CP_GAIN** and **MAIN_CP_GAIN** as shown in Programming Description 2.4.

1.7 MICROWIRE SERIAL INTERFACE

The programmable functions are accessed through the MICROWIRE serial interface. The interface is made of 3 functions: clock, data, and latch enable (LE). Serial data for the various counters is clocked in from data on the rising edge of clock, into the 18-bit shift register. Data is entered MSB first. The last two bits decode the internal register address. On the rising edge of LE, data stored in the shift register is loaded into one of the 4 appropriate latches (selected by address bits). Data is loaded from the latch to the counter when counter reaches to zero. A complete programming description is included in the following sections.

1.8 FoLD MULTIFUNCTION OUTPUT

The LMX1600/01/02 programmable output pin (FoLD) can deliver the internal counter outputs, digital lock detects, or CMOS high/low levels.

1.8.1 Lock Detect

A digital filtered lock detect function is included with each phase detector through an internal digital filter to produce a logic level output available on the Fo/LD output pin, if selected. The lock detect output is high when the error between

1.0 Functional Description (Continued)

the phase detector inputs is less than 15 ns for 4 consecutive comparison cycles. The lock detect output is low when the error between the phase detector outputs is more than 30 ns for one comparison cycle. The lock detect output is always low when the PLL is in power down mode. For further description see Programming Description 2.5.

1.9 POWER CONTROL

Each PLL is individually power controlled by the device **EN** pin. The **EN_{MAIN}** controls the Main PLL, and the **EN_{AUX}** controls the Aux PLL. Activation of **EN = LOW** (power down) condition results in the disabling of the respective N and R counters and de-biasing of their respective fin inputs (to a high impedance state). The reference oscillator input block powers down and the **OSC_{IN}** pin reverts to a high impedance state only when both **EN** pins are LOW. Power down forces the respective charge pump and phase comparator logic to a TRI-STATE condition as well as disabling the bandgap reference block. Power up occurs immediately when the **EN** pin is brought high. Power up sequence: Bandgap and Oscillator blocks come up first, with the remaining PLL functions becoming active approx. 1 μ s later. All programming information is retained internally in the chip when in power down mode. The MICROWIRE control register remains active and capable of loading and latching in data during power down mode.

2.0 Programming Description

2.1 MICROWIRE INTERFACE

The descriptions below detail the 18-bit data register loaded through the MICROWIRE Interface. The 18-bit shift register is used to program the 12-bit Main and Aux R counter registers and the 16-bit Main and Aux N counter registers. The shift register consists of a 16-bit DATA field and a 2-bit control (CTL [1:0]) field as shown below. The control bits decode the internal register address. On the rising edge of LE, data stored in the shift register is loaded into one of the 4 appropriate latches (selected by address bits). Data is shifted in MSB first.

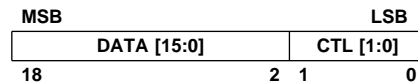

2.1.1 Register Location Truth Table

When LE transitions high, data is transferred from the 18-bit shift register into one of the 4 appropriate internal latches depending upon the state of the control (CTL) bits. The control bits decode the internal register address

CTL [1:0]		DATA Location
0	0	AUX_R Register
0	1	AUX_N Register
1	0	MAIN_R Register
1	1	MAIN_N Register

2.1.2 Register Content Truth Table

	SHIFT REGISTER BIT LOCATION															Last Bit	
	17	16	15	14	13	12	11	10	9	8	7	6	5	4	3	2	1
AUX_R	FoLD				AUX_R_CNTR											0	0
AUX_N					AUX_B_CNTR						AUX_A_CNTR					0	1
MAIN_R	CP_WORD				MAIN_R_CNTR											1	0
MAIN_N	MAIN_B_CNTR and MAIN_A_CNTR															1	1

2.2 PROGRAMMABLE REFERENCE DIVIDERS

2.2.1 AUX_R Register

If the Control Bits (CTL [1:0]) are 0 0 when LE transitions high, data is transferred from the 18-bit shift register into a latch which sets the Aux PLL 12-bit R counter divide ratio. The divide ratio is programmed using the bits **AUX_R_CNTR** as shown in table 2.2.3. The divider ratio must be ≥ 2 . The FoLD word bits controls the multifunction FoLD output as described in section in 2.5.

	SHIFT REGISTER BIT LOCATION															Last Bit	
	17	16	15	14	13	12	11	10	9	8	7	6	5	4	3	2	1
AUX_R	FoLD[3:0]				AUX_R_CNTR[11:0]											0	0

2.0 Programming Description (Continued)

2.2.2 MAIN_R REGISTER

If the Control Bits (CTL[1:0]) are 1 0 when LE transitions high, data is transferred from the 18-bit shift register into a latch which sets the Main PLL 12-bit R counter divide ratio and various control functions. The divide ratio is programmed using the bits **MAIN_R_CNTR** as shown in table 2.2.3. The divider ratio must be ≥ 2 . The charge pump control word (CP_WORD[3:0]) sets the charge pump gain and the phase detector polarity as detailed in 2.4.

	SHIFT REGISTER BIT LOCATION																	
	17	16	15	14	13	12	11	10	9	8	7	6	5	4	3	2	1	0
MAIN_R	CP_WORD[3:0]			MAIN_R_CNTR[11:0]													1	0

2.2.3 12-Bit Programmable Main and Auxiliary Reference Divider Ratio (MAIN/AUX R Counter)

MAIN_R_CNTR/AUX_R_CNTR												
Divide Ratio	11	10	9	8	7	6	5	4	3	2	1	0
2	0	0	0	0	0	0	0	0	0	0	1	0
3	0	0	0	0	0	0	0	0	0	0	1	1
•	•	•	•	•	•	•	•	•	•	•	•	•
4,095	1	1	1	1	1	1	1	1	1	1	1	1

Note 7: Legal divide ratio: 2 to 4,095.

2.3 PROGRAMMABLE FEEDBACK (N) DIVIDERS

2.3.1 AUX_N Register

If the Control Bits (CTL[1:0]) are 0 1 when LE transitions high, data is transferred from the 18-bit shift register into the AUX_N register latch which sets the Aux PLL 16-bit programmable N counter value. The AUX_N counter is a 16-bit counter which is fully programmable from 240 to 65,535 for 1.1 GHz option or from 56 to 32,767 for 500 MHz option. The AUX_N register consists of the 4-bit swallow counter (AUX_A_CNTR), the 12-bit programmable counter (AUX_B_CNTR). Serial data format is shown below. The divide ratio (AUX_N_CNTR [13:0]) must be ≥ 240 (1.1 GHz option) or ≥ 56 (500 MHz option) for a continuous divide range. The Aux PLL N divide ratio is programmed using the bits AUX_A_CNTR, AUX_B_CNTR as shown in tables 2.3.2.

	SHIFT REGISTER BIT LOCATION																
	17	16	15	14	13	12	11	10	9	8	7	6	5	4	3	2	1
AUX_N	AUX_B_CNTR[11:0]												AUX_A_CNTR[3:0]			0	1

2.3.2 4-BIT Swallow Counter Divide Ratio (Aux A COUNTER)

1.1 GHz option

Swallow Count	AUX_A_CNTR			
(A)	3	2	1	0
0	0	0	0	0
1	0	0	0	1
•	•	•	•	•
15	1	1	1	1

Note 8: Swallow Counter Value: 0 to 15

500 MHz option

Swallow Count	AUX_A_CNTR			
(A)	3	2	1	0
0	X	0	0	0
1	X	0	0	1
•	•	•	•	•
7	X	1	1	1

Note 9: Swallow Counter Value: 0 to 7

X = Don't Care condition

2.3.3 12-BIT Programmable Counter Divide Ratio (Aux B COUNTER)

AUX_B_CNTR												
Divide Ratio	11	10	9	8	7	6	5	4	3	2	1	0
3	0	0	0	0	0	0	0	0	0	0	1	1
4	0	0	0	0	0	0	0	0	0	1	0	0
•	•	•	•	•	•	•	•	•	•	•	•	•
4,095	1	1	1	1	1	1	1	1	1	1	1	1

Note 10: Divide ratio: 3 to 4,095 (Divide ratios less than 3 are prohibited)

AUX_B_CNTR \geq AUX_A_CNTR.

See section 2.3.7 for calculation of VCO output frequency.

2.0 Programming Description (Continued)

2.3.4 MAIN_N Register

If the Control Bits (CTL[1:0]) are 1 1 when LE transitions high, data is transferred from the 18-bit shift register into the MAIN_N register latch which sets 16-bit programmable N divider value. The Main N divider is a 16-bit counter which is fully programmable from 992 to 65,535 for 2 GHz option and from 240 to 65,535 for 1.1 GHz option. The MAIN_N register consists of the 5-bit (2 GHz option) or 4-bit (1.1 GHz option) swallow counter (MAIN_A_CNTR) and the 11-bit (2 GHz option) or 12-bit (1.1 GHz option) programmable counter (MAIN_B_CNTR). Serial data format for the MAIN_N register latch shown below. The divide ratio must be ≥ 992 (2 GHz option) or 240 (1.1 GHz option) for a continuous divide range. The divide ratio is programmed using the bits MAIN_A_CNTR and MAIN_B_CNTR as shown in tables 2.3.5 and 2.3.6 The pulse swallow function which determines the divide ratio is described in Section 2.3.7.

2 GHz option

	SHIFT REGISTER BIT LOCATION																
	17	16	15	14	13	12	11	10	9	8	7	6	5	4	3	2	1
MAIN_N	AUX_B_CNTR[10:0]										AUX_A_CNTR[4:0]				1	1	

1.1 GHz option

	SHIFT REGISTER BIT LOCATION																
	17	16	15	14	13	12	11	10	9	8	7	6	5	4	3	2	1
MAIN_N	AUX_B_CNTR[11:0]											AUX_A_CNTR[3:0]				1	1

2.3.5 Swallow Counter Divide Ratio (Main A COUNTER)

2 GHz option (5 bit)

Swallow Count	MAIN_A_CNTR				
(A)	4	3	2	1	0
0	0	0	0	0	0
1	0	0	0	0	1
•	•	•	•	•	•
31	1	1	1	1	1

Note 11: Swallow Counter Value: 0 to 31

1.1 GHz option (4 bit)

Swallow Count	MAIN_A_CNTR			
(A)	3	2	1	0
0	0	0	0	0
1	0	0	0	1
•	•	•	•	•
15	1	1	1	1

Note 12: Swallow Counter Value: 0 to 15

2.3.6 Programmable Counter Divide Ratio (Main B COUNTER)

2 GHz option (11 bit)

Divide Ratio	MAIN_B_CNTR										
	10	9	8	7	6	5	4	3	2	1	0
3	0	0	0	0	0	0	0	0	0	1	1
4	0	0	0	0	0	0	0	0	1	0	0
•	•	•	•	•	•	•	•	•	•	•	•
2,047	1	1	1	1	1	1	1	1	1	1	1

Note 13: Divide ratio: 3 to 2,047 (Divide ratios less than 3 are prohibited)

MAIN_B_CNTR \geq MAIN_A_CNTR.

See section 2.3.7 for calculation of VCO output frequency.

2.0 Programming Description (Continued)

1.1 GHz option (12 bit)

MAIN_B_CNTR												
Divide Ratio	11	10	9	8	7	6	5	4	3	2	1	0
3	0	0	0	0	0	0	0	0	0	0	1	1
4	0	0	0	0	0	0	0	0	0	1	0	0
•	•	•	•	•	•	•	•	•	•	•	•	•
4,095	1	1	1	1	1	1	1	1	1	1	1	1

Note 14: Divide ratio: 3 to 4,095 (Divide ratios less than 3 are prohibited)
 MAIN_B_CNTR ≥ MAIN_A_CNTR.
 See section 2.3.7 for calculation of VCO output frequency.

2.3.7 Pulse Swallow Function

The N divider counts such that it divides the VCO RF frequency by (P+1) for A times, and then divides by P for (B – A) times. The B value (B_CNTR) must be ≥ 3. The continuous divider range for the Main PLL N divider is from 992 to 65,535 for 2 GHz option, from 240 to 65,535 for 1.1 GHz option, and from 56 to 32,767 for 500 MHz option. Divider ratios less than the minimum value are achievable as long as the binary counter value is greater than or equal to the swallow counter value (B_CNTR ≥ A_CNTR).

$$f_{VCO} = N \times (f_{OSC} / R)$$

$$N = (P \times B) + A$$

f_{VCO} : Output frequency of external voltage controlled oscillator (VCO)

f_{OSC} : Output frequency of the external reference frequency oscillator (input to OSC_{IN}).

R: Preset divide ratio of binary programmable reference counter (R_CNTR)

N: Preset divide ratio of main programmable integer N counter (N_CNTR)

B: Preset divide ratio of binary programmable B counter (B_CNTR)

A: Preset value of binary 4-bit swallow A counter (A_CNTR)

P: Preset modulus of dual modulus prescaler (P = 32 for 2 GHz option, P=16 for 1.1 GHz option, and P=8 for 500 MHz option)

2.4 CHARGE PUMP CONTROL WORD (CP_WORD)

MSB		LSB	
AUX_CP_GAIN	MAIN_CP_GAIN	AUX_PD_POL	MAIN_PD_POL

BIT	LOCATION	FUNCTION	0	1
AUX_CP_GAIN	MAIN_R[17]	Aux Charge Pump Current Gain	LOW	HIGH
MAIN_CP_GAIN	MAIN_R[16]	Main Charge Pump Current Gain	LOW	HIGH
AUX_PD_POL	MAIN_R[15]	Aux Phase Detector Polarity	Negative	Positive
MAIN_PD_POL	MAIN_R[14]	Main Phase Detector Polarity	Negative	Positive

AUX_CP_GAIN (MAIN_R[17]) and MAIN_CP_GAIN (MAIN_R[16]) are used to select charge pump current magnitude either low gain mode (160 μA typ) or high gain mode (1600 μA typ)

AUX_PD_POL (MAIN_R[15]) and MAIN_PD_POL (MAIN_R[14]) are respectively set to one when Aux or Main VCO characteristics are positive as in (1) below. When VCO frequency decreases with increasing control voltage (2) PD_POL should set to zero.

2.0 Programming Description (Continued)

2.4.1 VCO Characteristics

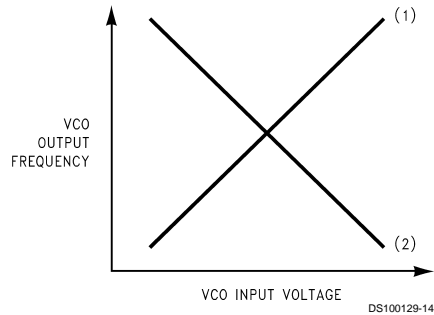

2.4.2 Phase Comparator and Internal Charge Pump Characteristics (AUX_PD_POL/MAIN_PD_POL = 1)

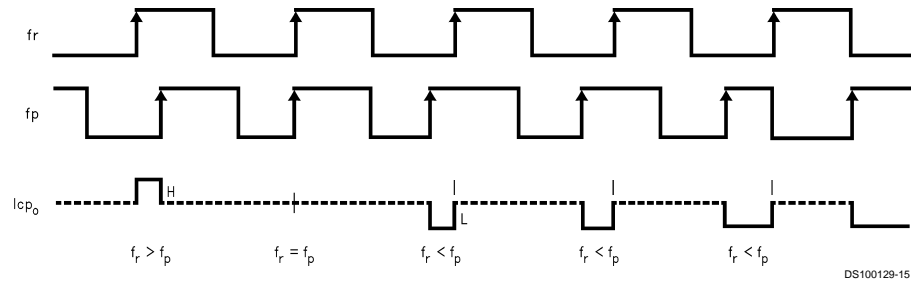

Note 15: f_r is phase detector input from reference counter. f_p is phase detector input from programmable N counter.
Phase difference detection range: -2π to $+2\pi$.
The minimum width pump up and pump down current pulses occur at the CP0 pin when the loop is locked.

2.5 F_{OUT}/LOCK DETECT PROGRAMMING TRUTH TABLE (FoLD)

FoLD				Fo/LD OUTPUT STATE
3	2	1	0	
AUX_R[17]	AUX_R[16]	AUX_R[15]	AUX_R[14]	
0	0	0	0	"0"
0	0	0	1	"1"
0	0	1	X	Main Lock Detect
0	1	0	x	Aux Lock Detect
0	1	1	X	Main "and" Aux Lock Detect
1	0	0	X	Main Reference Counter Output
1	0	1	X	Aux Reference Counter Output
1	1	0	X	Main Programmable Counter Output
1	1	1	X	Aux Programmable Counter Output

Note 16: See section 2.5.3 for AUX_R[14] description.

2.0 Programming Description (Continued)

2.5.1 Lock Detect Digital Filter

The Lock Detect Digital Filter compares the difference between the phase of the inputs of the phase detector to a RC generated delay of approximately 15 ns. To enter the locked state (Lock = HIGH) the phase error must be less than the 15 ns RC delay for 4 consecutive reference cycles. Once in lock (Lock = HIGH), the RC delay is changed to approximately 30 ns. To exit the locked state (Lock = LOW), the phase error must become greater than the 30 ns RC delay. When the PLL is in the powerdown mode, Lock is forced LOW. A flow chart of the digital filter is shown below.

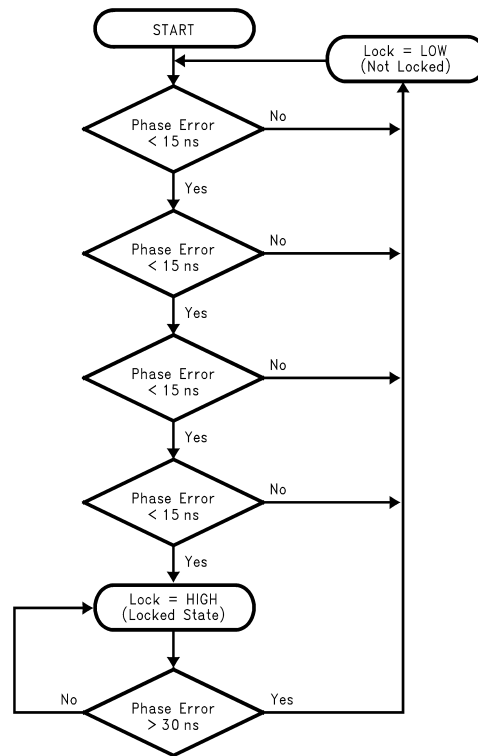

DS100129-16

2.5.2 Typical Lock Detect Timing (AUX_PD_POL/MAIN_PD_POL = 1)

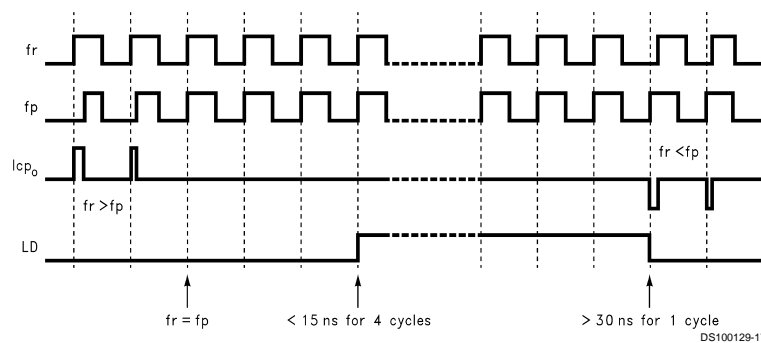

DS100129-17

2.0 Programming Description (Continued)

2.5.3 OSC Mode Programming

The OSC_{OUT} pin can be optimized for operating with an external crystal resonator or an external reference frequency source (i.e. TCXO). If the application uses an external reference frequency source, the current dissipation of the LMX1600/01/02 can be reduced with the Logic Mode (0.5 mA typ.). Crystal Mode should be used when an external crystal resonator is used. Logic Mode is used when an external reference frequency source is used. In Logic Mode, OSC_{OUT} should be connected to a 30 pF capacitor to ground for optimum performance.

When the FoLD output state is selected to CMOS high/low levels, the OSC Mode is forced to Crystal Mode.

FoLD				OSC _{OUT}	
3	2	1	0		
AUX_R[17]	AUX_R[16]	AUX_R[15]	AUX_R[14]		
0	0	0	0	Crystal Mode	
0	0	0	1	Crystal Mode	
All Other States				0	Logic Mode
				1	Crystal Mode

2.5.4 Typical Crystal Oscillator Circuit

A typical implementation of a 10 MHz crystal oscillator with the OSC_{OUT} pin in Crystal Mode is shown below.

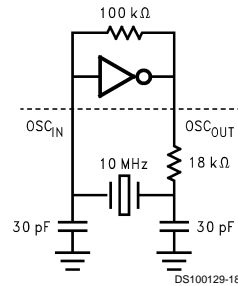

2.6 SERIAL DATA INPUT TIMING

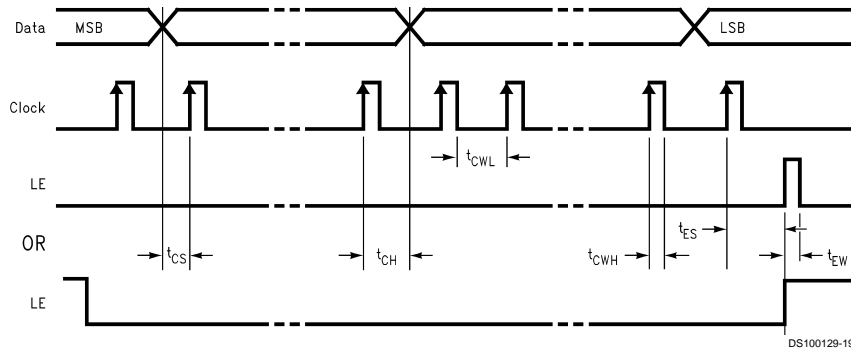

Note 17: Data shifted into register on clock rising edge.
Data is shifted in MSB first.

TEST CONDITIONS: The Serial Data Input Timing is tested using a symmetrical waveform around $V_{CC}/2$. The test waveform has an edge rate of 0.6 V/ns with amplitudes of 2.2V @ $V_{CC} = 2.7V$.

Physical Dimensions inches (millimeters) unless otherwise noted

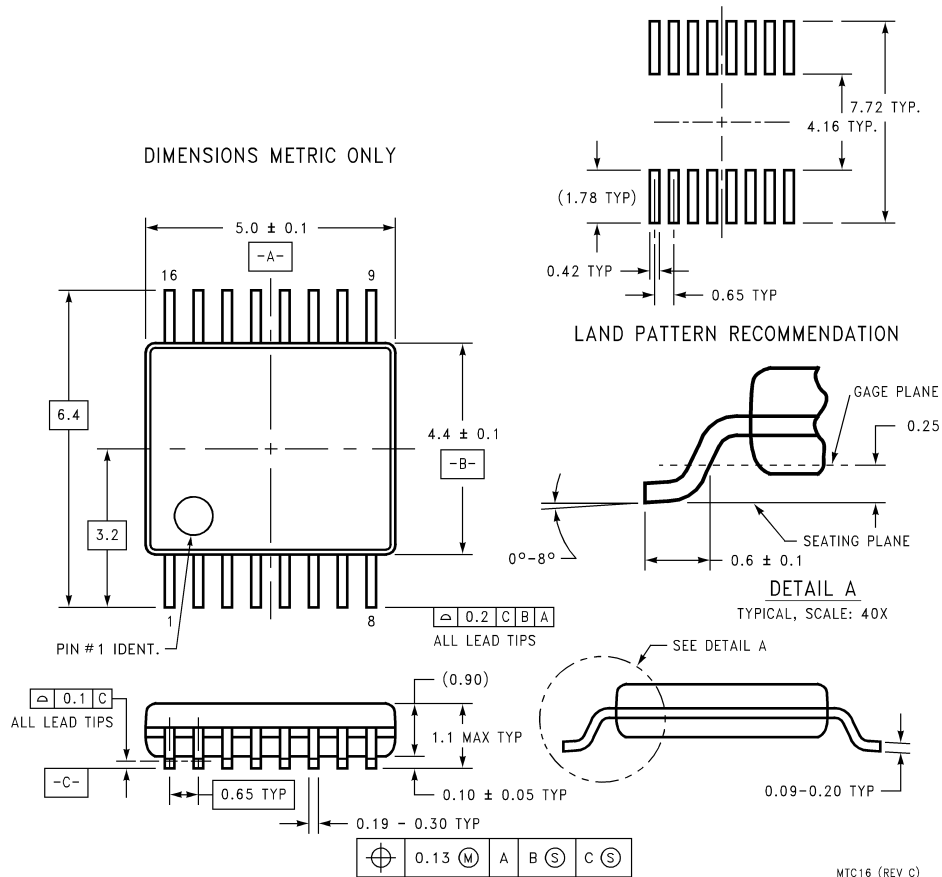

Dimensions are in millimeters.

LMX1600/01/02 Frequency Synthesizer IC (16-Pin TSSOP Package)
NS Package Number MTC16

LIFE SUPPORT POLICY

NATIONAL'S PRODUCTS ARE NOT AUTHORIZED FOR USE AS CRITICAL COMPONENTS IN LIFE SUPPORT DEVICES OR SYSTEMS WITHOUT THE EXPRESS WRITTEN APPROVAL OF THE PRESIDENT OF NATIONAL SEMICONDUCTOR CORPORATION. As used herein:

1. Life support devices or systems are devices or systems which, (a) are intended for surgical implant into the body, or (b) support or sustain life, and whose failure to perform when properly used in accordance with instructions for use provided in the labeling, can be reasonably expected to result in a significant injury to the user.
2. A critical component in any component of a life support device or system whose failure to perform can be reasonably expected to cause the failure of the life support device or system, or to affect its safety or effectiveness.



National Semiconductor Corporation
Americas
Tel: 1-800-272-9959
Fax: 1-800-737-7018
Email: support@nsc.com

National Semiconductor Europe
Fax: +49 (0) 1 80-530 85 86
Email: europe.support@nsc.com
Deutsch Tel: +49 (0) 1 80-530 85 85
English Tel: +49 (0) 1 80-532 78 32
Français Tel: +49 (0) 1 80-532 93 58
Italiano Tel: +49 (0) 1 80-534 16 80

National Semiconductor Asia Pacific Customer Response Group
Tel: 65-2544466
Fax: 65-2504466
Email: sea.support@nsc.com

National Semiconductor Japan Ltd.
Tel: 81-3-5620-6175
Fax: 81-3-5620-6179

www.national.com

National does not assume any responsibility for use of any circuitry described, no circuit patent licenses are implied and National reserves the right at any time without notice to change said circuitry and specifications.