

# MC74VHCT126A

## Quad Bus Buffer with 3-State Control Inputs

The MC74VHCT126A is a high speed CMOS quad bus buffer fabricated with silicon gate CMOS technology. It achieves noninverting high speed operation similar to equivalent Bipolar Schottky TTL while maintaining CMOS low power dissipation.

The MC74VHCT126A requires the 3-state control input (OE) to be set Low to place the output into high impedance.

The VHCT inputs are compatible with TTL levels. This device can be used as a level converter for interfacing 3.3V to 5.0V, because it has full 5V CMOS level output swings.

The VHCT126A input structures provide protection when voltages between 0V and 5.5V are applied, regardless of the supply voltage. The output structures also provide protection when  $V_{CC} = 0V$ . These input and output structures help prevent device destruction caused by supply voltage – input/output voltage mismatch, battery backup, hot insertion, etc.

The internal circuit is composed of three stages, including a buffer output which provides high noise immunity and stable output. The inputs tolerate voltages up to 7V, allowing the interface of 5V systems to 3V systems.

- High Speed:  $t_{PD} = 3.8ns$  (Typ) at  $V_{CC} = 5V$
- Low Power Dissipation:  $I_{CC} = 4\mu A$  (Max) at  $T_A = 25^\circ C$
- TTL-Compatible Inputs:  $V_{IL} = 0.8V$ ;  $V_{IH} = 2.0V$
- Power Down Protection Provided on Inputs
- Balanced Propagation Delays
- Designed for 2V to 5.5V Operating Range
- Low Noise:  $V_{OLP} = 0.8V$  (Max)
- Pin and Function Compatible with Other Standard Logic Families
- Latchup Performance Exceeds 300mA
- ESD Performance: HBM > 2000V; Machine Model > 200V
- Chip Complexity: 72 FETs or 18 Equivalent Gates

### LOGIC DIAGRAM

#### Active-High Output Enables

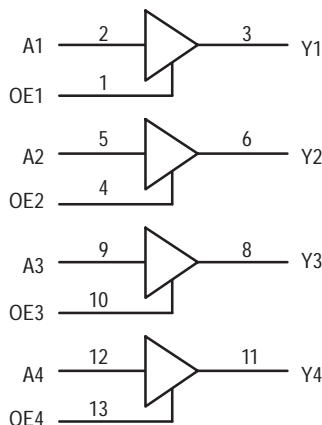

### FUNCTION TABLE

VHCT126A		
Inputs		Output
A	OE	Y
H	H	H
L	H	L
X	L	Z



ON Semiconductor

<http://onsemi.com>

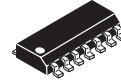

14-LEAD SOIC  
D SUFFIX  
CASE 751A

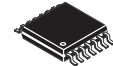

14-LEAD TSSOP  
DT SUFFIX  
CASE 948G

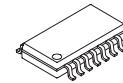

14-LEAD SOIC EIAJ  
M SUFFIX  
CASE 965

### PIN CONNECTION AND MARKING DIAGRAM (Top View)

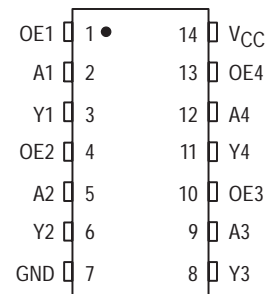

For detailed package marking information, see the Marking Diagram section on page 4 of this data sheet.

### ORDERING INFORMATION

Device	Package	Shipping
MC74VHCT126AD	SOIC	55 Units/Rail
MC74VHCT126ADT	TSSOP	96 Units/Rail
MC74VHCT126AM	SOIC EIAJ	50 Units/Rail

# MC74VHCT126A

## MAXIMUM RATINGS\*

Symbol	Parameter	Value	Unit
V <sub>CC</sub>	DC Supply Voltage	- 0.5 to + 7.0	V
V <sub>in</sub>	DC Input Voltage	- 0.5 to + 7.0	V
V <sub>out</sub>	DC Output Voltage	- 0.5 to V <sub>CC</sub> + 0.5	V
I <sub>IK</sub>	Input Diode Current	- 20	mA
I <sub>OK</sub>	Output Diode Current	± 20	mA
I <sub>out</sub>	DC Output Current, per Pin	± 25	mA
I <sub>CC</sub>	DC Supply Current, V <sub>CC</sub> and GND Pins	± 50	mA
P <sub>D</sub>	Power Dissipation in Still Air, SOIC Packages† TSSOP Package†	500 450	mW
T <sub>stg</sub>	Storage Temperature	- 65 to + 150	°C

This device contains protection circuitry to guard against damage due to high static voltages or electric fields. However, precautions must be taken to avoid applications of any voltage higher than maximum rated voltages to this high-impedance circuit. For proper operation, V<sub>in</sub> and V<sub>out</sub> should be constrained to the range GND ≤ (V<sub>in</sub> or V<sub>out</sub>) ≤ V<sub>CC</sub>. Unused inputs must always be tied to an appropriate logic voltage level (e.g., either GND or V<sub>CC</sub>). Unused outputs must be left open.

\* Absolute maximum continuous ratings are those values beyond which damage to the device may occur. Exposure to these conditions or conditions beyond those indicated may adversely affect device reliability. Functional operation under absolute-maximum-rated conditions is not implied.

† Derating — SOIC Packages: - 7 mW/°C from 65° to 125°C  
TSSOP Package: - 6.1 mW/°C from 65° to 125°C

## RECOMMENDED OPERATING CONDITIONS

Symbol	Parameter	Min	Max	Unit
V <sub>CC</sub>	DC Supply Voltage	4.5	5.5	V
V <sub>in</sub>	DC Input Voltage	0	5.5	V
V <sub>out</sub>	DC Output Voltage	0	V <sub>CC</sub>	V
T <sub>A</sub>	Operating Temperature, All Package Types	- 40	+ 85	°C
t <sub>r</sub> , t <sub>f</sub>	Input Rise and Fall Time V <sub>CC</sub> = 5.0V ± 0.5V	0	20	ns/V

## DC ELECTRICAL CHARACTERISTICS

Symbol	Parameter	Test Conditions	V <sub>CC</sub> (V)	T <sub>A</sub> = 25°C			T <sub>A</sub> ≤ 85°C		T <sub>A</sub> ≤ 125°C		Unit
				Min	Typ	Max	Min	Max	Min	Max	
V <sub>IH</sub>	Minimum High-Level Input Voltage		3.0	1.2			1.2		1.2		V
			4.5	2.0		2.0		2.0			
			5.5	2.0		2.0		2.0			
V <sub>IL</sub>	Maximum Low-Level Input Voltage		3.0			0.53		0.53		0.53	V
			4.5			0.8		0.8		0.8	
			5.5			0.8		0.8		0.8	
V <sub>OH</sub>	Minimum High-Level Output Voltage V <sub>IN</sub> = V <sub>IH</sub> or V <sub>IL</sub>	V <sub>IN</sub> = V <sub>IH</sub> or V <sub>IL</sub> I <sub>OH</sub> = - 50μA	3.0	2.9	3.0		2.9		2.9		V
		4.5	4.4	4.5		4.4		4.4			
		V <sub>IN</sub> = V <sub>IH</sub> or V <sub>IL</sub> I <sub>OH</sub> = - 4mA	3.0	2.58			2.48		2.34		
		4.5	3.94			3.80		3.66			
V <sub>OL</sub>	Maximum Low-Level Output Voltage V <sub>IN</sub> = V <sub>IH</sub> or V <sub>IL</sub>	V <sub>IN</sub> = V <sub>IH</sub> or V <sub>IL</sub> I <sub>OL</sub> = 50μA	3.0		0.0	0.1		0.1		0.1	V
		4.5		0.0	0.1		0.1		0.1		
		V <sub>IN</sub> = V <sub>IH</sub> or V <sub>IL</sub> I <sub>OL</sub> = 4mA	3.0			0.36		0.44		0.52	
		4.5			0.36		0.44		0.52		
I <sub>IN</sub>	Maximum Input Leakage Current	V <sub>IN</sub> = 5.5 V or GND	0 to 5.5			± 0.1		± 1.0		μA	
I <sub>CC</sub>	Maximum Quiescent Supply Current	V <sub>IN</sub> = V <sub>CC</sub> or GND	5.5			2.0		20		40	μA
I <sub>CC(T)</sub>	Quiescent Supply Current	Input: V <sub>IN</sub> = 3.4V	5.5			1.35		1.50		1.65	mA
I <sub>OPD</sub>	Output Leakage Current	V <sub>OUT</sub> = 5.5V	0.0			0.5		5.0		10	μA

# MC74VHCT126A

## AC ELECTRICAL CHARACTERISTICS (Input $t_r = t_f = 3.0\text{ns}$ )

Symbol	Parameter	Test Conditions	$T_A = 25^\circ\text{C}$			$T_A = \leq 85^\circ\text{C}$		$T_A \leq 125^\circ\text{C}$		Unit
			Min	Typ	Max	Min	Max	Min	Max	
$t_{PLH}$ , $t_{PHL}$	Maximum Propagation Delay, A to Y	$V_{CC} = 3.3 \pm 0.3\text{V}$ $C_L = 15\text{pF}$		5.6	8.0	1.0	9.5		12.0	ns
		$C_L = 50\text{pF}$		8.1	11.5	1.0	13.0		16.0	
		$V_{CC} = 5.0 \pm 0.5\text{V}$ $C_L = 15\text{pF}$		3.8	5.5	1.0	6.5		8.5	
		$C_L = 50\text{pF}$		5.3	7.5	1.0	8.5		10.5	
$t_{PZL}$ , $t_{PZH}$	Maximum Output Enable Time, $\overline{OE}$ to Y	$V_{CC} = 3.3 \pm 0.3\text{V}$ $C_L = 15\text{pF}$		5.4	8.0	1.0	9.5		11.5	ns
		$R_L = 1\text{k}\Omega$ $C_L = 50\text{pF}$		7.9	11.5	1.0	13.0		15.0	
		$V_{CC} = 5.0 \pm 0.5\text{V}$ $C_L = 15\text{pF}$		3.6	5.1	1.0	6.0		7.5	
		$R_L = 1\text{k}\Omega$ $C_L = 50\text{pF}$		5.1	7.1	1.0	8.0		9.5	
$t_{PLZ}$ , $t_{PHZ}$	Maximum Output Disable Time, $\overline{OE}$ to Y	$V_{CC} = 3.3 \pm 0.3\text{V}$ $C_L = 50\text{pF}$		9.5	13.2	1.0	15.0		18.0	ns
		$R_L = 1\text{k}\Omega$								
		$V_{CC} = 5.0 \pm 0.5\text{V}$ $C_L = 50\text{pF}$		6.1	8.8	1.0	10.0		12.0	
		$R_L = 1\text{k}\Omega$								
$t_{OSLH}$ , $t_{OSHL}$	Output-to-Output Skew	$V_{CC} = 3.3 \pm 0.3\text{V}$ $C_L = 50\text{pF}$ (Note 1.)			1.5		1.5		2.0	ns
		$V_{CC} = 5.0 \pm 0.5\text{V}$ $C_L = 50\text{pF}$ (Note 1.)			1.0		1.0		1.5	
$C_{in}$	Maximum Input Capacitance			4	10		10		10	pF
$C_{out}$	Maximum Three-State Output Capacitance (Output in High Impedance State)			6						pF

$C_{PD}$	Power Dissipation Capacitance (Note 2.)	Typical @ $25^\circ\text{C}$ , $V_{CC} = 5.0\text{V}$		pF
			15	

- Parameter guaranteed by design.  $t_{OSLH} = |t_{PLHm} - t_{PLHn}|$ ,  $t_{OSHL} = |t_{PHLm} - t_{PHLn}|$ .
- $C_{PD}$  is defined as the value of the internal equivalent capacitance which is calculated from the operating current consumption without load. Average operating current can be obtained by the equation:  $I_{CC(OPR)} = C_{PD} \cdot V_{CC} \cdot f_{in} + I_{CC}/4$  (per buffer).  $C_{PD}$  is used to determine the no-load dynamic power consumption;  $P_D = C_{PD} \cdot V_{CC}^2 \cdot f_{in} + I_{CC} \cdot V_{CC}$ .

## NOISE CHARACTERISTICS (Input $t_r = t_f = 3.0\text{ns}$ , $C_L = 50\text{pF}$ , $V_{CC} = 5.0\text{V}$ )

Symbol	Characteristic	$T_A = 25^\circ\text{C}$		Unit
		Typ	Max	
$V_{OLP}$	Quiet Output Maximum Dynamic $V_{OL}$	0.3	0.8	V
$V_{OLV}$	Quiet Output Minimum Dynamic $V_{OL}$	-0.3	-0.8	V
$V_{IHD}$	Minimum High Level Dynamic Input Voltage		3.5	V
$V_{ILD}$	Maximum Low Level Dynamic Input Voltage		1.5	V

# MC74VHCT126A

## SWITCHING WAVEFORMS

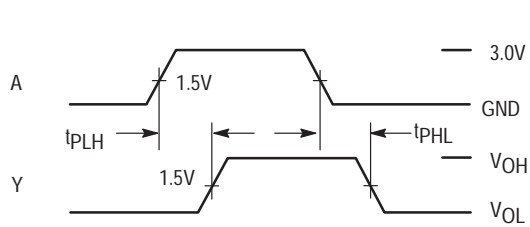

Figure 1.

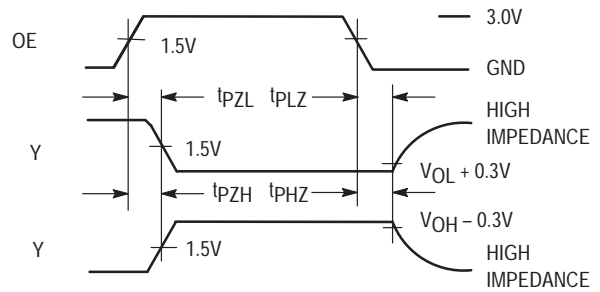
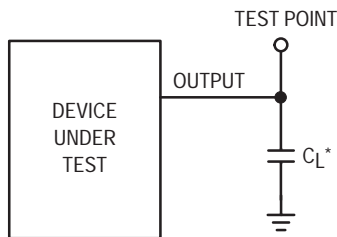
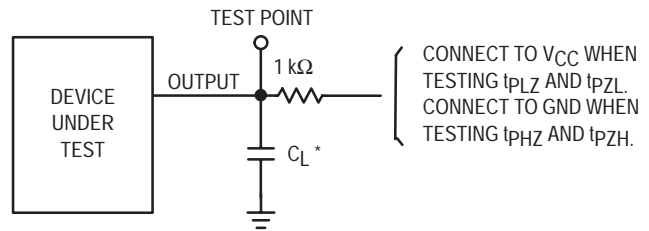

Figure 2.



\*Includes all probe and jig capacitance

Figure 3. Test Circuit



\*Includes all probe and jig capacitance

Figure 4. Test Circuit

## MARKING DIAGRAMS

(Top View)

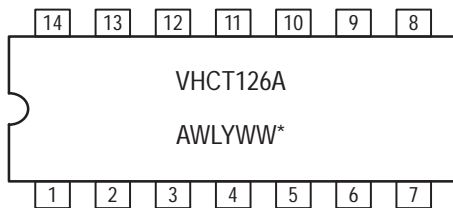

14-LEAD SOIC  
D SUFFIX  
CASE 751A

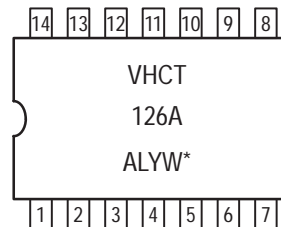

14-LEAD TSSOP  
DT SUFFIX  
CASE 948G

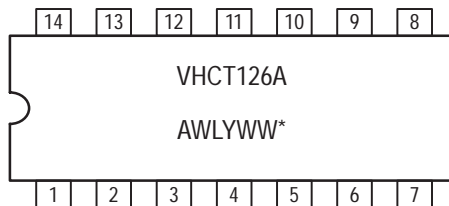

14-LEAD SOIC EIAJ  
M SUFFIX  
CASE 965

\*See Applications Note #AND8004/D for date code and traceability information.

# MC74VHCT126A

## PACKAGE DIMENSIONS

**D SUFFIX**  
**PLASTIC SOIC PACKAGE**  
 CASE 751A-03  
 ISSUE F

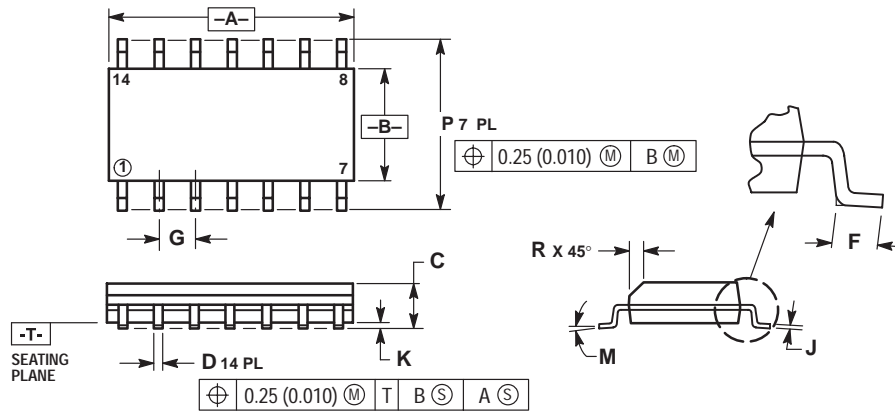

**NOTES:**

1. DIMENSIONING AND TOLERANCING PER ANSI Y14.5M, 1982.
2. CONTROLLING DIMENSION: MILLIMETER.
3. DIMENSIONS A AND B DO NOT INCLUDE MOLD PROTRUSION.
4. MAXIMUM MOLD PROTRUSION 0.15 (0.006) PER SIDE.
5. DIMENSION D DOES NOT INCLUDE DAMBAR PROTRUSION. ALLOWABLE DAMBAR PROTRUSION SHALL BE 0.127 (0.005) TOTAL IN EXCESS OF THE D DIMENSION AT MAXIMUM MATERIAL CONDITION.

DIM	MILLIMETERS		INCHES	
	MIN	MAX	MIN	MAX
A	8.55	8.75	0.337	0.344
B	3.80	4.00	0.150	0.157
C	1.35	1.75	0.054	0.068
D	0.35	0.49	0.014	0.019
F	0.40	1.25	0.016	0.049
G	1.27 BSC		0.050 BSC	
J	0.19	0.25	0.008	0.009
K	0.10	0.25	0.004	0.009
M	0°	7°	0°	7°
P	5.80	6.20	0.228	0.244
R	0.25	0.50	0.010	0.019

# MC74VHCT126A

## PACKAGE DIMENSIONS

DT SUFFIX  
 PLASTIC TSSOP PACKAGE  
 CASE 948G-01  
 ISSUE O

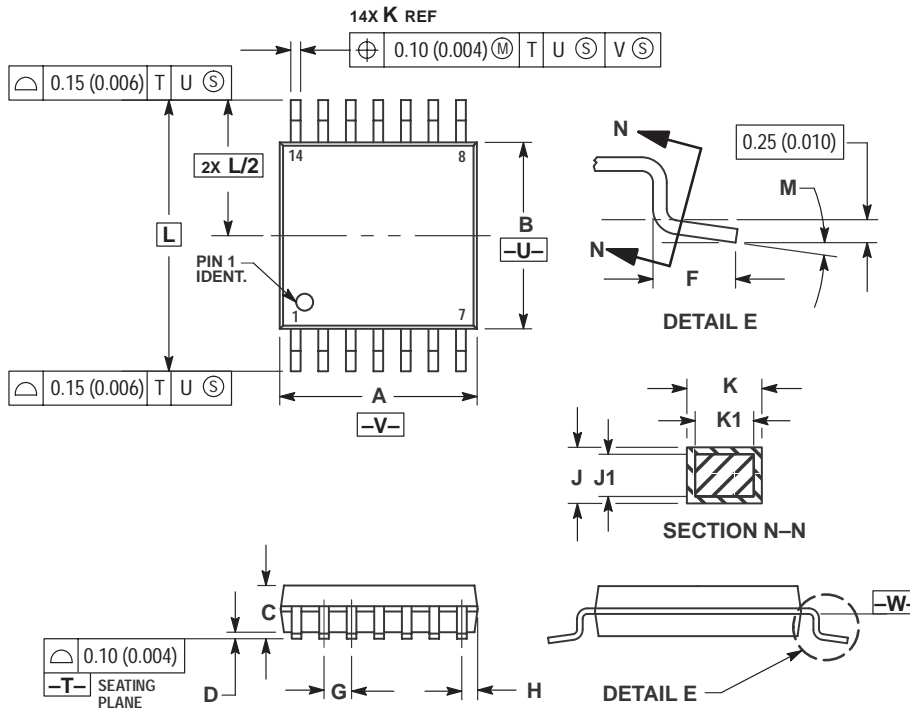

### NOTES:

1. DIMENSIONING AND TOLERANCING PER ANSI Y14.5M, 1982.
2. CONTROLLING DIMENSION: MILLIMETER.
3. DIMENSION A DOES NOT INCLUDE MOLD FLASH, PROTRUSIONS OR GATE BURRS. MOLD FLASH OR GATE BURRS SHALL NOT EXCEED 0.15 (0.006) PER SIDE.
4. DIMENSION B DOES NOT INCLUDE INTERLEAD FLASH OR PROTRUSION. INTERLEAD FLASH OR PROTRUSION SHALL NOT EXCEED 0.25 (0.010) PER SIDE.
5. DIMENSION K DOES NOT INCLUDE DAMBAR PROTRUSION. ALLOWABLE DAMBAR PROTRUSION SHALL BE 0.08 (0.003) TOTAL IN EXCESS OF THE K DIMENSION AT MAXIMUM MATERIAL CONDITION.
6. TERMINAL NUMBERS ARE SHOWN FOR REFERENCE ONLY.
7. DIMENSION A AND B ARE TO BE DETERMINED AT DATUM PLANE -W-.

DIM	MILLIMETERS		INCHES	
	MIN	MAX	MIN	MAX
A	4.90	5.10	0.193	0.200
B	4.30	4.50	0.169	0.177
C	---	1.20	---	0.047
D	0.05	0.15	0.002	0.006
F	0.50	0.75	0.020	0.030
G	0.65 BSC		0.026 BSC	
H	0.50	0.60	0.020	0.024
J	0.09	0.20	0.004	0.008
J1	0.09	0.16	0.004	0.006
K	0.19	0.30	0.007	0.012
K1	0.19	0.25	0.007	0.010
L	6.40 BSC		0.252 BSC	
M	0°	8°	0°	8°

# MC74VHCT126A

## PACKAGE DIMENSIONS

**M SUFFIX**  
 PLASTIC SOIC EIAJ PACKAGE  
 CASE 965-01  
 ISSUE O

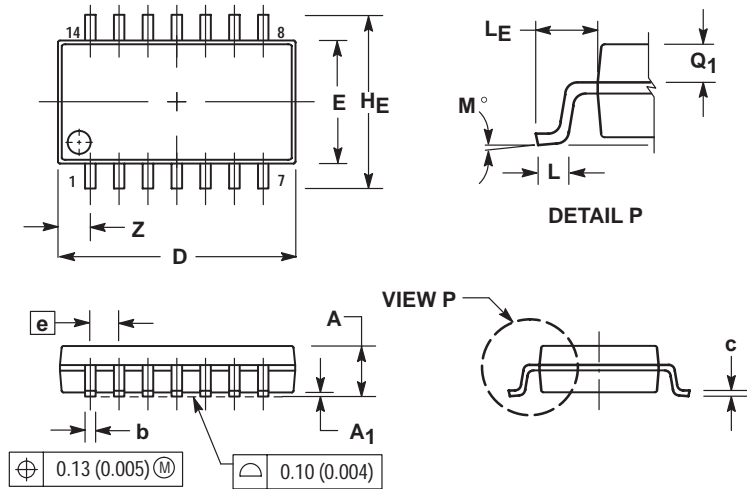

**NOTES:**

1. DIMENSIONING AND TOLERANCING PER ANSI Y14.5M, 1982.
2. CONTROLLING DIMENSION: MILLIMETER.
3. DIMENSIONS D AND E DO NOT INCLUDE MOLD FLASH OR PROTRUSIONS AND ARE MEASURED AT THE PARTING LINE. MOLD FLASH OR PROTRUSIONS SHALL NOT EXCEED 0.15 (0.006) PER SIDE.
4. TERMINAL NUMBERS ARE SHOWN FOR REFERENCE ONLY.
5. THE LEAD WIDTH DIMENSION (b) DOES NOT INCLUDE DAMBAR PROTRUSION. ALLOWABLE DAMBAR PROTRUSION SHALL BE 0.08 (0.003) TOTAL IN EXCESS OF THE LEAD WIDTH DIMENSION AT MAXIMUM MATERIAL CONDITION. DAMBAR CANNOT BE LOCATED ON THE LOWER RADIUS OR THE FOOT. MINIMUM SPACE BETWEEN PROTRUSIONS AND ADJACENT LEAD TO BE 0.46 (0.018).

DIM	MILLIMETERS		INCHES	
	MIN	MAX	MIN	MAX
A	---	2.05	---	0.081
A <sub>1</sub>	0.05	0.20	0.002	0.008
b	0.35	0.50	0.014	0.020
c	0.18	0.27	0.007	0.011
D	9.90	10.50	0.390	0.413
E	5.10	5.45	0.201	0.215
e	1.27 BSC		0.050 BSC	
HE	7.40	8.20	0.291	0.323
0.50	0.50	0.85	0.020	0.033
LE	1.10	1.50	0.043	0.059
M	0°	10°	0°	10°
Q <sub>1</sub>	0.70	0.90	0.028	0.035
Z	---	1.42	---	0.056

**ON Semiconductor** and  are trademarks of Semiconductor Components Industries, LLC (SCILLC). SCILLC reserves the right to make changes without further notice to any products herein. SCILLC makes no warranty, representation or guarantee regarding the suitability of its products for any particular purpose, nor does SCILLC assume any liability arising out of the application or use of any product or circuit, and specifically disclaims any and all liability, including without limitation special, consequential or incidental damages. "Typical" parameters which may be provided in SCILLC data sheets and/or specifications can and do vary in different applications and actual performance may vary over time. All operating parameters, including "Typicals" must be validated for each customer application by customer's technical experts. SCILLC does not convey any license under its patent rights nor the rights of others. SCILLC products are not designed, intended, or authorized for use as components in systems intended for surgical implant into the body, or other applications intended to support or sustain life, or for any other application in which the failure of the SCILLC product could create a situation where personal injury or death may occur. Should Buyer purchase or use SCILLC products for any such unintended or unauthorized application, Buyer shall indemnify and hold SCILLC and its officers, employees, subsidiaries, affiliates, and distributors harmless against all claims, costs, damages, and expenses, and reasonable attorney fees arising out of, directly or indirectly, any claim of personal injury or death associated with such unintended or unauthorized use, even if such claim alleges that SCILLC was negligent regarding the design or manufacture of the part. SCILLC is an Equal Opportunity/Affirmative Action Employer.

## PUBLICATION ORDERING INFORMATION

### **NORTH AMERICA Literature Fulfillment:**

Literature Distribution Center for ON Semiconductor  
P.O. Box 5163, Denver, Colorado 80217 USA  
**Phone:** 303-675-2175 or 800-344-3860 Toll Free USA/Canada  
**Fax:** 303-675-2176 or 800-344-3867 Toll Free USA/Canada  
**Email:** ONlit@hibbertco.com  
Fax Response Line: 303-675-2167 or 800-344-3810 Toll Free USA/Canada

**N. American Technical Support:** 800-282-9855 Toll Free USA/Canada

**EUROPE:** LDC for ON Semiconductor – European Support

**German Phone:** (+1) 303-308-7140 (M-F 1:00pm to 5:00pm Munich Time)  
**Email:** ONlit-german@hibbertco.com  
**French Phone:** (+1) 303-308-7141 (M-F 1:00pm to 5:00pm Toulouse Time)  
**Email:** ONlit-french@hibbertco.com  
**English Phone:** (+1) 303-308-7142 (M-F 12:00pm to 5:00pm UK Time)  
**Email:** ONlit@hibbertco.com

**EUROPEAN TOLL-FREE ACCESS\*: 00-800-4422-3781**

\*Available from Germany, France, Italy, England, Ireland

### **CENTRAL/SOUTH AMERICA:**

**Spanish Phone:** 303-308-7143 (Mon-Fri 8:00am to 5:00pm MST)  
**Email:** ONlit-spanish@hibbertco.com

**ASIA/PACIFIC:** LDC for ON Semiconductor – Asia Support

**Phone:** 303-675-2121 (Tue-Fri 9:00am to 1:00pm, Hong Kong Time)  
Toll Free from Hong Kong & Singapore:  
**001-800-4422-3781**  
**Email:** ONlit-asia@hibbertco.com

**JAPAN:** ON Semiconductor, Japan Customer Focus Center  
4-32-1 Nishi-Gotanda, Shinagawa-ku, Tokyo, Japan 141-8549

**Phone:** 81-3-5740-2745  
**Email:** r14525@onsemi.com

**ON Semiconductor Website:** <http://onsemi.com>

For additional information, please contact your local Sales Representative.