

LM4897 Boomer® Audio Power Amplifier Series

1.1 Watt Audio Power Amplifier with Fade-In and Fade-Out

General Description

The LM4897 is an audio power amplifier primarily designed for demanding applications in mobile phones and other portable communication device applications. It is capable of delivering 1.1W of continuous average power to an 8Ω BTL load with less than 1% distortion (THD+N) from a +5V_{DC} power supply.

The LM4897 contains advanced pop and click circuitry that eliminate noises which would otherwise occur during turn-on and turn-off transitions. It also contains a fade-in/fade-out feature that eliminates unnatural sound generated by asserting/de-asserting the SHUTDOWN pin. The LM4897 is unity-gain stable and can be configured by external gain-setting resistors.

The LM4897 features a low-power consumption global shutdown mode, which is achieved by driving the shutdown pin with logic low. Additionally, the LM4897 features an internal thermal shutdown protection mechanism.

Boomer audio power amplifiers were designed specifically to provide high quality output power with a minimal amount of external components. The LM4897 does not require output coupling capacitors or bootstrap capacitors, and therefore is ideally suited for lower-power portable applications where minimal space and power consumption are primary requirements.

Key Specifications

- Improved PSRR at 5V, 3V, & 217Hz 62dB (typ)
- Higher P_O at 5V, THD+N = 1% 1.1W (typ)
- Higher P_O at 3V, THD+N = 1% 350mW (typ)
- Shutdown Current 0.1μA (typ)

Features

- No output coupling capacitors, snubber networks or bootstrap capacitors required
- Unity gain stable
- Ultra low current shutdown mode
- Fade-In/Fade-Out
- BTL output can drive capacitive loads up to 100pF
- Advanced pop and click circuitry eliminates noises during turn-on and turn-off transitions
- 2.6V - 5.5V operation
- Available in a space-saving SO package

Applications

- Mobile Phones
- PDAs
- Portable electronic devices

Connection Diagrams

Mini Small Outline (MSOP) Package

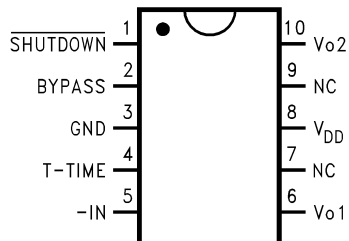

Top View
Order Number LM4897MM
See NS package Number MUB10A

MSOP Marking

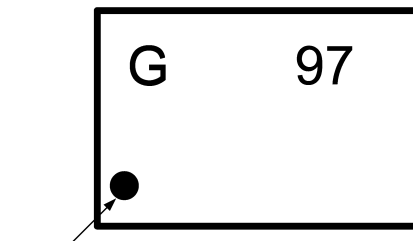

Top View
G - Boomer Family
97 - LM4897MM

Boomer® is a registered trademark of National Semiconductor Corporation.

Typical Application

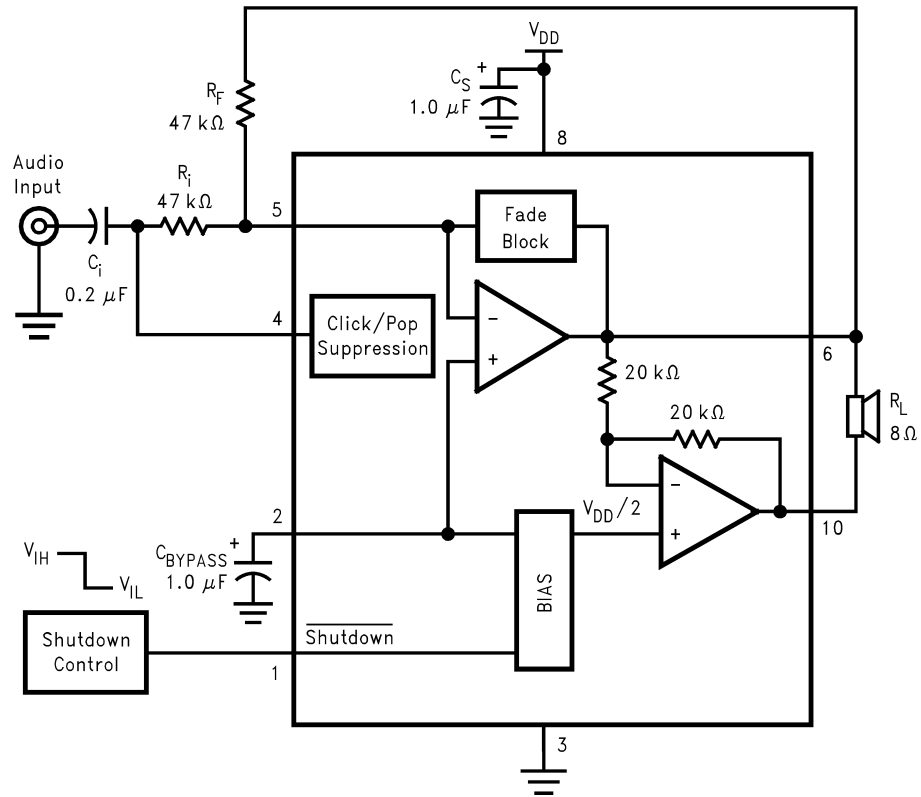

20050901

FIGURE 1. Typical Audio Amplifier Application Circuit

Absolute Maximum Ratings (Note 2)

If Military/Aerospace specified devices are required, please contact the National Semiconductor Sales Office/Distributors for availability and specifications.

Supply Voltage	6.0V
Storage Temperature	-65°C to +150°C
Input Voltage	-0.3V to $V_{DD} + 0.3V$
Power Dissipation (Note 3)	Internally Limited
ESD Susceptibility (Note 4)	2000V
ESD Susceptibility (Note 5)	200V

Junction Temperature	150°C
Thermal Resistance	
θ_{JC} (MUB10A)	56°C/W
θ_{JA} (MUB10A)	190°C/W

Operating Ratings

Temperature Range	$-40^{\circ}\text{C} \leq T_A \leq 85^{\circ}\text{C}$
Supply Voltage	$2.6V \leq V_{DD} \leq 5.5V$
$T_{MIN} \leq T_A \leq T_{MAX}$	

Electrical Characteristics $V_{DD} = 5.0V$ (Notes 1, 2)

The following specifications apply for the circuit shown in *Figure 1* unless otherwise specified. Limits apply for $T_A = 25^{\circ}\text{C}$.

Symbol	Parameter	Conditions	LM4897		Units (Limits)
			Typical	Limit	
			(Note 6)	(Notes 7, 8)	
I_{DD}	Quiescent Power Supply Current	$V_{IN} = 0V, 8\Omega$ BTL	5	9	mA (max)
I_{SD}	Shutdown Current	$V_{shutdown} = GND$	0.1	2	μA (max)
V_{OS}	Output Offset Voltage		4	30	mV (max)
P_o	Output Power	THD+N = 1% (max), $f = 1\text{kHz}$	1.1	0.9	W (min)
THD+N	Total Harmonic Distortion+Noise	$P_o = 0.4W_{rms}, f = 1\text{kHz}$	0.1		%
PSRR	Power Supply Rejection Ratio	$V_{ripple} = 200mV_{pp}$ sine wave, $C_B = 1.0\mu\text{F}$ Input terminated with 10Ω to GND	63 ($f = 1\text{kHz}$) 62 ($f = 217\text{Hz}$)	55 55	dB (min)
V_{SDIH}	Shutdown High Input Voltage			1.4	V (min)
V_{SDIL}	Shutdown Low Input Voltage			0.4	V (max)
V_{ON}	Output Noise	A-Weighted, Measured across 8Ω BTL Input terminated with 10Ω to ground	26		μV_{RMS}
T_{ON}	Turn-On Time	$C_{BYPASS} = 1\mu\text{F}$	25	35	ms (max)

Electrical Characteristics $V_{DD} = 3.0V$ (Notes 1, 2)

The following specifications apply for the circuit shown in *Figure 1* unless otherwise specified. Limits apply for $T_A = 25^{\circ}\text{C}$.

Symbol	Parameter	Conditions	LM4897		Units (Limits)
			Typical	Limit	
			(Note 6)	(Notes 7, 8)	
I_{DD}	Quiescent Power Supply Current	$V_{IN} = 0V, 8\Omega$ BTL	4	8	mA (max)
I_{SD}	Shutdown Current	$V_{shutdown} = GND$	0.1	2	μA (max)
P_o	Output Power	THD+N = 1% (max), $f = 1\text{kHz}$	350	320	mW (min)
V_{OS}	Output Offset Voltage		4	30	mV (max)
THD+N	Total Harmonic Distortion+Noise	$P_o = 0.15W_{rms}, f = 1\text{kHz}$	0.1		%
PSRR	Power Supply Rejection Ratio	$V_{ripple} = 200mV_{pp}$ sine wave, $C_B = 1.0\mu\text{F}$ Input terminated with 10Ω to ground	63 ($f = 1\text{kHz}$) 62 ($f = 217\text{Hz}$)	55 55	dB (min)
V_{SDIH}	Shutdown High Input Voltage			1.4	V (min)
V_{SDIL}	Shutdown Low Input Voltage			0.4	V (max)
V_{ON}	Output Voltage Noise	A-Weighted, Measured across 8Ω BTL Input terminated with 10Ω to ground	26		μV_{RMS}

Electrical Characteristics $V_{DD} = 2.6V$ (Notes 1, 2)

The following specifications apply for the circuit shown in *Figure 1* unless otherwise specified. Limits apply for $T_A = 25^\circ C$.

Symbol	Parameter	Conditions	LM4897		Units (Limits)
			Typical	Limit	
			(Note 6)	(Notes 7, 8)	
I_{DD}	Quiescent Power Supply Current	$V_{IN} = 0V, 8\Omega$ BTL	3.5	7	mA (max)
I_{SD}	Shutdown Current	$V_{shutdown} = GND$	0.1	2	μA (max)
V_{OS}	Output Offset Voltage		4	30	mV (max)
P_o	Output Power	THD+N = 1% (max), $f = 1kHz$			mW (min)
		$R_L = 8\Omega$	250		
THD+N	Total Harmonic Distortion+Noise	$P_o = 0.1W_{rms}, f = 1kHz$	0.1		%
PSRR	Power Supply Rejection Ratio	$V_{ripple} = 200mV_{pp}$ sine wave, $C_B = 1.0\mu F$ Input terminated with 10Ω to GND	55 ($f = 1kHz$) 55 ($f = 217Hz$)		dB

Note 1: All voltages are measured with respect to the ground pin, unless otherwise specified.

Note 2: *Absolute Maximum Ratings* indicate limits beyond which damage to the device may occur. *Operating Ratings* indicate conditions for which the device is functional, but do not guarantee specific performance limits. *Electrical Characteristics* state DC and AC electrical specifications under particular test conditions which guarantee specific performance limits. This assumes that the device is within the Operating Ratings. Specifications are not guaranteed for parameters where no limit is given, however, the typical value is a good indication of device performance.

Note 3: The maximum power dissipation must be derated at elevated temperatures and is dictated by T_{JMAX} , θ_{JA} , and the ambient temperature T_A . The maximum allowable power dissipation is $P_{DMAX} = (T_{JMAX} - T_A) / \theta_{JA}$ or the number given in Absolute Maximum Ratings, whichever is lower. For the LM4897, see power derating curves for additional information.

Note 4: Human body model, 100pF discharged through a 1.5k Ω resistor.

Note 5: Machine Model, 220pF–240pF discharged through all pins.

Note 6: Typicals are measured at 25°C and represent the parametric norm.

Note 7: Limits are guaranteed to National's AOQL (Average Outgoing Quality Level).

Note 8: Exposure to direct sunlight will increase I_{SD} by a maximum of 2 μA .

Note 9: If the product is in shutdown mode, and V_{DD} exceeds 6V (to a max of 8V V_{DD}), then most of the excess current will flow through the ESD protection circuits. If the source impedance limits the current to a max of 10mA, then the part will be protected. If the part is enabled when V_{DD} is above 6V, circuit performance will be curtailed or the part may be permanently damaged.

Note 10: All bumps have the same thermal resistance and contribute equally when used to lower thermal resistance.

Note 11: Maximum power dissipation (P_{DMAX}) in the device occurs at an output power level significantly below full output power. P_{DMAX} can be calculated using Equation 1 shown in the Application section. It may also be obtained from the power dissipation graphs.

External Components Description

(Figure 1)

Components	Functional Description	
1.	R_i	Inverting input resistance which sets the closed-loop gain in conjunction with R_f . This resistor also forms a high pass filter with C_i at $f_C = 1/(2\pi R_i C_i)$.
2.	C_i	Input coupling capacitor which blocks the DC voltage at the amplifiers input terminals. Also creates a highpass filter with R_i at $f_C = 1/(2\pi R_i C_i)$. Refer to the section, Proper Selection of External Components , for an explanation of how to determine the value of C_i .
3.	R_f	Feedback resistance which sets the closed-loop gain in conjunction with R_i .
4.	C_S	Supply bypass capacitor which provides power supply filtering. Refer to the Power Supply Bypassing section for information concerning proper placement and selection of the supply bypass capacitor.
5.	C_B	Bypass pin capacitor which provides half-supply filtering. Refer to the section, Proper Selection of External Components , for information concerning proper placement and selection of C_B .

Typical Performance Characteristics

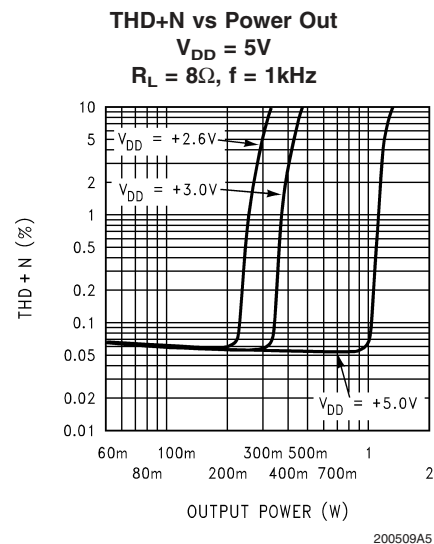
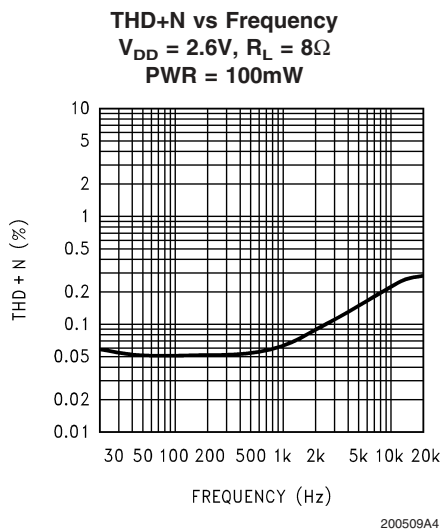
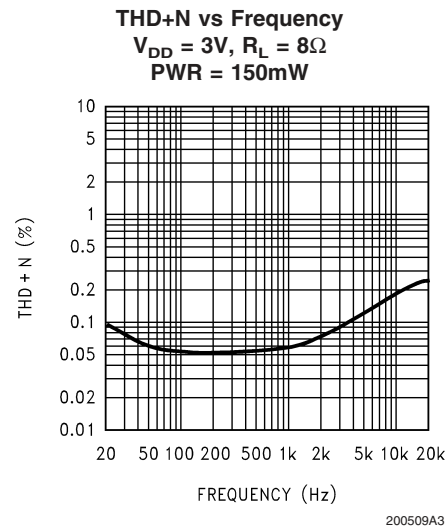
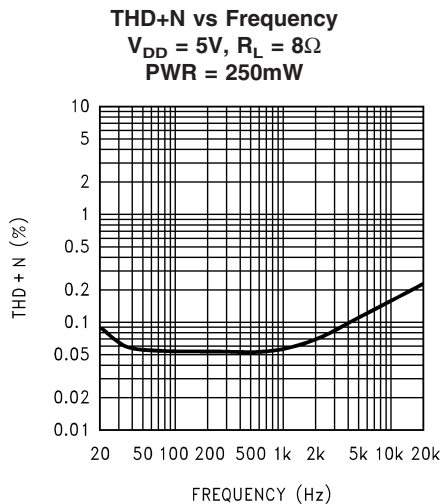

Typical Performance Characteristics (Continued)

Power Supply Rejection Ratio (PSRR), $V_{DD} = 5V$
 $R_L = 8\Omega$, $f = 1kHz$, $C_B = 1\mu F$, $A_V = 2$
 Vripple = 200mVpp, Input terminated with 10Ω

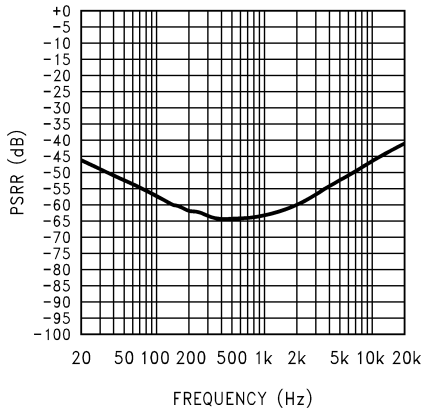

200509A6

Power Supply Rejection Ratio (PSRR), $V_{DD} = 3V$
 $R_L = 8\Omega$, $f = 1kHz$, $C_B = 1\mu F$, $A_V = 2$
 Vripple = 200mVpp, Input terminated with 10Ω

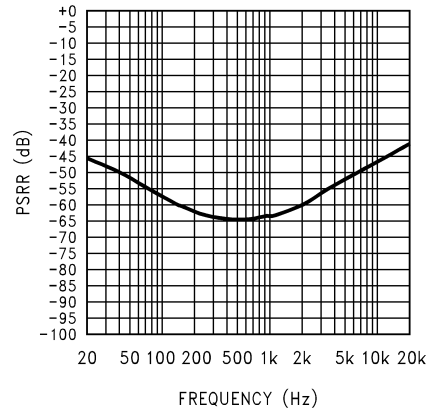

200509A7

Power Supply Rejection Ratio (PSRR), $V_{DD} = 2.6V$
 $R_L = 8\Omega$, $f = 1kHz$, $C_B = 1\mu F$, $A_V = 2$
 Vripple = 200mVpp, Input terminated with 10Ω

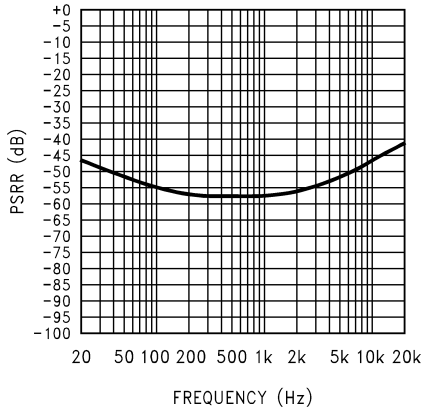

200509A8

Power Dissipation vs Output Power
 $V_{DD} = 5V$, $R_L = 8\Omega$, $f = 1kHz$
 $THD+N \leq 1.0\%$, $BW < 80kHz$

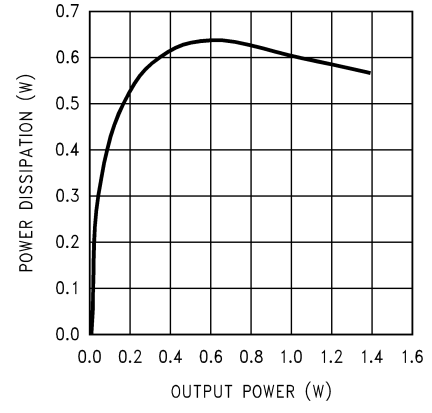

200509A9

Power Dissipation vs Output Power
 $V_{DD} = 3V$, $R_L = 8\Omega$, $f = 1kHz$
 $THD+N \leq 1.0\%$, $BW < 80kHz$

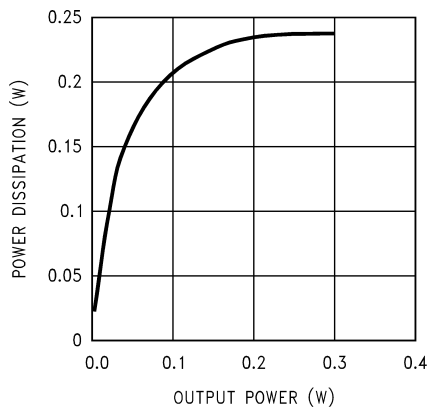

200509B0

Power Dissipation vs Output Power
 $V_{DD} = 2.6V$, $f = 1kHz$
 $THD+N \leq 1.0\%$, $BW < 80kHz$

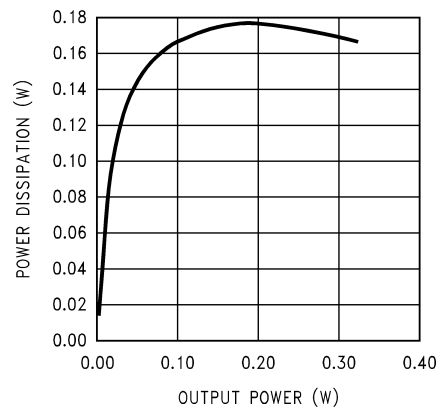

200509B1

Typical Performance Characteristics (Continued)

Power Derating - MSOP

$P_{DMAX} = 670mW$
 $V_{DD} = 5V, R_L = 8\Omega$

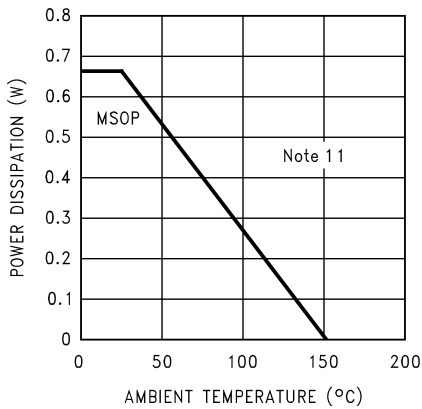

200509B2

Output Power vs Supply Voltage

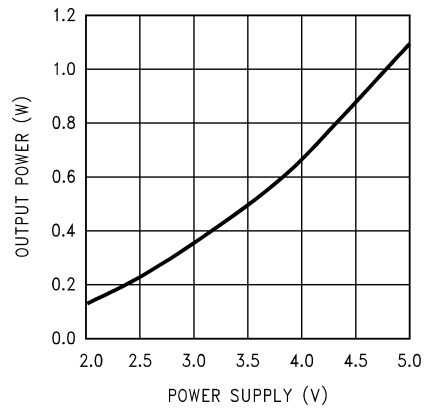

200509B3

Output Power vs Load Resistance

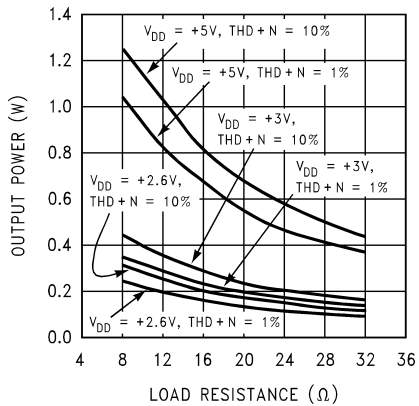

200509B4

Clipping (Dropout) Voltage vs Supply Voltage

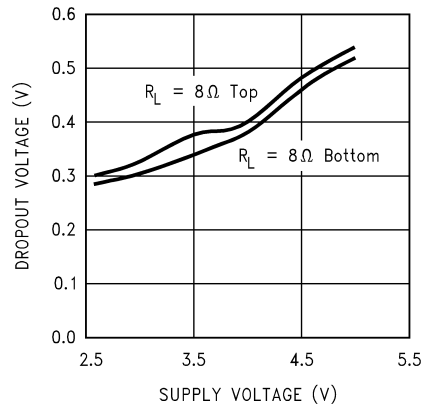

200509B5

Supply Current vs Shutdown Voltage

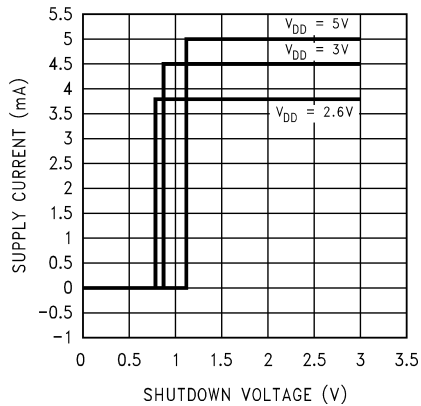

200509B6

Shutdown Hysteresis Voltage

$V_{DD} = 5V$

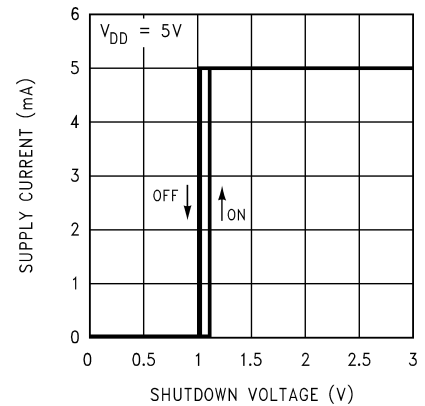

200509B7

Typical Performance Characteristics (Continued)

Shutdown Hysteresis Voltage
 $V_{DD} = 3V$

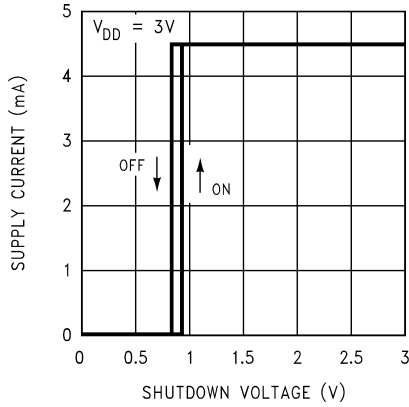

200509B8

Shutdown Hysteresis Voltage
 $V_{DD} = 2.6V$

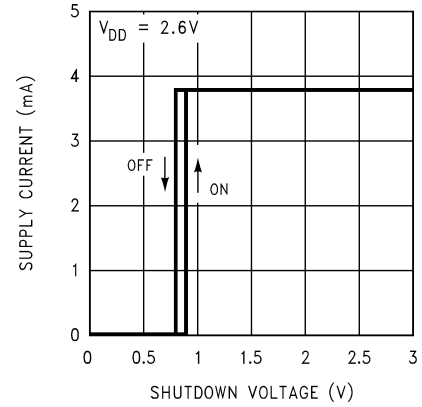

200509B9

Open Loop Frequency Response

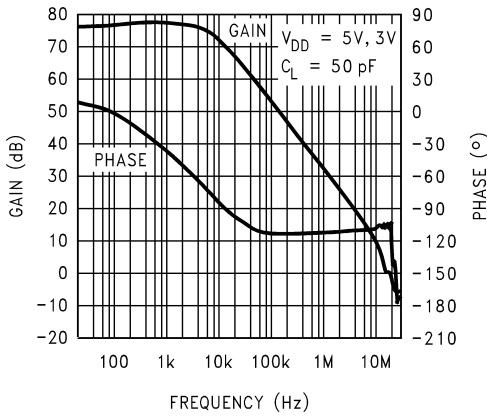

200509C0

Frequency Response vs
 Input Capacitor Size

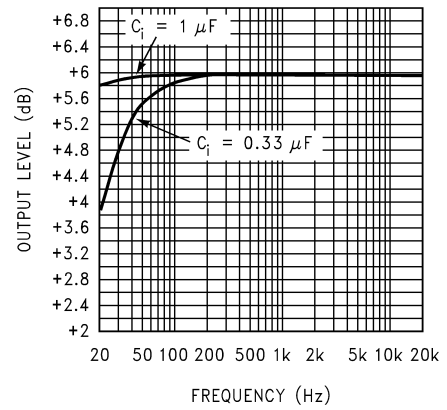

200509C1

Fade-In
 $V_{DD} = 5V, R_L = 8\Omega, f = 1kHz$
 $R_i = 100k\Omega, R_f = 100k\Omega$

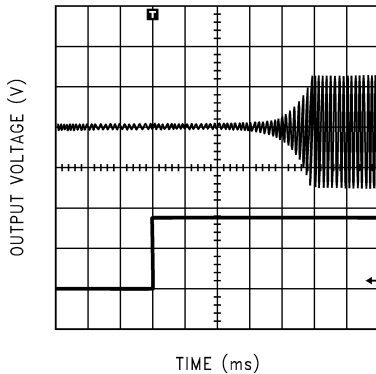

200509C2

Fade-Out
 $V_{DD} = 5V, R_L = 8\Omega, f = 1kHz$
 $R_i = 100k\Omega, R_f = 100k\Omega$

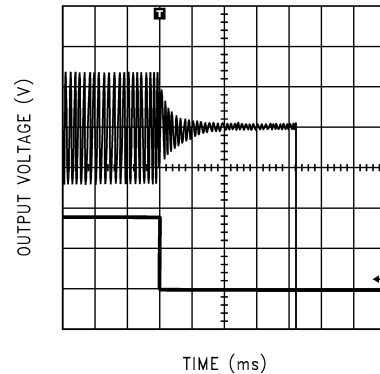

200509C3

Typical Performance Characteristics (Continued)

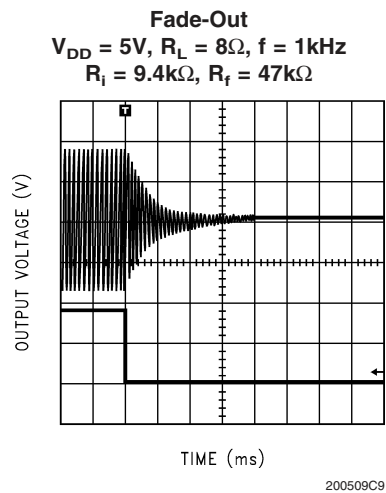
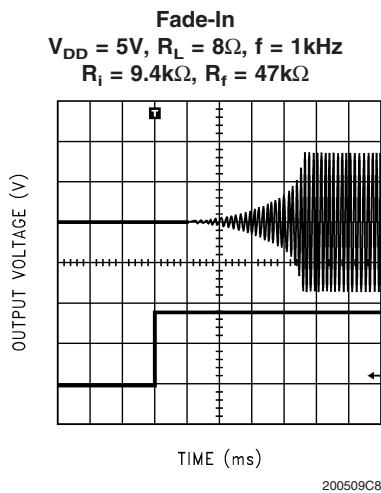
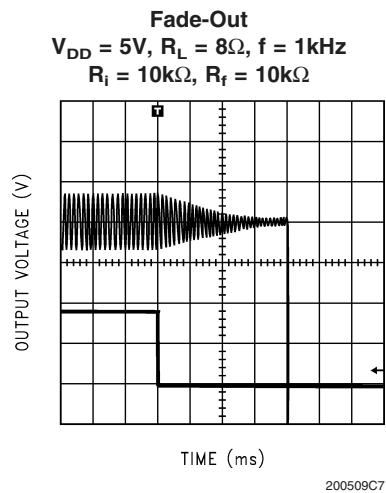
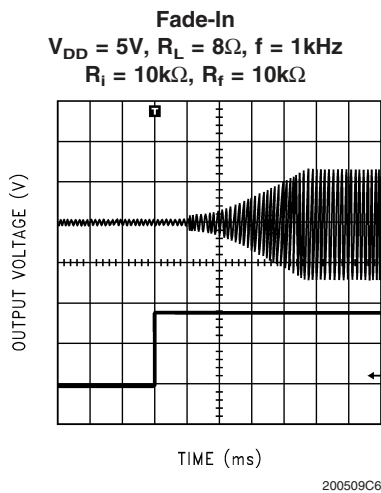
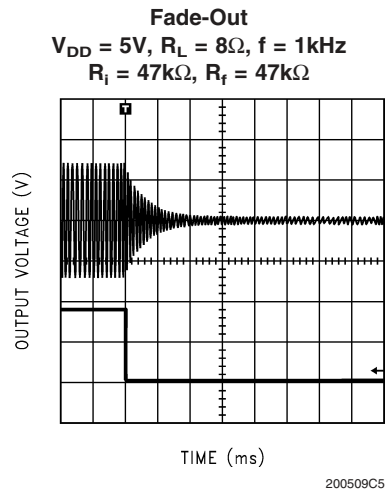
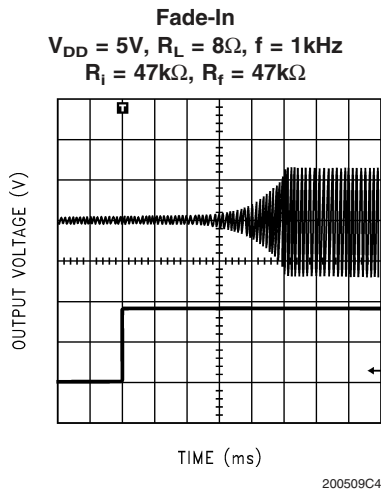

Application Information

BRIDGE CONFIGURATION EXPLANATION

As shown in *Figure 1*, the LM4897 has two operational amplifiers internally, allowing for a few different amplifier configurations. The first amplifier's gain is externally configurable, while the second amplifier is internally fixed in a unity-gain, inverting configuration. The closed-loop gain of the first amplifier is set by selecting the ratio of R_f to R_i while the second amplifier's gain is fixed by the two internal 20k Ω resistors. *Figure 1* shows that the output of amplifier one serves as the input to amplifier two which results in both amplifiers producing signals identical in magnitude, but out of phase by 180°. Consequently, the differential gain for the IC is

$$A_{VD} = 2 * (R_f/R_i)$$

By driving the load differentially through outputs Vo1 and Vo2, an amplifier configuration commonly referred to as "bridged mode" is established. Bridged mode operation is different from the classical single-ended amplifier configuration where one side of the load is connected to ground.

A bridge amplifier design has a few distinct advantages over the single-ended configuration, as it provides differential drive to the load, thus doubling output swing for a specified supply voltage. Four times the output power is possible as compared to a single-ended amplifier under the same conditions. This increase in attainable output power assumes that the amplifier is not current limited or clipped. In order to choose an amplifier's closed-loop gain without causing excessive clipping, please refer to the **Audio Power Amplifier Design** section.

A bridge configuration, such as the one used in LM4897, also creates a second advantage over single-ended amplifiers. Since the differential outputs, Vo1 and Vo2, are biased at half-supply, no net DC voltage exists across the load. This eliminates the need for an output coupling capacitor which is required in a single supply, single-ended amplifier configuration. Without an output coupling capacitor, the half-supply bias across the load would result in both increased internal IC power dissipation and also possible loudspeaker damage.

POWER DISSIPATION

Power dissipation is a major concern when designing a successful amplifier, whether the amplifier is bridged or single-ended. A direct consequence of the increased power delivered to the load by a bridge amplifier is an increase in internal power dissipation. Since the LM4897 has two operational amplifiers in one package, the maximum internal power dissipation is 4 times that of a single-ended amplifier. The maximum power dissipation for a given application can be derived from the power dissipation graphs or from Equation 1.

$$P_{DMAX} = 4 * (V_{DD})^2 / (2\pi^2 R_L) \quad (1)$$

It is critical that the maximum junction temperature (T_{JMAX}) of 150°C is not exceeded. T_{JMAX} can be determined from the power derating curves by using P_{DMAX} and the PC board foil area. By adding additional copper foil, the thermal resistance of the application can be reduced from a free air value of 150°C/W, resulting in higher P_{DMAX} . Additional copper foil can be added to any of the leads connected to the LM4897. It is especially effective when connected to V_{DD} , GND, and the output pins. Refer to the application information on the LM4897 reference design board for an example of good heat sinking. If T_{JMAX} still exceeds 150°C, then additional changes must be made. These changes can include re-

duced supply voltage, higher load impedance, or reduced ambient temperature. Internal power dissipation is a function of output power. Refer to the **Typical Performance Characteristics** curves for power dissipation information for different output powers and output loading.

POWER SUPPLY BYPASSING

As with any amplifier, proper supply bypassing is critical for low noise performance and high power supply rejection. The capacitor location on both the bypass and power supply pins should be as close to the device as possible. Typical applications employ a 5V regulator with 10 μ F tantalum or electrolytic capacitor and a ceramic bypass capacitor which aid in supply stability. This does not eliminate the need for bypassing the supply nodes of the LM4897. The selection of a bypass capacitor, especially C_B , is dependent upon PSRR requirements, click and pop performance (as explained in the section, **Proper Selection of External Components**), system cost, and size constraints.

SHUTDOWN FUNCTION

In order to reduce power consumption while not in use, the LM4897 contains a shutdown pin to externally turn off the amplifier's bias circuitry. This shutdown feature turns the amplifier off when a logic low is placed on the shutdown pin. By switching the shutdown pin to ground, the LM4897 supply current draw will be minimized in idle mode. While the device will be disabled with shutdown pin voltages less than 0.4V_{DC}, the idle current may be greater than the typical value of 0.1 μ A. (Idle current is measured with the shutdown pin tied to ground).

In many applications, a microcontroller or microprocessor output is used to control the shutdown circuitry to provide a quick, smooth transition into shutdown. Another solution is to use a single-pole, single-throw switch in conjunction with an external pull-up resistor. When the switch is closed, the shutdown pin is connected to ground which disables the amplifier. If the switch is open, then the external pull-up resistor to V_{DD} will enable the LM4897. This scheme guarantees that the shutdown pin will not float thus preventing unwanted state changes.

PROPER SELECTION OF EXTERNAL COMPONENTS

Proper selection of external components in applications using integrated power amplifiers is critical to optimize device and system performance. While the LM4897 is tolerant of external component combinations, consideration to component values must be used to maximize overall system quality.

The LM4897 is unity-gain stable which gives the designer maximum system flexibility. The LM4897 should be used in low gain configurations to minimize THD+N values, and maximize the signal to noise ratio. Low gain configurations require large input signals to obtain a given output power. Input signals equal to or greater than 1 V_{rms} are available from sources such as audio codecs. Please refer to the section, **Audio Power Amplifier Design**, for a more complete explanation of proper gain selection.

Besides gain, one of the major considerations is the closed-loop bandwidth of the amplifier. To a large extent, the bandwidth is dictated by the choice of external components shown in *Figure 1*. The input coupling capacitor, C_i , forms a first order high pass filter which limits low frequency response. This value should be chosen based on needed frequency response for a few distinct reasons.

Application Information (Continued)

Selection Of Input Capacitor Size

Large input capacitors are both expensive and space hungry for portable designs. Clearly, a certain sized capacitor is needed to couple in low frequencies without severe attenuation. But in many cases the speakers used in portable systems, whether internal or external, have little ability to reproduce signals below 100Hz to 150Hz. Thus, using a large input capacitor may not increase actual system performance.

In addition to system cost and size, click and pop performance is effected by the size of the input coupling capacitor, C_i . A larger input coupling capacitor requires more charge to reach its quiescent DC voltage (nominally $1/2 V_{DD}$). This charge comes from the output via the feedback and is apt to create pops upon device enable. Thus, by minimizing the capacitor size based on necessary low frequency response, turn-on pops can be minimized.

Besides minimizing the input capacitor size, careful consideration should be paid to the bypass capacitor value. Bypass capacitor, C_B , is the most critical component to minimize turn-on pops since it determines how fast the LM4897 turns on. The slower the LM4897's outputs ramp to their quiescent DC voltage (nominally $1/2 V_{DD}$), the smaller the turn-on pop. Choosing C_B equal to $1.0\mu\text{F}$ along with a small value of C_i (in the range of $0.1\mu\text{F}$ to $0.39\mu\text{F}$), should produce a virtually clickless and popless shutdown function. While the device will function properly, (no oscillations or motorboating), with C_B equal to $0.1\mu\text{F}$, the device will be much more susceptible to turn-on clicks and pops. Thus, a value of C_B equal to $1.0\mu\text{F}$ is recommended in all but the most cost sensitive designs.

AUDIO POWER AMPLIFIER DESIGN

A 1W/8Ω Audio Amplifier

Given:

Power Output	1 Wrms
Load Impedance	8Ω
Input Level	1 Vrms
Input Impedance	20kΩ
Bandwidth	100Hz – 20kHz ± 0.2 dB

A designer must first determine the minimum supply rail to obtain the specified output power. By extrapolating from the Output Power vs Supply Voltage graphs in the **Typical Per-**

formance Characteristics section, the supply rail can be easily found. A second way to determine the minimum supply rail is to calculate the required V_{opeak} using Equation 2 and add the output voltage. Using this method, the minimum supply voltage would be $(V_{\text{opeak}} + (V_{\text{ODTOP}} + V_{\text{ODBOT}}))$, where V_{ODBOT} and V_{ODTOP} are extrapolated from the Dropout Voltage vs Supply Voltage curve in the **Typical Performance Characteristics** section.

$$V_{\text{opeak}} = \sqrt{(2R_L P_O)} \quad (2)$$

5V is a standard voltage, in most applications, chosen for the supply rail. Extra supply voltage creates headroom that allows the LM4897 to reproduce peaks in excess of 1W without producing audible distortion. At this time, the designer must make sure that the power supply choice along with the output impedance does not violate the conditions explained in the **Power Dissipation** section.

Once the power dissipation equations have been addressed, the required differential gain can be determined from Equation 3.

$$A_{VD} \geq \sqrt{(P_O R_L)} / (V_{IN}) = V_{\text{orms}} / V_{\text{inrms}} \quad (3)$$

$$A_{VD} = (R_f / R_i)^2$$

From Equation 3, the minimum A_{VD} is 2.83; use $A_{VD} = 3$.

Since the desired input impedance was $20\text{k}\Omega$, and with a A_{VD} of 3, a ratio of 1.5:1 of R_f to R_i results in an allocation of $R_i = 20\text{k}\Omega$ and $R_f = 30\text{k}\Omega$. The final design step is to address the bandwidth requirements which must be stated as a pair of -3dB frequency points. Five times away from a -3dB point is 0.17dB down from passband response which is better than the required $\pm 0.25\text{dB}$ specified.

$$f_L = 100\text{Hz} / 5 = 20\text{Hz}$$

$$f_H = 20\text{kHz} * 5 = 100\text{kHz}$$

As stated in the **External Components** section, R_i in conjunction with C_i create a highpass filter.

$$C_i \geq 1 / (2\pi * 20\text{k}\Omega * 20\text{Hz}) = 0.397\mu\text{F}; \text{ use } 0.39\mu\text{F}$$

The high frequency pole is determined by the product of the desired frequency pole, f_H , and the differential gain, A_{VD} . With a $A_{VD} = 3$ and $f_H = 100\text{kHz}$, the resulting GBWP = 300kHz which is much smaller than the LM4897 GBWP of 10MHz . This figure displays that if a designer has a need to design an amplifier with a higher differential gain, the LM4897 can still be used without running into bandwidth limitations.

Application Information (Continued)

LM4897 FADE-IN / FADE-OUT

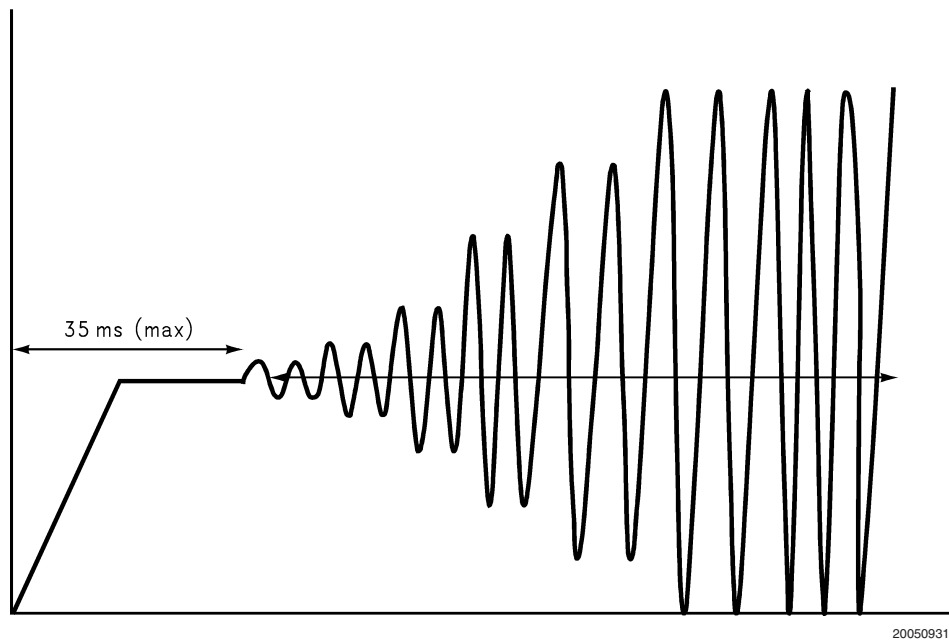

FIGURE 2. Fade-In Behavior

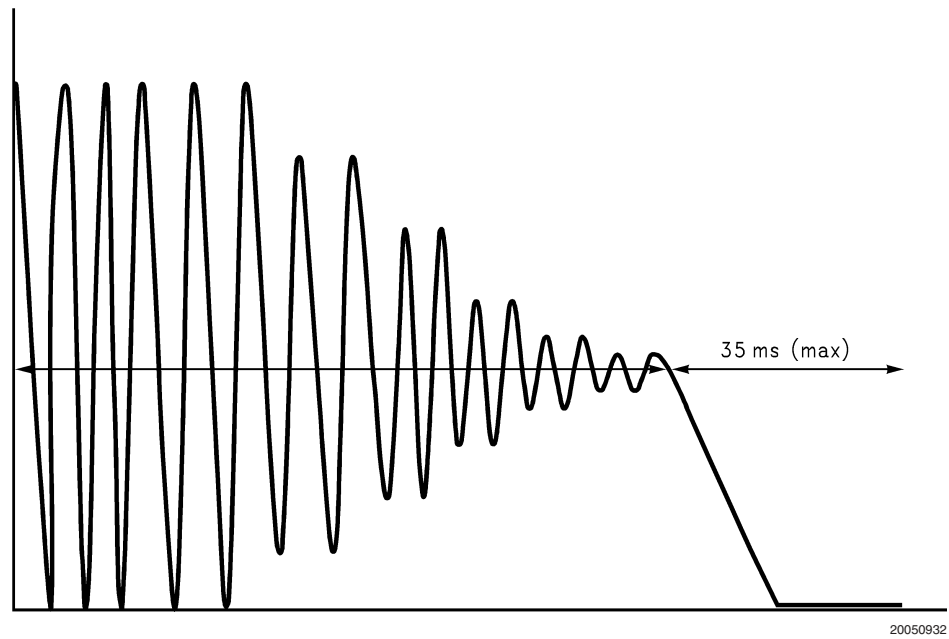
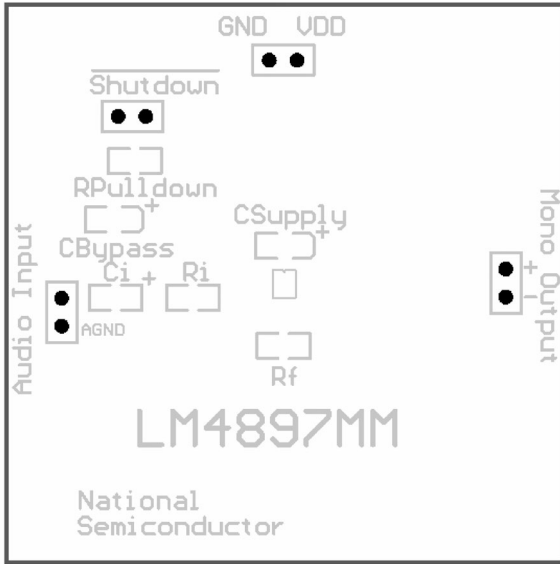

FIGURE 3. Fade-Out Behavior

Application Information (Continued)

LM4897 MSOP DEMO BOARD ARTWORK

Top Overlay



20050999

Top Layer

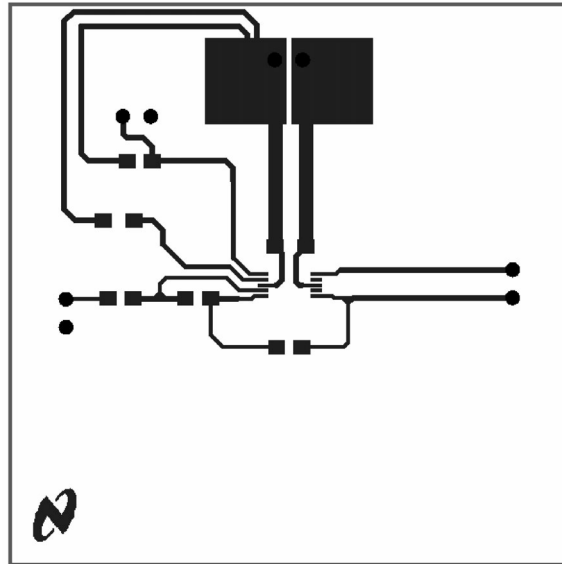

200509A0

Bottom Layer

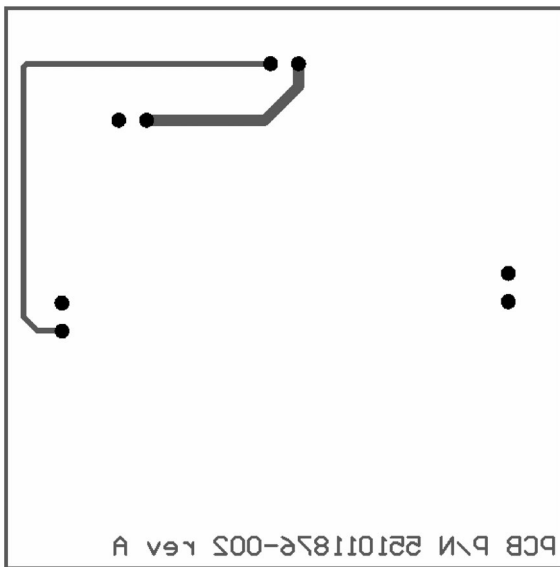

200509A1

PCB P\N 221011876-002 rev A

Physical Dimensions inches (millimeters) unless otherwise noted

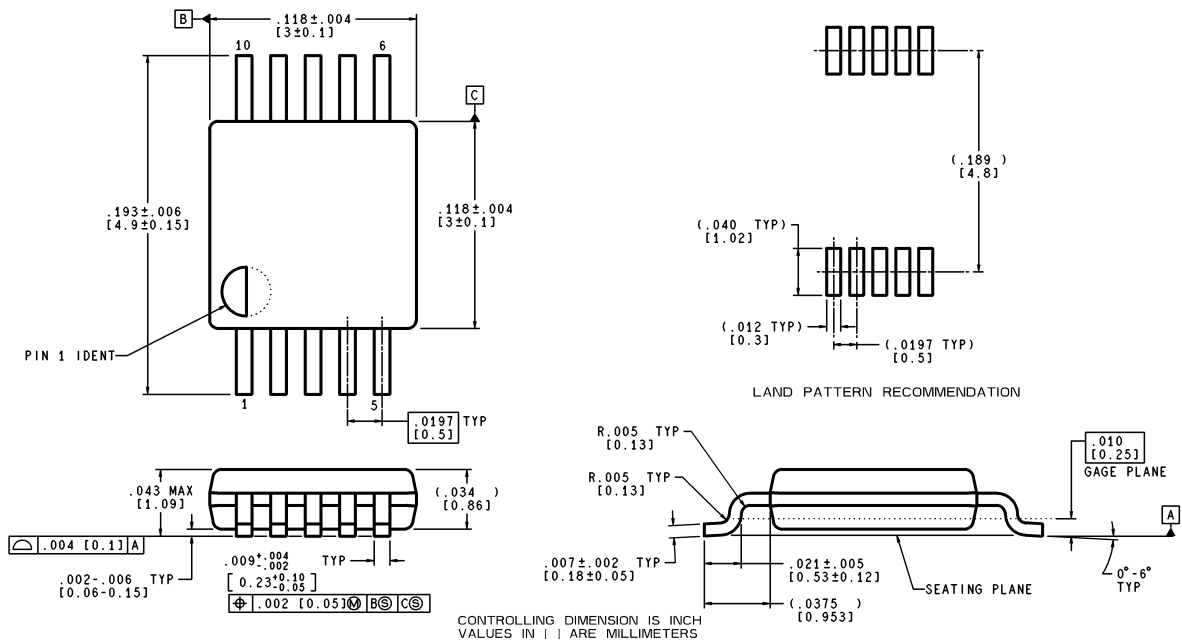

MUB10A (Rev A)

MSOP
Order Number LM4897MM
NS Package Number MUB10A

LIFE SUPPORT POLICY

NATIONAL'S PRODUCTS ARE NOT AUTHORIZED FOR USE AS CRITICAL COMPONENTS IN LIFE SUPPORT DEVICES OR SYSTEMS WITHOUT THE EXPRESS WRITTEN APPROVAL OF THE PRESIDENT AND GENERAL COUNSEL OF NATIONAL SEMICONDUCTOR CORPORATION. As used herein:

1. Life support devices or systems are devices or systems which, (a) are intended for surgical implant into the body, or (b) support or sustain life, and whose failure to perform when properly used in accordance with instructions for use provided in the labeling, can be reasonably expected to result in a significant injury to the user.
2. A critical component is any component of a life support device or system whose failure to perform can be reasonably expected to cause the failure of the life support device or system, or to affect its safety or effectiveness.



National Semiconductor
Americas Customer
Support Center
Email: new.feedback@nsc.com
Tel: 1-800-272-9959

National Semiconductor
Europe Customer Support Center
Fax: +49 (0) 180-530 85 86
Email: europe.support@nsc.com
Deutsch Tel: +49 (0) 69 9508 6208
English Tel: +44 (0) 870 24 0 2171
Français Tel: +33 (0) 1 41 91 8790

National Semiconductor
Asia Pacific Customer
Support Center
Email: ap.support@nsc.com

National Semiconductor
Japan Customer Support Center
Fax: 81-3-5639-7507
Email: jpn.feedback@nsc.com
Tel: 81-3-5639-7560

www.national.com