

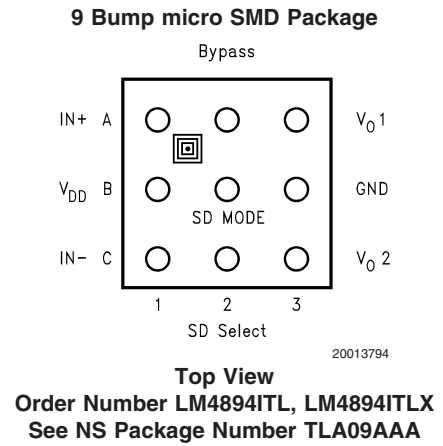

### Connection Diagrams (Continued)

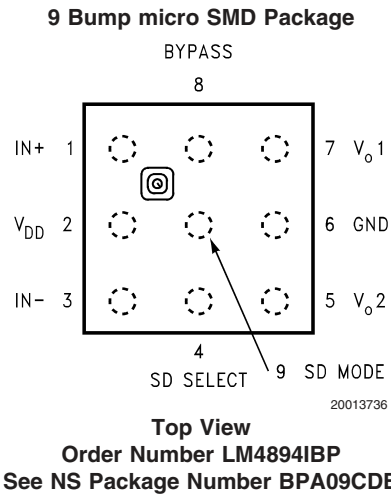

### Typical Application

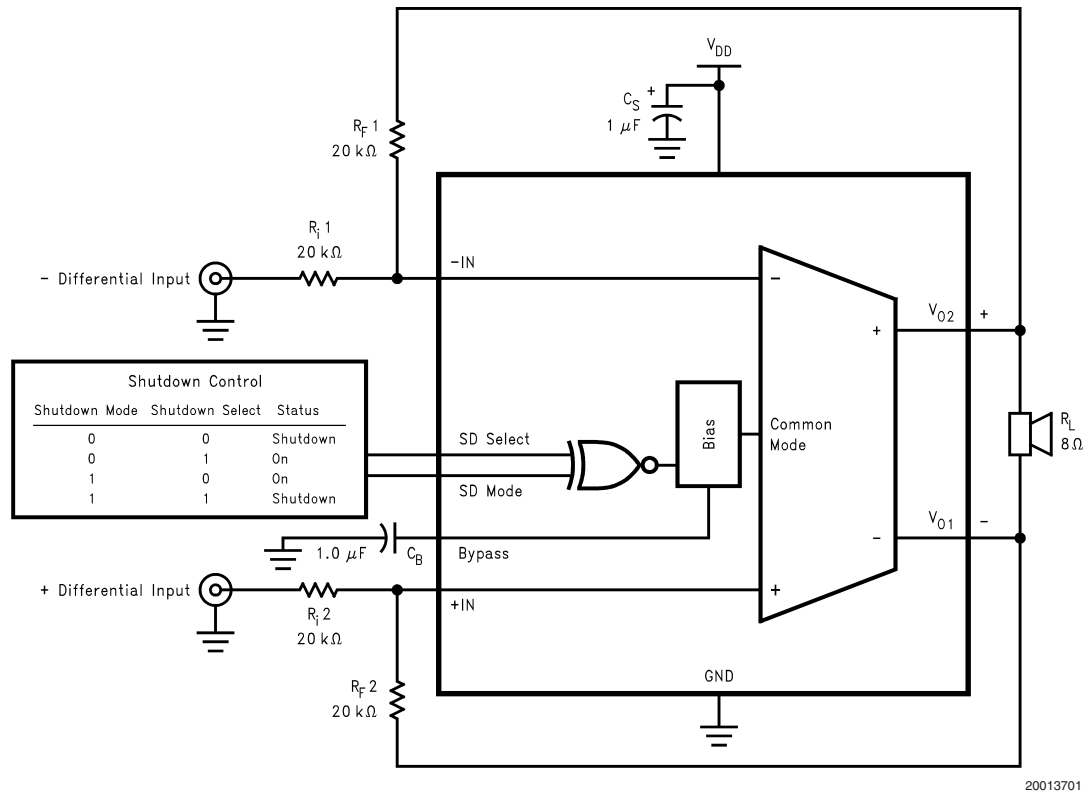

FIGURE 1. Typical Audio Amplifier Application Circuit

**Absolute Maximum Ratings** (Note 2)

If Military/Aerospace specified devices are required, please contact the National Semiconductor Sales Office/Distributors for availability and specifications.

Supply Voltage	6.0V
Storage Temperature	-65°C to +150°C
Input Voltage	-0.3V to $V_{DD} + 0.3V$
Power Dissipation (Note 3)	Internally Limited
ESD Susceptibility (Note 4)	2000V
ESD Susceptibility (Note 5)	200V
Junction Temperature	150°C
Thermal Resistance	
$\theta_{JC}$ (LLP)	12°C/W
$\theta_{JA}$ (LLP)	63°C/W

$\theta_{JA}$ (micro SMD)	220°C/W
$\theta_{JC}$ (MSOP)	56°C/W
$\theta_{JA}$ (MSOP)	190°C/W

**Soldering Information**

See AN-1112 "microSMD Wafers Level Chip Scale Package."

See AN-1187 "Leadless Leadframe Package (LLP)."

**Operating Ratings****Temperature Range**

$T_{MIN} \leq T_A \leq T_{MAX}$	-40°C $\leq T_A \leq$ 85°C
Supply Voltage	2.2V $\leq V_{DD} \leq$ 5.5V

**Electrical Characteristics  $V_{DD} = 5V$**  (Notes 1, 2, 8)

The following specifications apply for  $V_{DD} = 5V$ ,  $A_V = 1$ , and  $8\Omega$  load unless otherwise specified. Limits apply for  $T_A = 25^\circ C$ .

Symbol	Parameter	Conditions	LM4894		Units (Limits)
			Typical	Limit	
			(Note 6)	(Note 7)	
$I_{DD}$	Quiescent Power Supply Current	$V_{IN} = 0V, I_o = 0A$	4	8	mA (max)
$I_{SD}$	Shutdown Current	$V_{shutdown} = GND$	0.1	1	$\mu A$ (max)
$P_o$	Output Power	THD = 1% (max); f = 1 kHz			
		LM4894LD, $R_L = 4\Omega$ (Note 11)	1.4		W (min)
		LM4894, $R_L = 8\Omega$	1	0.850	
THD+N	Total Harmonic Distortion+Noise	$P_o = 0.4 W_{rms}$ ; f = 1kHz	0.1		%
PSRR	Power Supply Rejection Ratio	$V_{ripple} = 200mV$ sine p-p			
		f = 217Hz (Note 9)	87		dB (min)
		f = 1kHz (Note 9)	83		
		f = 217Hz (Note 10)	83	63	
f = 1kHz (Note 10)	80				
CMRR	Common_Mode Rejection Ratio	f = 217Hz	50		dB

**Electrical Characteristics  $V_{DD} = 3V$**  (Notes 1, 2, 8)

The following specifications apply for  $V_{DD} = 3V$ ,  $A_V = 1$ , and  $8\Omega$  load unless otherwise specified. Limits apply for  $T_A = 25^\circ C$ .

Symbol	Parameter	Conditions	LM4894		Units (Limits)
			Typical	Limit	
			(Note 6)	(Note 7)	
$I_{DD}$	Quiescent Power Supply Current	$V_{IN} = 0V, I_o = 0A$	3.5	6	mA (max)
$I_{SD}$	Shutdown Current	$V_{shutdown} = GND$	0.1	1	$\mu A$ (max)
$P_o$	Output Power	THD = 1% (max); f = 1kHz	0.35		W
THD+N	Total Harmonic Distortion+Noise	$P_o = 0.25W_{rms}$ ; f = 1kHz	0.325		%
PSRR	Power Supply Rejection Ratio	$V_{ripple} = 200mV$ sine p-p			
		f = 217Hz (Note 9)	87		dB
		f = 1kHz (Note 9)	83		
		f = 217Hz (Note 10)	80		
f = 1kHz (Note 10)	78				
CMRR	Common-Mode Rejection Ratio	f = 217Hz	49		dB

## Electrical Characteristics $V_{DD} = 3V$ (Notes 1, 2, 8)

The following specifications apply for  $V_{DD} = 3V$ ,  $A_V = 1$ , and  $8\Omega$  load unless otherwise specified. Limits apply for  $T_A = 25^\circ C$ . (Continued)

**Note 1:** All voltages are measured with respect to the ground pin, unless otherwise specified.

**Note 2:** *Absolute Maximum Ratings* indicate limits beyond which damage to the device may occur. *Operating Ratings* indicate conditions for which the device is functional, but do not guarantee specific performance limits. *Electrical Characteristics* state DC and AC electrical specifications under particular test conditions which guarantee specific performance limits. This assumes that the device is within the Operating Ratings. Specifications are not guaranteed for parameters where no limit is given, however, the typical value is a good indication of device performance.

**Note 3:** The maximum power dissipation must be derated at elevated temperatures and is dictated by  $T_{JMAX}$ ,  $\theta_{JA}$ , and the ambient temperature  $T_A$ . The maximum allowable power dissipation is  $P_{DMAX} = (T_{JMAX} - T_A) / \theta_{JA}$  or the number given in Absolute Maximum Ratings, whichever is lower. For the LM4894, see power derating currents for additional information.

**Note 4:** Human body model, 100pF discharged through a 1.5k $\Omega$  resistor.

**Note 5:** Machine Model, 220pF–240pF discharged through all pins.

**Note 6:** Typicals are measured at  $25^\circ C$  and represent the parametric norm.

**Note 7:** Datasheet min/max specification limits are guaranteed by design, test, or statistical analysis.

**Note 8:** For micro SMD only, shutdown current is measured in a Normal Room Environment. Exposure to direct sunlight will increase  $I_{SD}$  by a maximum of 2 $\mu A$ .

**Note 9:** Unterminated input.

**Note 10:** 10 $\Omega$  terminated input.

**Note 11:** When driving 4 $\Omega$  loads from a 5V supply, the LM4894LD must be mounted to a circuit board.

## External Components Description

(Figure 1)

Components		Functional Description
1.	$R_i$	Inverting input resistance which sets the closed-loop gain in conjunction with $R_f$ .
2.	$R_f$	Feedback resistance which sets the closed-loop gain in conjunction with $R_i$ .
3.	$C_S$	Supply bypass capacitor which provides power supply filtering. Refer to the <b>Power Supply Bypassing</b> section for information concerning proper placement and selection of the supply bypass capacitor.
4.	$C_B$	Bypass pin capacitor which provides half-supply filtering. Refer to the section, <b>Proper Selection of External Components</b> , for information concerning proper placement and selection of $C_B$ .

# Typical Performance Characteristics

## LD Specific Characteristics

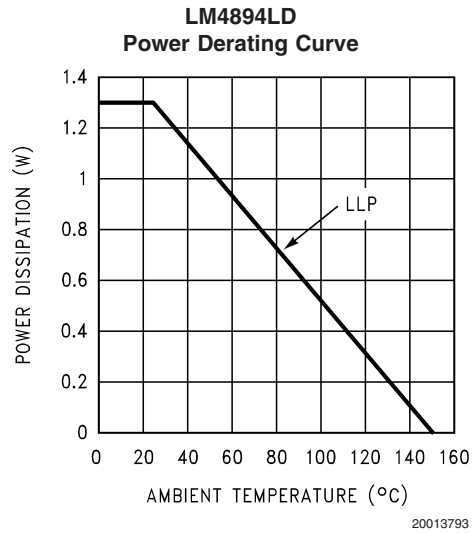
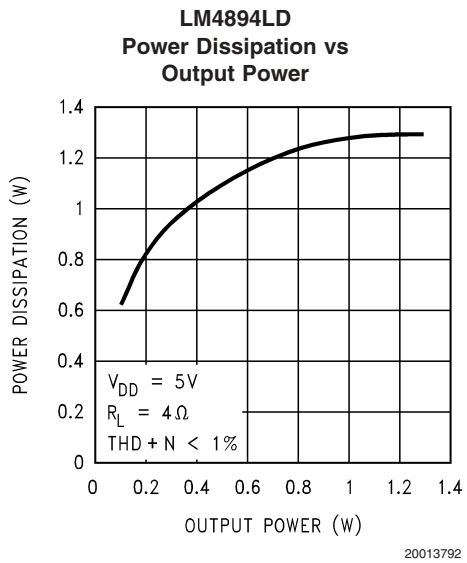
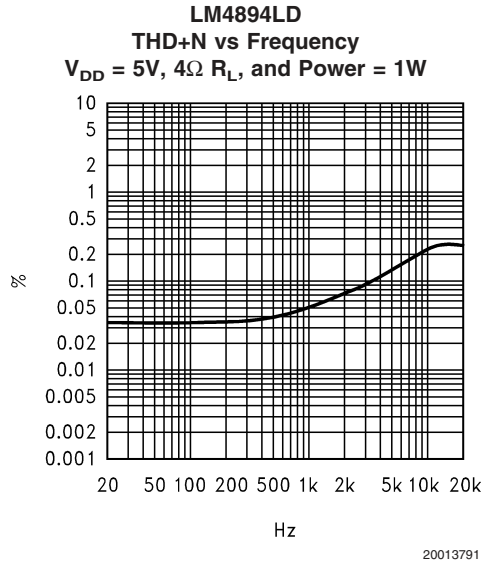
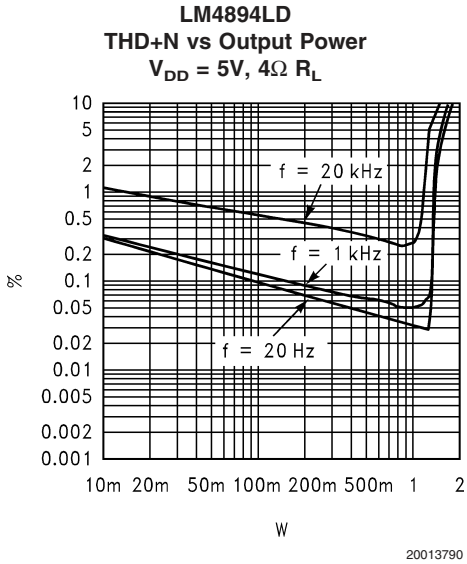

# Typical Performance Characteristics Non-LD Specific Characteristics

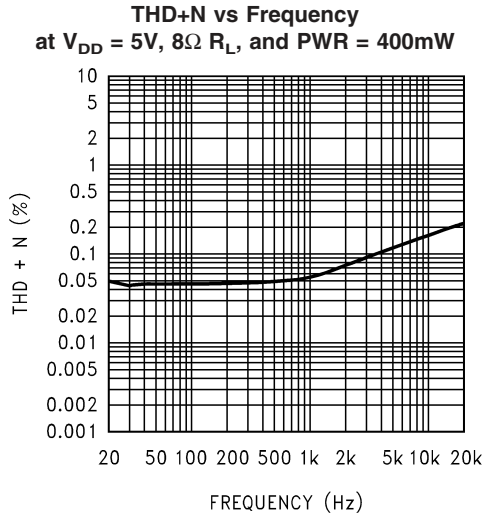

20013737

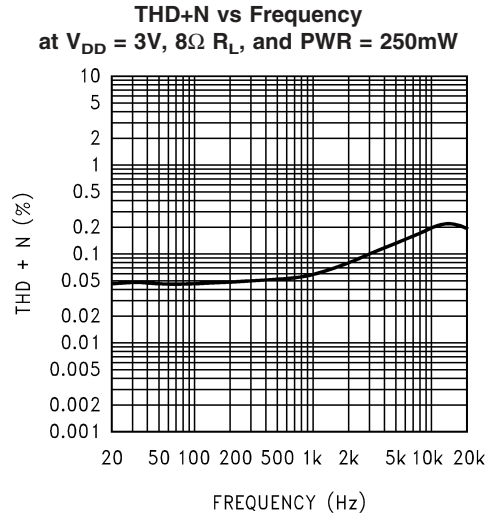

20013738

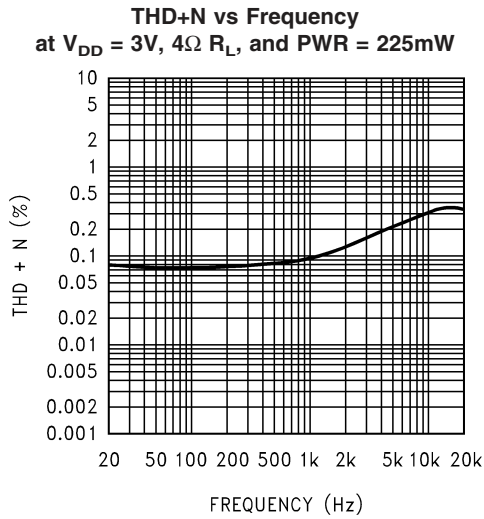

20013739

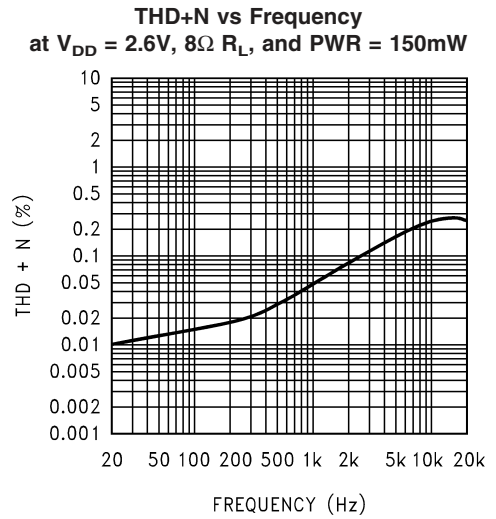

20013740

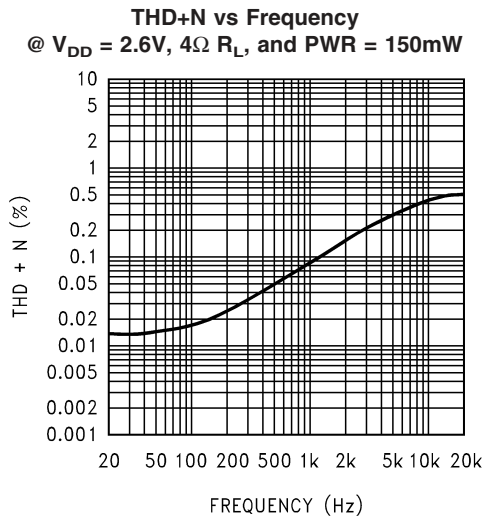

20013741

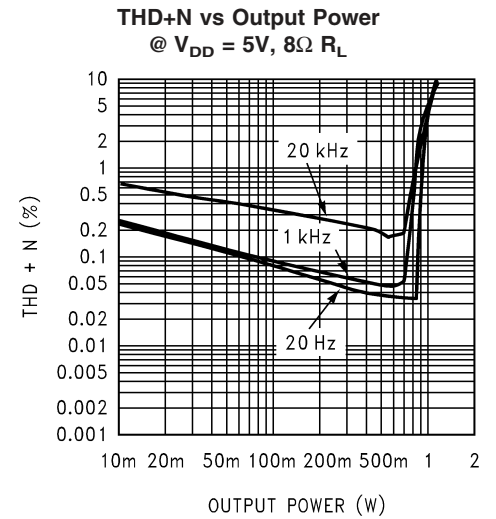

20013742

# Typical Performance Characteristics

## Non-LD Specific Characteristics (Continued)

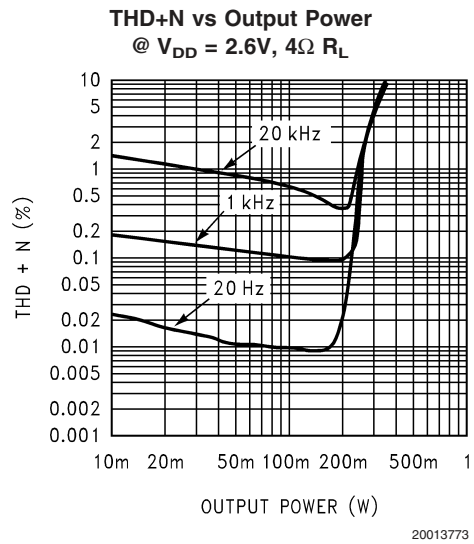
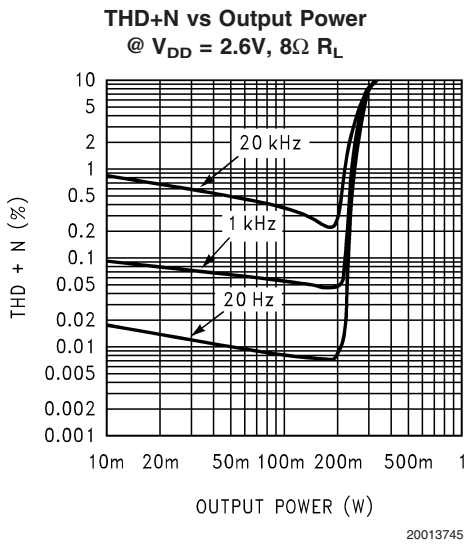
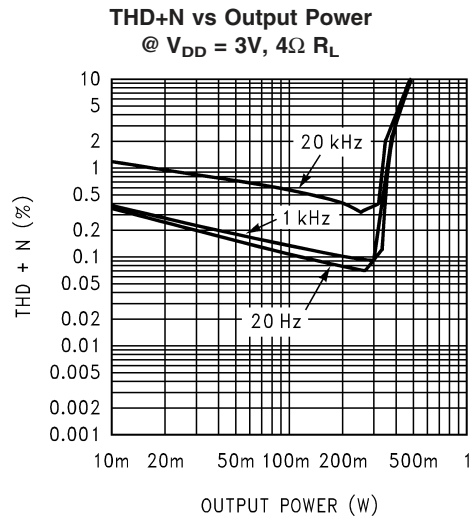
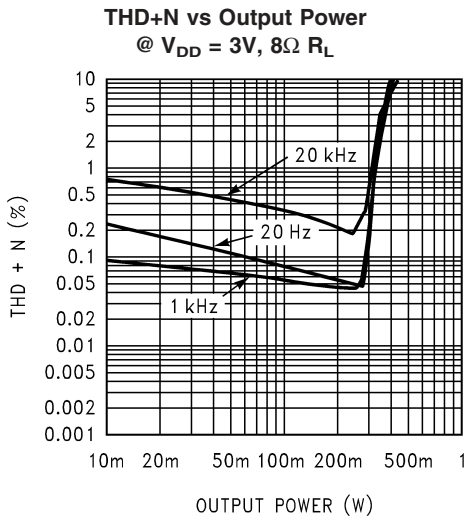

**Power Supply Rejection Ratio (PSRR) @  $V_{DD} = 5V$**   
 Input  $10\Omega$  Terminated

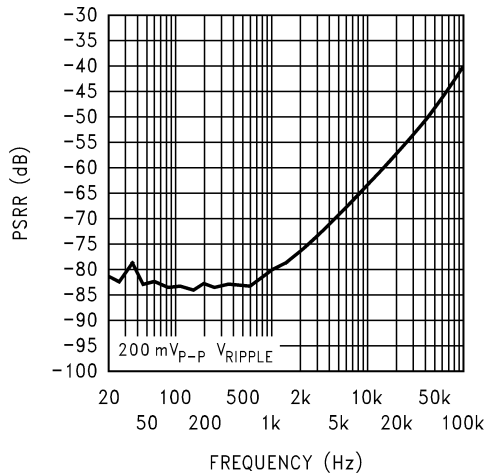

**Power Supply Rejection Ratio (PSRR) @  $V_{DD} = 5V$**   
 Input Floating

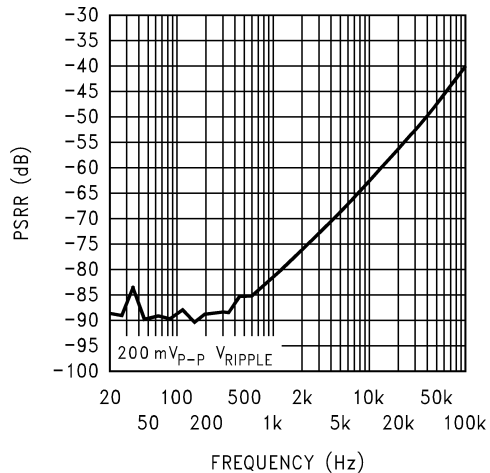

# Typical Performance Characteristics

## Non-LD Specific Characteristics (Continued)

**Power Supply Rejection Ratio (PSRR) @  $V_{DD} = 3V$   
Input 10 $\Omega$  Terminated**

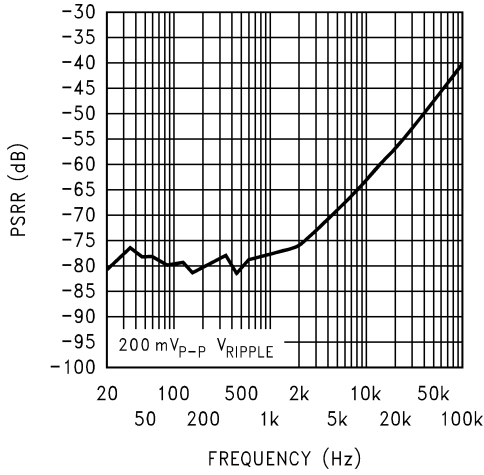

**Power Supply Rejection Ratio (PSRR) @  $V_{DD} = 3V$   
Input Floating**

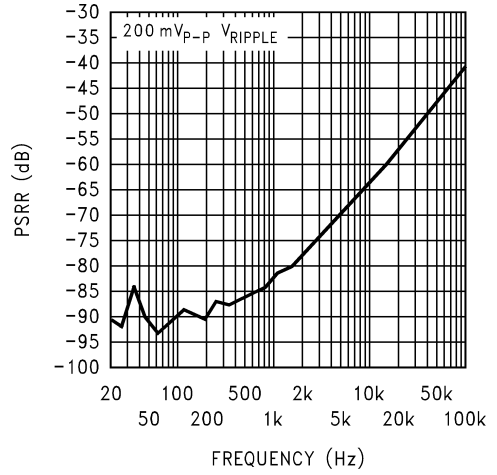

**Output Power vs  
Supply Voltage**

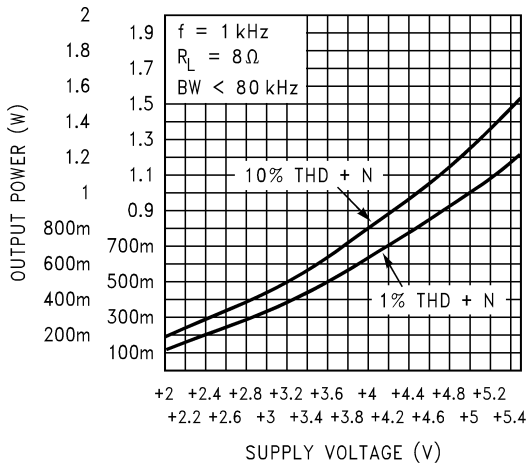

**Output Power vs  
Supply Voltage**

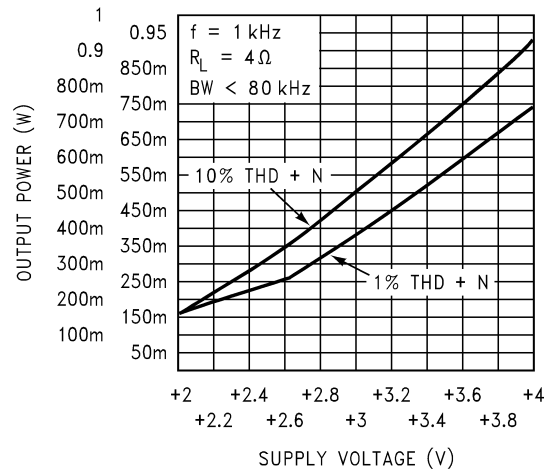

**Power Dissipation vs  
Output Power**

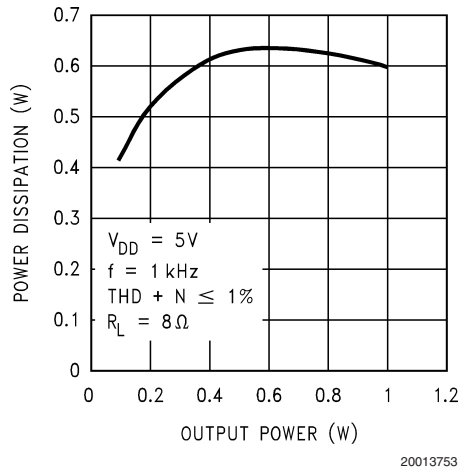

**Power Dissipation vs  
Output Power**

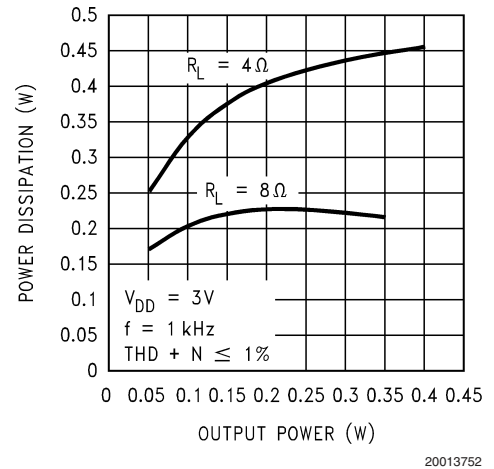



# Typical Performance Characteristics

## Non-LD Specific Characteristics (Continued)

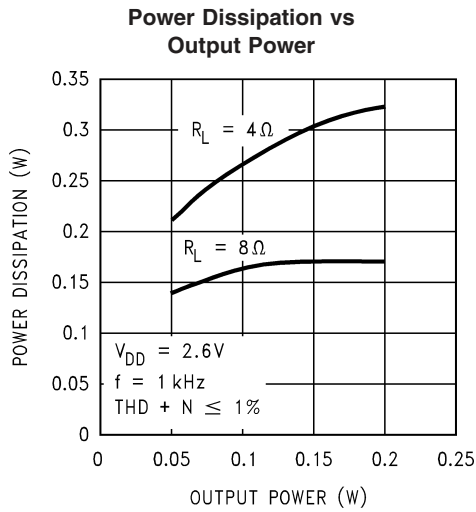

20013755

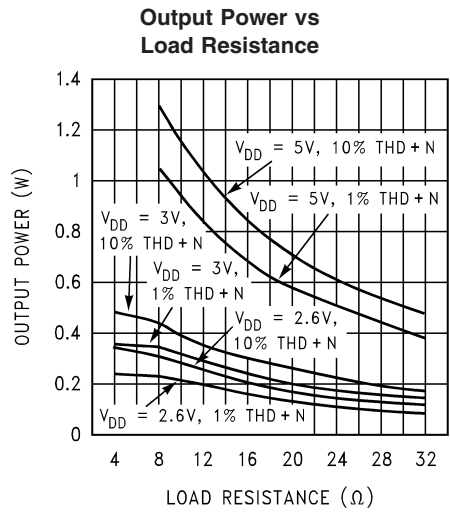

20013754

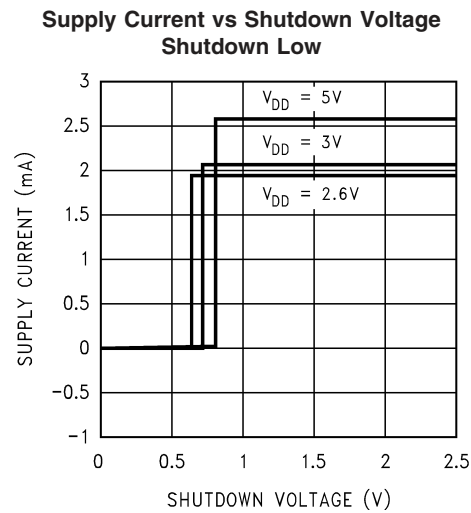

20013769

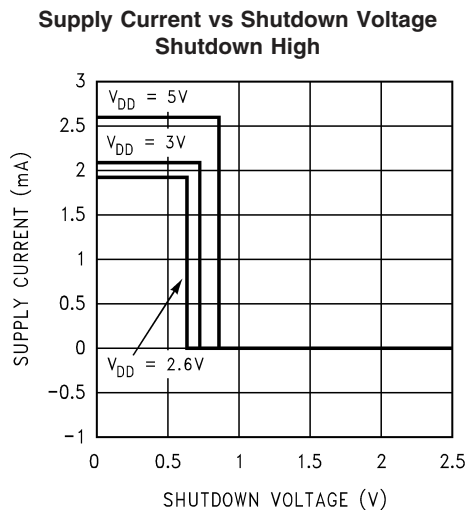

20013756

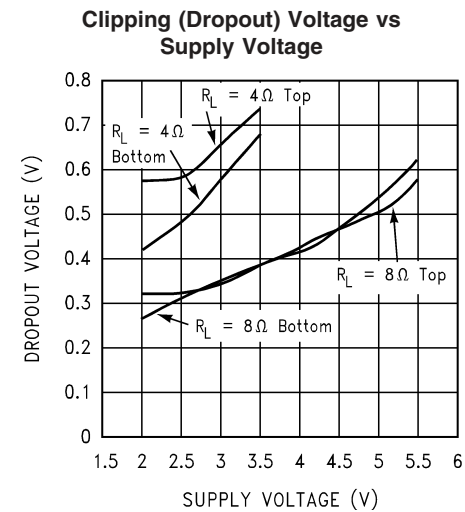

20013774

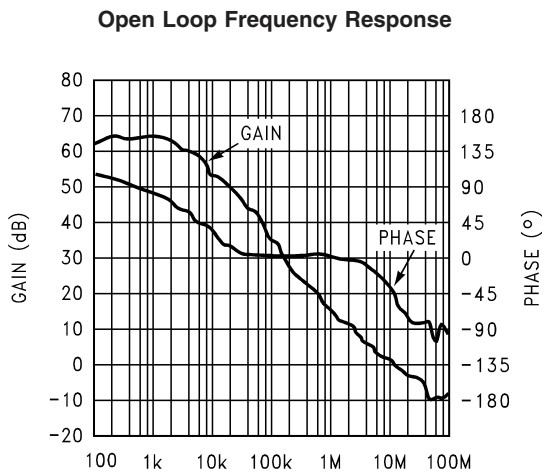

20013784

# Typical Performance Characteristics

## Non-LD Specific Characteristics (Continued)

**Power Derating Curve**

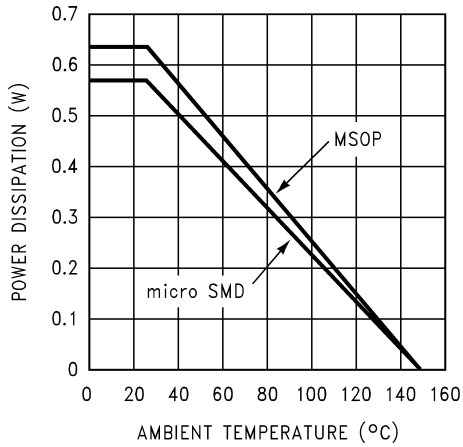

20013776

**Noise Floor**

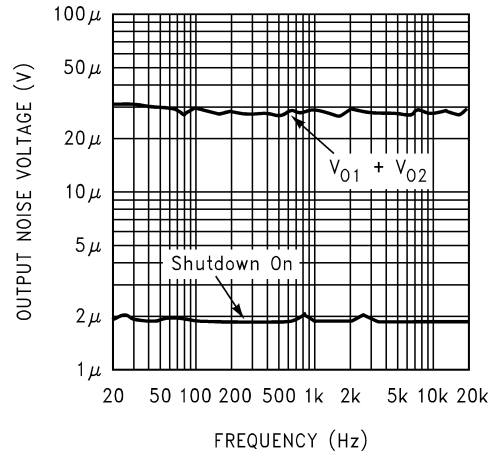

20013777

**Input CMRR vs Frequency**

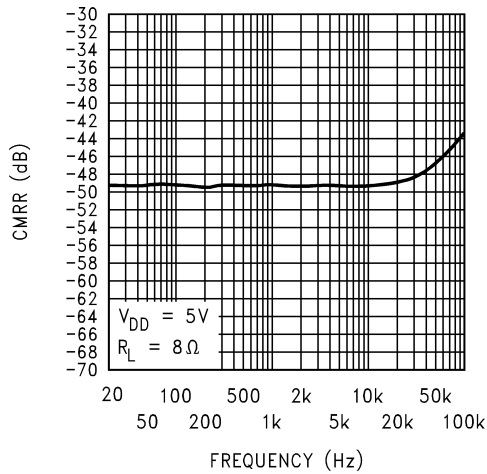

20013778

**Input CMRR vs Frequency**

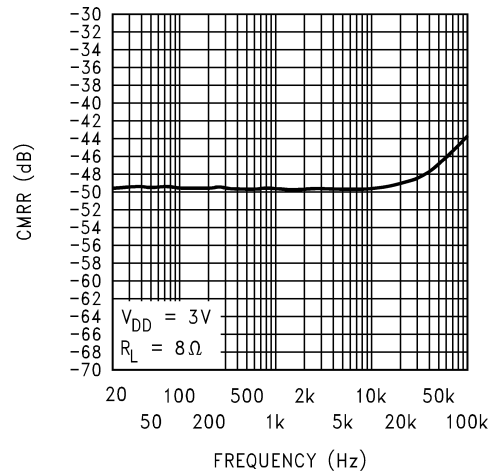

20013779

## Typical Performance Characteristics

### Non-LD Specific Characteristics (Continued)

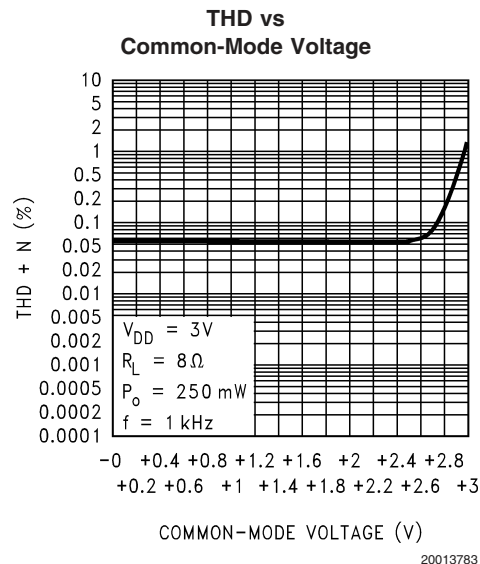
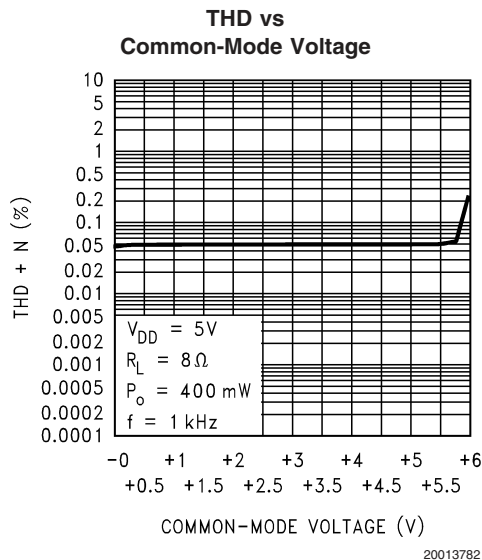
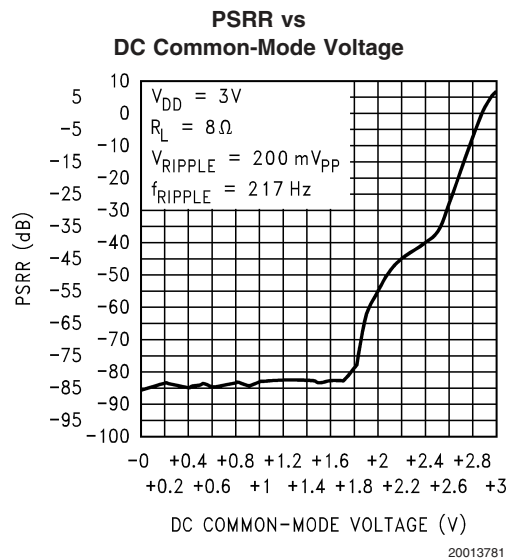
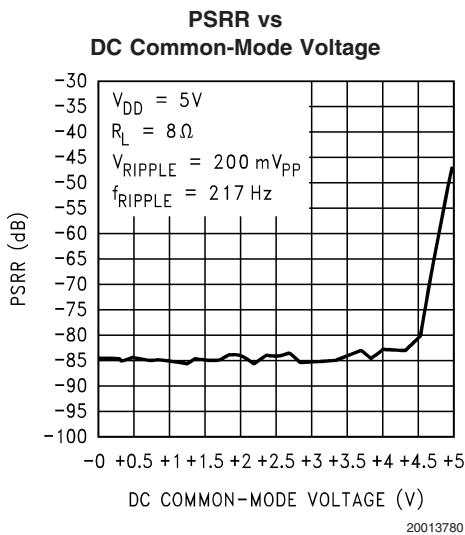

## Application Information

### DIFFERENTIAL AMPLIFIER EXPLANATION

The LM4894 is a fully differential audio amplifier that features differential input and output stages. Internally this is accomplished by two circuits: a differential amplifier and a common mode feedback amplifier that adjusts the output voltages so that the average value remains  $V_{DD}/2$ . When setting the differential gain, the amplifier can be considered to have "halves". Each half uses an input and feedback resistor ( $R_{i1}$  and  $R_{F1}$ ) to set its respective closed-loop gain (see Figure 1). With  $R_{i1} = R_{i2}$  and  $R_{F1} = R_{F2}$ , the gain is set at  $-R_F/R_i$  for each half. This results in a differential gain of

$$A_{VD} = -R_F/R_i \quad (1)$$

It is extremely important to match the input resistors to each other, as well as the feedback resistors to each other for best

amplifier performance. See the **Proper Selection of External Components** section for more information. A differential amplifier works in a manner where the difference between the two input signals is amplified. In most applications, this would require input signals that are  $180^\circ$  out of phase with each other. The LM4894 can be used, however, as a single ended input amplifier while still retaining its fully differential benefits. In fact, completely unrelated signals may be placed on the input pins. The LM4894 simply amplifies the difference between them. Figures 2 and 3 show single-ended applications of the LM4894 that still take advantage of the differential nature of the amplifier and the benefits to PSRR, common-mode noise reduction, and "click and pop" reduction.

All of these applications, either single-ended or fully differential, provide what is known as a "bridged mode" output (bridge-tied-load, BTL). This results in output signals at  $V_{o1}$  and  $V_{o2}$  that are  $180^\circ$  out of phase with respect to each

## Application Information (Continued)

other. Bridged mode operation is different from the single-ended amplifier configuration that connects the load between the amplifier output and ground. A bridged amplifier design has distinct advantages over the single-ended configuration: it provides differential drive to the load, thus doubling maximum possible output swing for a specific supply voltage. Four times the output power is possible compared with a single-ended amplifier under the same conditions. This increase in attainable output power assumes that the amplifier is not current limited or clipped. In order to choose an amplifier's closed-loop gain without causing excess clipping, please refer to the **Audio Power Amplifier Design** section.

A bridged configuration, such as the one used in the LM4894, also creates a second advantage over single-ended amplifiers. Since the differential outputs,  $V_{o1}$  and  $V_{o2}$ , are biased at half-supply, no net DC voltage exists across the load. This assumes that the input resistor pair and the feedback resistor pair are properly matched (see **Proper Selection of External Components**). BTL configuration eliminates the output coupling capacitor required in single-supply, single-ended amplifier configurations. If an output coupling capacitor is not used in a single-ended output configuration, the half-supply bias across the load would result in both increased internal IC power dissipation as well as permanent loudspeaker damage. Further advantages of bridged mode operation specific to fully differential amplifiers like the LM4894 include increased power supply rejection ratio, common-mode noise reduction, and click and pop reduction.

### EXPOSED-DAP PACKAGE PCB MOUNTING CONSIDERATIONS

The LM4894's exposed-DAP (die attach paddle) package (LD) provide a low thermal resistance between the die and the PCB to which the part is mounted and soldered. This allows rapid heat transfer from the die to the surrounding PCB copper traces, ground plane and, finally, surrounding air. The result is a low voltage audio power amplifier that produces 1.4W at  $\leq 1\%$  THD with a  $4\Omega$  load. This high power is achieved through careful consideration of necessary thermal design. Failing to optimize thermal design may compromise the LM4894's high power performance and activate unwanted, though necessary, thermal shutdown protection. The LD package must have its DAP soldered to a copper pad on the PCB. The DAP's PCB copper pad is connected to a large plane of continuous unbroken copper. This plane forms a thermal mass and heat sink and radiation area. Place the heat sink area on either outside plane in the case of a two-sided PCB, or on an inner layer of a board with more than two layers. Connect the DAP copper pad to the inner layer or backside copper heat sink area with 4 (2x2) vias. The via diameter should be 0.012in - 0.013in with a 0.050in pitch. Ensure efficient thermal conductivity by plating-through and solder-filling the vias.

Best thermal performance is achieved with the largest practical copper heat sink area. If the heatsink and amplifier share the same PCB layer, a nominal  $2.5\text{in}^2$  (min) area is necessary for 5V operation with a  $4\Omega$  load. Heatsink areas not placed on the same PCB layer as the LM4894 should be  $5\text{in}^2$  (min) for the same supply voltage and load resistance. The last two area recommendations apply for  $25^\circ\text{C}$  ambient

temperature. In all circumstances and conditions, the junction temperature must be held below  $150^\circ\text{C}$  to prevent activating the LM4894's thermal shutdown protection. The LM4894's power de-rating curve in the Typical Performance Characteristics shows the maximum power dissipation versus temperature. Example PCB layouts for the exposed-DAP TSSOP and LLP packages are shown in the Demonstration Board Layout section. Further detailed and specific information concerning PCB layout, fabrication, and mounting an LLP package is available from National Semiconductor's package Engineering Group under application note AN1187.

### PCB LAYOUT AND SUPPLY REGULATION CONSIDERATIONS FOR DRIVING $3\Omega$ AND $4\Omega$ LOADS

Power dissipated by a load is a function of the voltage swing across the load and the load's impedance. As load impedance decreases, load dissipation becomes increasingly dependent on the interconnect (PCB trace and wire) resistance between the amplifier output pins and the load's connections. Residual trace resistance causes a voltage drop, which results in power dissipated in the trace and not in the load as desired. For example,  $0.1\Omega$  trace resistance reduces the output power dissipated by a  $4\Omega$  load from 1.4W to 1.37W. This problem of decreased load dissipation is exacerbated as load impedance decreases. Therefore, to maintain the highest load dissipation and widest output voltage swing, PCB traces that connect the output pins to a load must be as wide as possible.

Poor power supply regulation adversely affects maximum output power. A poorly regulated supply's output voltage decreases with increasing load current. Reduced supply voltage causes decreased headroom, output signal clipping, and reduced output power. Even with tightly regulated supplies, trace resistance creates the same effects as poor supply regulation. Therefore, making the power supply traces as wide as possible helps maintain full output voltage swing.

### POWER DISSIPATION

Power dissipation is a major concern when designing a successful amplifier, whether the amplifier is bridged or single-ended. Equation 2 states the maximum power dissipation point for a single-ended amplifier operating at a given supply voltage and driving a specified output load.

$$P_{\text{DMAX}} = (V_{\text{DD}})^2 / (2\pi^2 R_L) \text{ Single-Ended} \quad (2)$$

However, a direct consequence of the increased power delivered to the load by a bridge amplifier is an increase in internal power dissipation versus a single-ended amplifier operating at the same conditions.

$$P_{\text{DMAX}} = 4 * (V_{\text{DD}})^2 / (2\pi^2 R_L) \text{ Bridge Mode} \quad (3)$$

Since the LM4894 has bridged outputs, the maximum internal power dissipation is 4 times that of a single-ended amplifier. Even with this substantial increase in power dissipation, the LM4894 does not require additional heatsinking under most operating conditions and output loading. From Equation 3, assuming a 5V power supply and an  $8\Omega$  load, the maximum power dissipation point is 625mW. The maxi-

## Application Information (Continued)

imum power dissipation point obtained from Equation 3 must not be greater than the power dissipation results from Equation 4:

$$P_{\text{DMAX}} = (T_{\text{JMAX}} - T_{\text{A}})/\theta_{\text{JA}} \quad (4)$$

The LM4894's  $\theta_{\text{JA}}$  in an MUA10A package is 190°C/W. Depending on the ambient temperature,  $T_{\text{A}}$ , of the system surroundings, Equation 4 can be used to find the maximum internal power dissipation supported by the IC packaging. If the result of Equation 3 is greater than that of Equation 4, then either the supply voltage must be decreased, the load impedance increased, the ambient temperature reduced, or the  $\theta_{\text{JA}}$  reduced with heatsinking. In many cases, larger traces near the output,  $V_{\text{DD}}$ , and GND pins can be used to lower the  $\theta_{\text{JA}}$ . The larger areas of copper provide a form of heatsinking allowing higher power dissipation. For the typical application of a 5V power supply, with an 8Ω load, the maximum ambient temperature possible without violating the maximum junction temperature is approximately 30°C provided that device operation is around the maximum power dissipation point. Recall that internal power dissipation is a function of output power. If typical operation is not around the maximum power dissipation point, the LM4894 can operate at higher ambient temperatures. Refer to the **Typical Performance Characteristics** curves for power dissipation information.

### POWER SUPPLY BYPASSING

As with any power amplifier, proper supply bypassing is critical for low noise performance and high power supply rejection ratio (PSRR). The capacitor location on both the bypass and power supply pins should be as close to the device as possible. A larger half-supply bypass capacitor improves PSRR because it increases half-supply stability. Typical applications employ a 5V regulator with 10μF and 0.1μF bypass capacitors that increase supply stability. This, however, does not eliminate the need for bypassing the supply nodes of the LM4894. Although the LM4894 will operate without the bypass capacitor  $C_{\text{B}}$ , although the PSRR may decrease. A 1μF capacitor is recommended for  $C_{\text{B}}$ . This value maximizes PSRR performance. Lesser values may be used, but PSRR decreases at frequencies below 1kHz. The issue of  $C_{\text{B}}$  selection is thus dependant upon desired PSRR and click and pop performance as explained in the section **Proper Selection of External Components**.

### SHUTDOWN FUNCTION

In order to reduce power consumption while not in use, the LM4894 contains shutdown circuitry that is used to turn off the amplifier's bias circuitry. In addition, the LM4894 contains a Shutdown Mode pin, allowing the designer to designate whether the part will be driven into shutdown with a high level logic signal or a low level logic signal. This allows the designer maximum flexibility in device use, as the Shutdown Mode pin may simply be tied permanently to either  $V_{\text{DD}}$  or GND to set the LM4894 as either a "shutdown-high" device or a "shutdown-low" device, respectively. The device may then be placed into shutdown mode by toggling the Shutdown Select pin to the same state as the Shutdown Mode pin. For simplicity's sake, this is called "shutdown same", as the LM4894 enters shutdown mode whenever the two pins

are in the same logic state. The trigger point for either shutdown high or shutdown low is shown as a typical value in the Supply Current vs Shutdown Voltage graphs in the **Typical Performance Characteristics** section. It is best to switch between ground and supply for maximum performance. While the device may be disabled with shutdown voltages in between ground and supply, the idle current may be greater than the typical value of 0.1μA. In either case, the shutdown pin should be tied to a definite voltage to avoid unwanted state changes.

In many applications, a microcontroller or microprocessor output is used to control the shutdown circuitry, which provides a quick, smooth transition to shutdown. Another solution is to use a single-throw switch in conjunction with an external pull-up resistor (or pull-down, depending on shutdown high or low application). This scheme guarantees that the shutdown pin will not float, thus preventing unwanted state changes.

### PROPER SELECTION OF EXTERNAL COMPONENTS

Proper selection of external components in applications using integrated power amplifiers is critical when optimizing device and system performance. Although the LM4894 is tolerant to a variety of external component combinations, consideration of component values must be made when maximizing overall system quality.

The LM4894 is unity-gain stable, giving the designer maximum system flexibility. The LM4894 should be used in low closed-loop gain configurations to minimize THD+N values and maximize signal to noise ratio. Low gain configurations require large input signals to obtain a given output power. Input signals equal to or greater than 1Vrms are available from sources such as audio codecs. Please refer to the Audio Power Amplifier Design section for a more complete explanation of proper gain selection. When used in its typical application as a fully differential power amplifier the LM4894 does not require input coupling capacitors for input sources with DC common-mode voltages of less than  $V_{\text{DD}}$ . Exact allowable input common-mode voltage levels are actually a function of  $V_{\text{DD}}$ ,  $R_{\text{i}}$ , and  $R_{\text{f}}$  and may be determined by Equation 5:

$$V_{\text{CMi}} < (V_{\text{DD}} - 1.2) * ((R_{\text{f}} + (R_{\text{i}})/(R_{\text{f}}) - V_{\text{DD}} * (R_{\text{f}}/2R_{\text{f}})) \quad (5)$$

$$V_{\text{CMi}} < (V_{\text{DD}} - 1.2) * ((R_{\text{f}} + (R_{\text{i}})/(R_{\text{f}}) - V_{\text{DD}} * (R_{\text{f}}/2R_{\text{f}})) \quad (6)$$

Special care must be taken to match the values of the feedback resistors ( $R_{\text{F1}}$  and  $R_{\text{F2}}$ ) to each other as well as matching the input resistors ( $R_{\text{I1}}$  and  $R_{\text{I2}}$ ) to each other (see Figure 1) more in front. Because of the balanced nature of differential amplifiers, resistor matching differences can result in net DC currents across the load. This DC current can increase power consumption, internal IC power dissipation, reduce PSRR, and possibly damaging the loudspeaker. The chart below demonstrates this problem by showing the effects of differing values between the feedback resistors while assuming that the input resistors are perfectly matched. The results below apply to the application circuit shown in Figure 1, and assumes that  $V_{\text{DD}} = 5\text{V}$ ,  $R_{\text{L}} = 8\Omega$ , and the system has DC coupled inputs tied to ground.

## Application Information (Continued)

Tolerance	R <sub>F1</sub>	R <sub>F2</sub>	V <sub>O2</sub> - V <sub>O1</sub>	I <sub>LOAD</sub>
20%	0.8R	1.2R	-0.500V	62.5mA
10%	0.9R	1.1R	-0.250V	31.25mA
5%	0.95R	1.05R	-0.125V	15.63mA
1%	0.99R	1.01R	-0.025V	3.125mA
0%	R	R	0	0

Similar results would occur if the input resistors were not carefully matched. Adding input coupling capacitors in between the signal source and the input resistors will eliminate this problem, however, to achieve best performance with minimum component count it is highly recommended that both the feedback and input resistors matched to 1% tolerance or better.

### AUDIO POWER AMPLIFIER DESIGN

#### Design a 1W/8Ω Audio Amplifier

Given:

Power Output	1Wrms
Load Impedance	8Ω
Input Level	1Vrms
Input Impedance	20kΩ
Bandwidth	-20kHz ± 0.25dB

A designer must first determine the minimum supply rail to obtain the specified output power. The supply rail can easily be found by extrapolating from the Output Power vs Supply Voltage graphs in the **Typical Performance Characteristics** section. A second way to determine the minimum supply rail is to calculate the required VOPEAK using Equation 7 and add the dropout voltages. Using this method, the minimum supply voltage is (V<sub>opeak</sub> + (V<sub>DO TOP</sub> + (V<sub>DO BOT</sub>))), where V<sub>DO BOT</sub> and V<sub>DO TOP</sub> are extrapolated from the Dropout Voltage vs Supply Voltage curve in the **Typical Performance Characteristics** section.

$$V_{\text{opeak}} = \sqrt{(2R_L P_O)} \quad (7)$$

Using the Output Power vs Supply Voltage graph for an 8W load, the minimum supply rail just about 5V. Extra supply voltage creates headroom that allows the LM4894 to reproduce peaks in excess of 1W without producing audible distortion. At this time, the designer must make sure that the power supply choice along with the output impedance does not violate the conditions explained in the **Power Dissipation** section. Once the power dissipation equations have been addressed, the required differential gain can be determined from Equation 7.

$$A_{VD} \geq \sqrt{(P_O R_L)} / (V_{IN}) = V_{\text{orms}} / V_{\text{inrms}} \quad (8)$$

$$R_f / R_i = A_{VD}$$

From Equation 7, the minimum A<sub>VD</sub> is 2.83. Since the desired input impedance was 20kΩ, a ratio of 2.83:1 of R<sub>f</sub> to R<sub>i</sub> results in an allocation of R<sub>f</sub> = 20kΩ for both input resistors and R<sub>f</sub> = 60kΩ for both feedback resistors. The final design step is to address the bandwidth requirement which must be stated as a single -3dB frequency point. Five times away from a -3dB point is 0.17dB down from passband response which is better than the required ±0.25dB specified.

$$f_H = 20\text{kHz} * 5 = 100\text{kHz}$$

The high frequency pole is determined by the product of the desired frequency pole, f<sub>H</sub>, and the differential gain, A<sub>VD</sub>. With a A<sub>VD</sub> = 2.83 and f<sub>H</sub> = 100kHz, the resulting GBWP = 150kHz which is much smaller than the LM4894 GBWP of 10MHz. This figure displays that if a designer has a need to design an amplifier with a higher differential gain, the LM4894 can still be used without running into bandwidth limitations.

## Application Information (Continued)

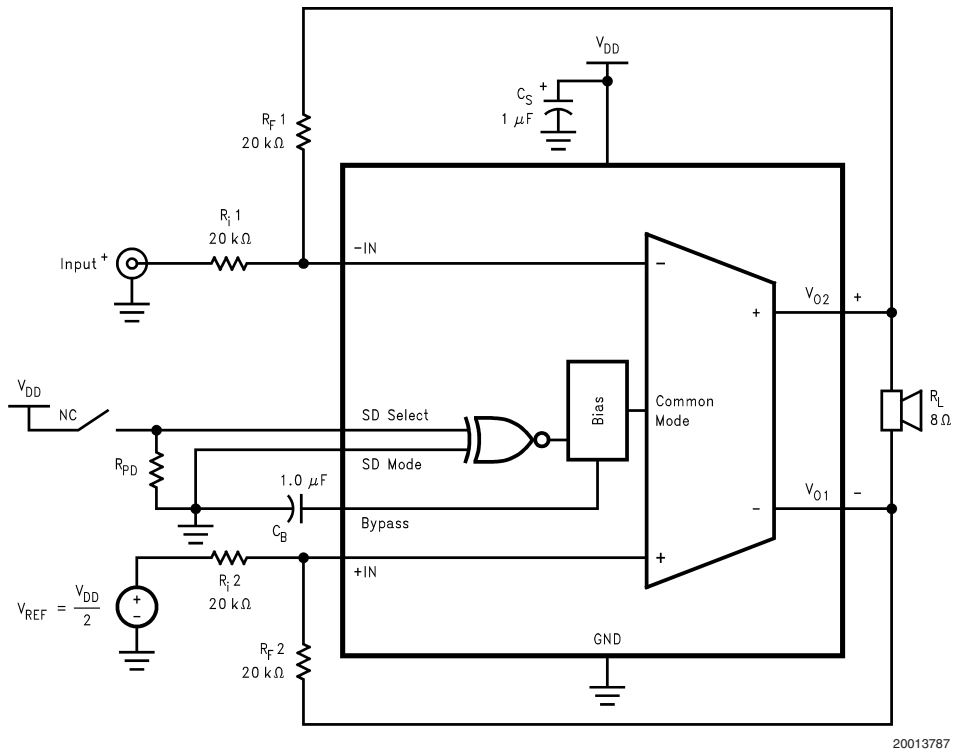

FIGURE 2. Single-Ended Input, "Shutdown-Low" Configuration

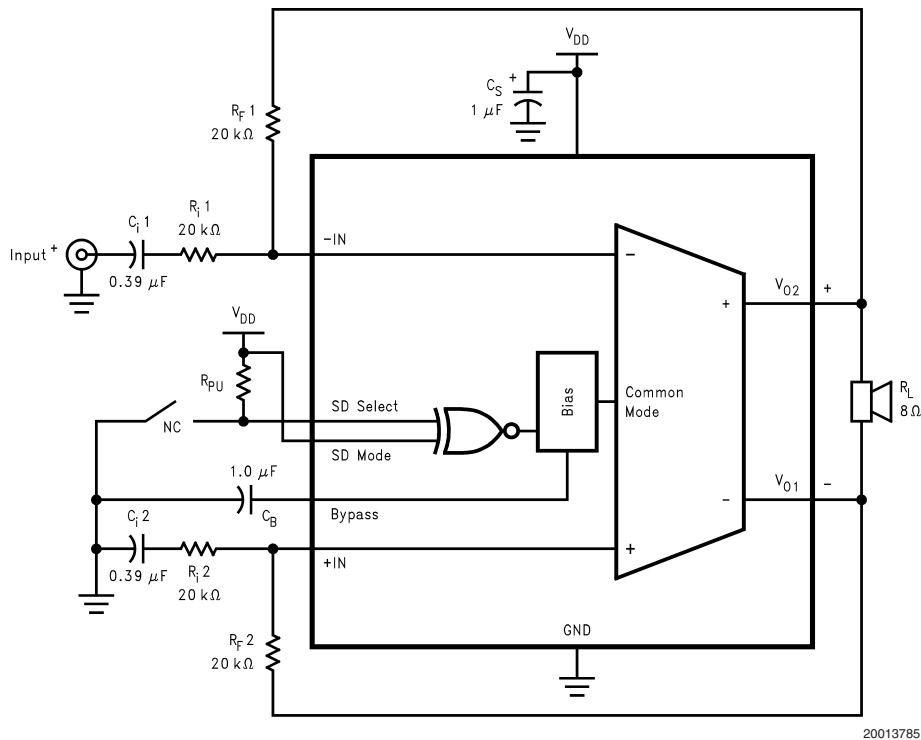
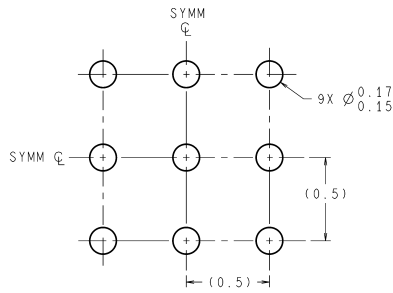

FIGURE 3. Single-Ended Input, "Shutdown-High" Configuration

**Physical Dimensions** inches (millimeters) unless otherwise noted



DIMENSIONS ARE IN MILLIMETERS

**LAND PATTERN RECOMMENDATION**

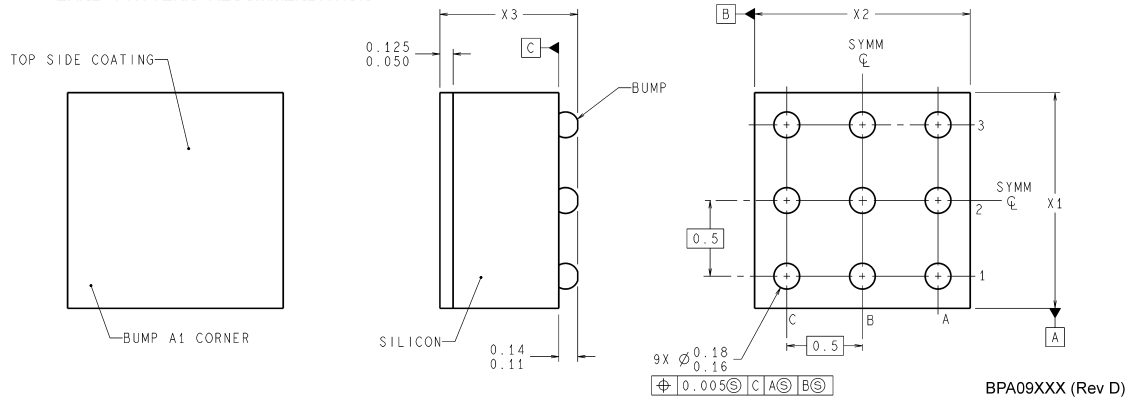

BPA09XXX (Rev D)

**9-Bump micro SMD**  
**Order Number LM4894IBP**  
**NS Package Number BPA09CDB**  
**X1 = 1.336±0.03 X2 = 1.361±0.03 X3 = 0.850±0.10**



**Physical Dimensions** inches (millimeters) unless otherwise noted (Continued)

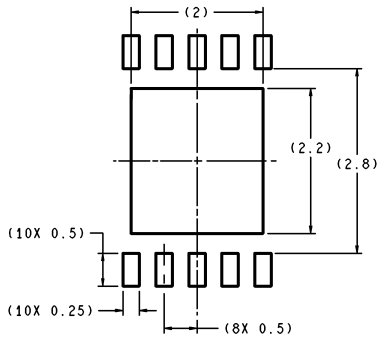

DIMENSIONS ARE IN MILLIMETERS

RECOMMENDED LAND PATTERN  
1:1 RATIO WITH PKG SOLDER PADS

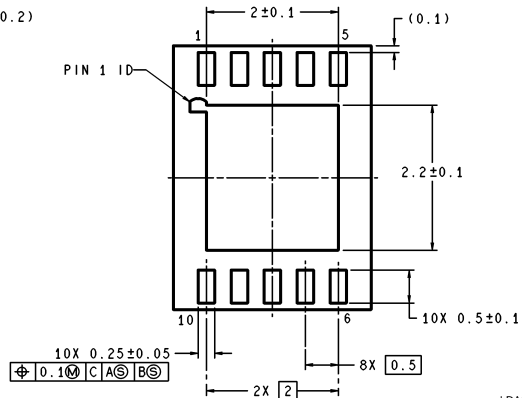
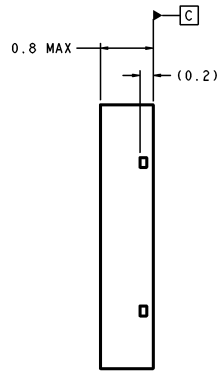
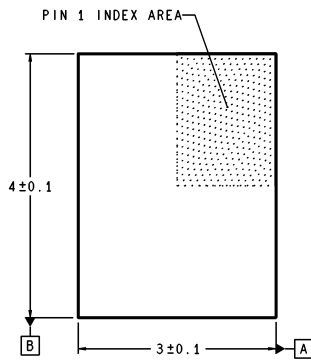

LDA10B (Rev A)

**LLP**  
**Order Number LM4894LD**  
**NSPackage Number LDA10B**

**Physical Dimensions** inches (millimeters) unless otherwise noted (Continued)

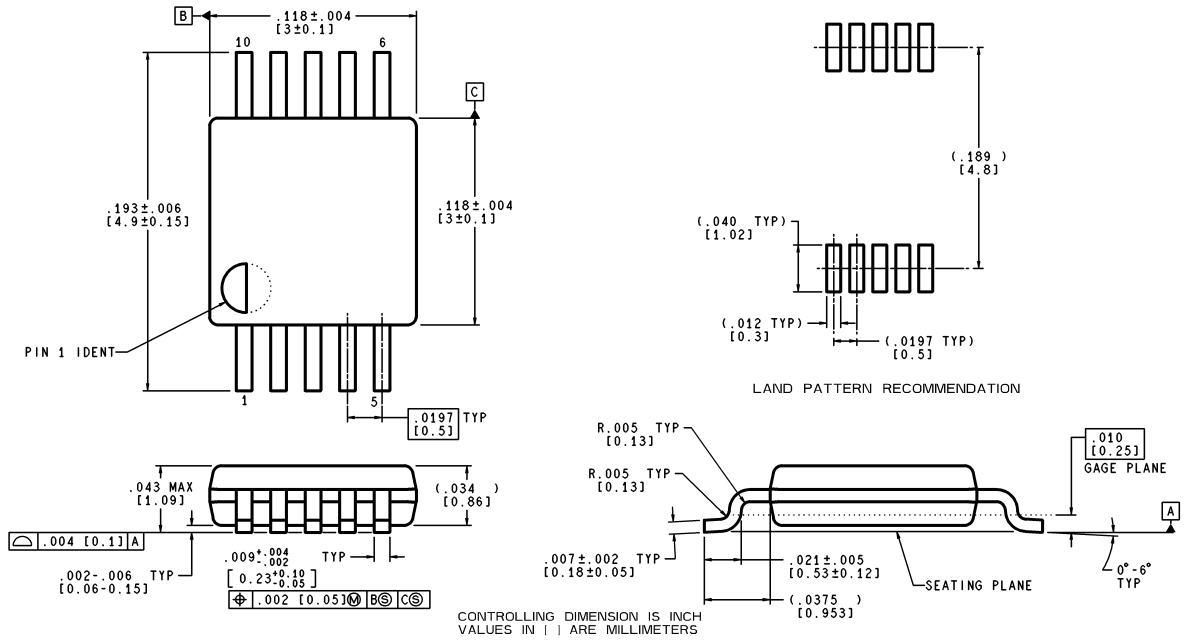

MUB10A (Rev A)

**Mini Small Outline (MSOP)**  
**Order Number LM4894MM**  
**NSPackage Number MUB10A**

**Physical Dimensions** inches (millimeters) unless otherwise noted (Continued)

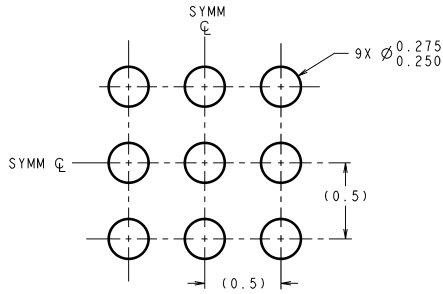

DIMENSIONS ARE IN MILLIMETERS

**LAND PATTERN RECOMMENDATION**

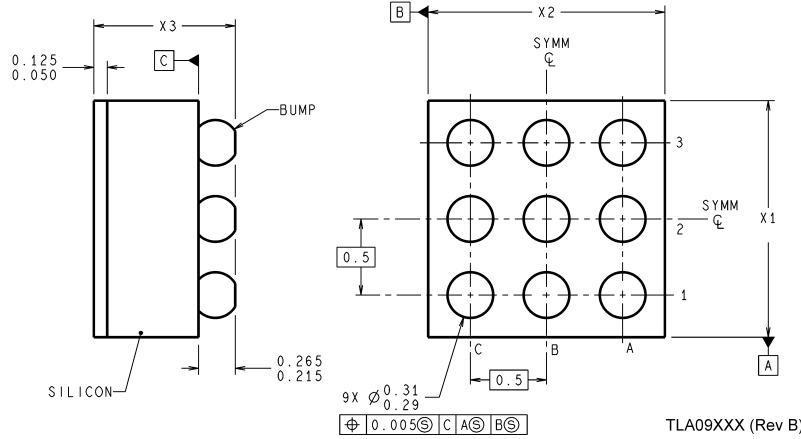
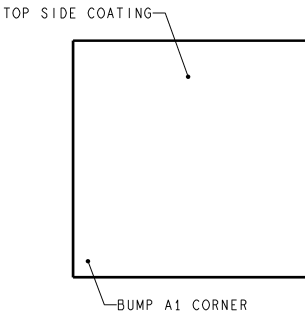

TLA09XXX (Rev B)

**9-Bump micro SMD**  
**Order Number LM4894ITL, LM4894ITLX**  
**NS Package Number TLA09AAA**  
**X1 = 1.514±0.03 X2 = 1.514±0.03 X3 = 0.600±0.075**

**LIFE SUPPORT POLICY**

NATIONAL'S PRODUCTS ARE NOT AUTHORIZED FOR USE AS CRITICAL COMPONENTS IN LIFE SUPPORT DEVICES OR SYSTEMS WITHOUT THE EXPRESS WRITTEN APPROVAL OF THE PRESIDENT AND GENERAL COUNSEL OF NATIONAL SEMICONDUCTOR CORPORATION. As used herein:

1. Life support devices or systems are devices or systems which, (a) are intended for surgical implant into the body, or (b) support or sustain life, and whose failure to perform when properly used in accordance with instructions for use provided in the labeling, can be reasonably expected to result in a significant injury to the user.
2. A critical component is any component of a life support device or system whose failure to perform can be reasonably expected to cause the failure of the life support device or system, or to affect its safety or effectiveness.



**National Semiconductor**  
**Americas Customer Support Center**  
 Email: new.feedback@nsc.com  
 Tel: 1-800-272-9959

**National Semiconductor**  
**Europe Customer Support Center**  
 Fax: +49 (0) 180-530 85 86  
 Email: europe.support@nsc.com  
 Deutsch Tel: +49 (0) 69 9508 6208  
 English Tel: +44 (0) 870 24 0 2171  
 Français Tel: +33 (0) 1 41 91 8790

**National Semiconductor**  
**Asia Pacific Customer Support Center**  
 Email: ap.support@nsc.com

**National Semiconductor**  
**Japan Customer Support Center**  
 Fax: 81-3-5639-7507  
 Email: jpn.feedback@nsc.com  
 Tel: 81-3-5639-7560

www.national.com