

# LM4809 Boomer® Audio Power Amplifier Series

## Dual 105mW Headphone Amplifier with Active-Low Shutdown Mode

### General Description

The LM4809 is a dual audio power amplifier capable of delivering 105mW per channel of continuous average power into a 16Ω load with 0.1% (THD+N) from a 5V power supply.

Boomer audio power amplifiers were designed specifically to provide high quality output power with a minimal amount of external components. Since the LM4809 does not require bootstrap capacitors or snubber networks, it is optimally suited for low-power portable systems.

The unity-gain stable LM4809 can be configured by external gain-setting resistors.

The LM4809 features an externally controlled, active-low, micropower consumption shutdown mode, as well as an internal thermal shutdown protection mechanism.

### Key Specifications

- THD+N at 1kHz at 105mW continuous average power into 16Ω 0.1% (typ)
- THD+N at 1kHz at 70mW continuous average power into 32Ω 0.1% (typ)
- Shutdown Current 0.4μA (typ)

### Features

- Active-low shutdown mode
- "Click and Pop" reduction circuitry
- Low shutdown current
- LLP, MSOP, and SO surface mount packaging
- No bootstrap capacitors required
- Unity-gain stable

### Applications

- Headphone Amplifier
- Personal Computers
- Microphone Preamplifier
- PDA's

### Typical Application

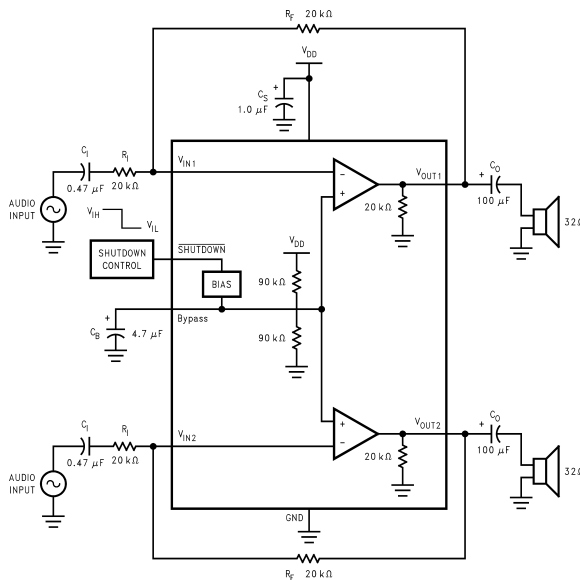

\*Refer to the **Application Information** Section for information concerning proper selection of the input and output coupling capacitors.

**FIGURE 1. Typical Audio Amplifier Application Circuit**

Boomer® is a registered trademark of National Semiconductor Corporation.

# Connection Diagrams

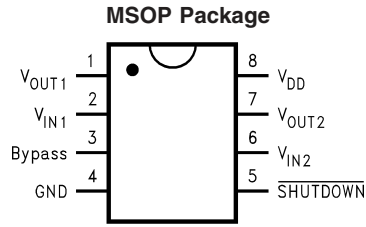

20009002

**Top View**  
**Order Number LM4809MM**  
**See NS Package Number MUA08A**

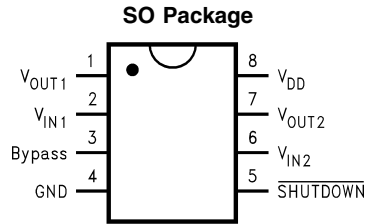

20009002

**Top View**  
**Order Number LM4809MA**  
**See NS Package Number M08A**

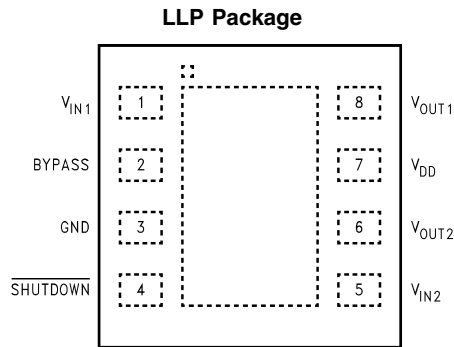

20009061

**Top View**  
**Order Number LM4809LD**  
**See NS Package Number LDA08B**

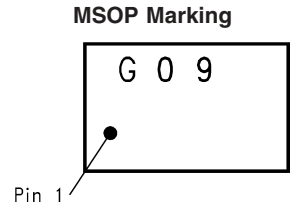

20009066

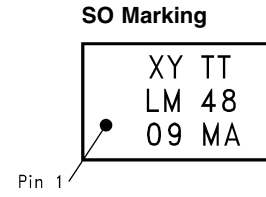

20009067

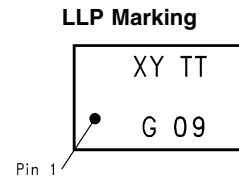

20009068

**Absolute Maximum Ratings** (Note 2)

If Military/Aerospace specified devices are required, please contact the National Semiconductor Sales Office/Distributors for availability and specifications.

Supply Voltage	6.0V
Storage Temperature	-65°C to +150°C
ESD Susceptibility (Note 4)	3.5kV
ESD Machine model (Note 8)	250V
Junction Temperature (T <sub>J</sub> )	150°C
Soldering Information (Note 1)	
Small Outline Package	
Vapor Phase (60 sec.)	215°C
Infrared (15 sec.)	220°C

## Thermal Resistance

θ <sub>JA</sub> (SO)	170°C/W
θ <sub>JC</sub> (SO)	35°C/W
θ <sub>JA</sub> (MSOP)	210°C/W
θ <sub>JC</sub> (MSOP)	56°C/W
θ <sub>JA</sub> (LLP)	117°C/W (Note 9)
θ <sub>JA</sub> (LLP)	150°C/W (Note 10)
θ <sub>JC</sub> (LLP)	15°C/W

**Operating Ratings**

## Temperature Range

$$T_{\text{MIN}} \leq T_{\text{A}} \leq T_{\text{MAX}} \quad -40^{\circ}\text{C} \leq T_{\text{A}} \leq 85^{\circ}\text{C}$$

Supply Voltage (V<sub>CC</sub>)

$$2.0\text{V} \leq V_{\text{CC}} \leq 5.5\text{V}$$

**Note 1:** See AN-450 "Surface Mounting and their Effects on Product Reliability" for other methods of soldering surface mount devices.

**Electrical Characteristics** (Notes 2, 3)

The following specifications apply for V<sub>DD</sub> = 5V unless otherwise specified, limits apply to T<sub>A</sub> = 25°C.

Symbol	Parameter	Conditions	LM4809		Units (Limits)
			Typ (Note 5)	Limit (Note 7)	
V <sub>DD</sub>	Supply Voltage			2.0 5.5	V (min) V (max)
I <sub>DD</sub>	Supply Current	V <sub>IN</sub> = 0V, I <sub>O</sub> = 0A	1.4	3	mA (max)
I <sub>SD</sub>	Shutdown Current	V <sub>IN</sub> = 0V, V <sub>SHUTDOWN</sub> = GND	0.4	2	µA(max)
V <sub>OS</sub>	Output Offset Voltage	V <sub>IN</sub> = 0V	4.0	50	mV(max)
P <sub>O</sub>	Output Power	THD+N = 0.1%, f = 1kHz			
		R <sub>L</sub> = 16Ω	105		mW
		R <sub>L</sub> = 32Ω	70	65	mW (min)
THD+N	Total Harmonic Distortion	P <sub>O</sub> = 50mW, R <sub>L</sub> = 32Ω f = 20Hz to 20kHz	0.3		%
Crosstalk	Channel Separation	R <sub>L</sub> = 32Ω; P <sub>O</sub> = 70mW	70		dB
PSRR	Power Supply Rejection Ratio	C <sub>B</sub> = 1.0µF; V <sub>RIPPLE</sub> = 200mV <sub>PP</sub> , f = 1kHz; Input terminated into 50Ω	70		dB
V <sub>SDIH</sub>	Shutdown Voltage Input High			0.8 x V <sub>DD</sub>	V (min)
V <sub>SDIL</sub>	Shutdown Voltage Input Low			0.2 x V <sub>DD</sub>	V (max)

**Electrical Characteristics** (Notes 2, 3)

The following specifications apply for V<sub>DD</sub> = 3.3V unless otherwise specified, limits apply to T<sub>A</sub> = 25°C.

Symbol	Parameter	Conditions	LM4809		Units (Limits)
			Typ (Note 5)	Limit (Note 7)	
I <sub>DD</sub>	Supply Current	V <sub>IN</sub> = 0V, I <sub>O</sub> = 0A	1.1		mA
I <sub>SD</sub>	Shutdown Current	V <sub>IN</sub> = 0V, V <sub>SHUTDOWN</sub> = GND	0.4		µA
V <sub>OS</sub>	Output Offset Voltage	V <sub>IN</sub> = 0V	4.0		mV
P <sub>O</sub>	Output Power	THD+N = 0.1%, f = 1kHz			
		R <sub>L</sub> = 16Ω	40		mW
		R <sub>L</sub> = 32Ω	28		mW
THD+N	Total Harmonic Distortion	P <sub>O</sub> = 25mW, R <sub>L</sub> = 32Ω f = 20Hz to 20kHz	0.4		%
Crosstalk	Channel Separation	R <sub>L</sub> = 32Ω; P <sub>O</sub> = 25mW	70		dB

**Electrical Characteristics** (Notes 2, 3) (Continued)

The following specifications apply for  $V_{DD} = 3.3V$  unless otherwise specified, limits apply to  $T_A = 25^\circ C$ .

Symbol	Parameter	Conditions	LM4809		Units (Limits)
			Typ (Note 5)	Limit (Note 7)	
PSRR	Power Supply Rejection Ratio	$C_B = 1.0\mu F$ ; $V_{RIPPLE} = 200mV_{PP}$ , $f = 1kHz$ ; Input terminated into $50\Omega$	70		dB
$V_{SDIH}$	Shutdown Voltage Input High			$0.8 \times V_{DD}$	V (min)
$V_{SDIL}$	Shutdown Voltage Input Low			$0.2 \times V_{DD}$	V (max)

**Electrical Characteristics** (Notes 2, 3)

The following specifications apply for  $V_{DD} = 2.6V$  unless otherwise specified, limits apply to  $T_A = 25^\circ C$ .

Symbol	Parameter	Conditions	LM4809		Units (Limits)
			Typ (Note 5)	Limit (Note 7)	
$I_{DD}$	Supply Current	$V_{IN} = 0V$ , $I_O = 0A$	0.9		mA
$I_{SD}$	Shutdown Current	$V_{IN} = 0V$ , $V_{SHUTDOWN} = GND$	0.2		$\mu A$
$V_{OS}$	Output Offset Voltage	$V_{IN} = 0V$	4.0		mV
$P_O$	Output Power	THD+N = 0.1%, $f = 1kHz$			
		$R_L = 16\Omega$	20		mW
		$R_L = 32\Omega$	16		mW
THD+N	Total Harmonic Distortion	$P_O = 15mW$ , $R_L = 32\Omega$ $f = 20Hz$ to $20kHz$	0.6		%
Crosstalk	Channel Separation	$R_L = 32\Omega$ ; $P_O = 15mW$	70		dB
PSRR	Power Supply Rejection Ratio	$C_B = 1.0\mu F$ ; $V_{RIPPLE} = 200mV_{PP}$ , $f = 1kHz$ ; Input terminated into $50\Omega$	70		dB
$V_{SDIH}$	Shutdown Voltage Input High			$0.8 \times V_{DD}$	V (min)
$V_{SDIL}$	Shutdown Voltage Input Low			$0.2 \times V_{DD}$	V (max)

**Note 2:** Absolute Maximum Ratings indicate limits beyond which damage to the device may occur.

**Note 3:** All voltages are measured with respect to the ground pin, unless otherwise specified.

**Note 4:** Human body model, 100pF discharged through a 1.5k $\Omega$  resistor.

**Note 5:** Typical specifications are specified at +25 $^\circ C$  and represent the most likely parametric norm.

**Note 6:** Tested limits are guaranteed to National's AOQL (Average Outgoing Quality Level).

**Note 7:** Datasheet min/max specification limits are guaranteed by design, test, or statistical analysis.

**Note 8:** Machine Model ESD test is covered by specification EIAJ IC-121-1981. A 200pF cap is charged to the specified voltage, then discharged directly into the IC with no external series resistor (resistance of discharge path must be under 50 $\Omega$ ).

**Note 9:** The given  $\theta_{JA}$  is for an LM4809 packaged in an LDA08B with the Exposed-Dap soldered to a printed circuit board copper pad with an area equivalent to that of the Exposed-Dap itself.

**Note 10:** The given  $\theta_{JA}$  is for an LM4809 packaged in an LDA08B with the Exposed-Dap not soldered to any printed circuit board copper.

**External Components Description** (Figure 1)

Components	Functional Description
1. $R_i$	The inverting input resistance, along with $R_f$ , set the closed-loop gain. $R_i$ , along with $C_i$ , form a high pass filter with $f_c = 1/(2\pi R_i C_i)$ .
2. $C_i$	The input coupling capacitor blocks DC voltage at the amplifier's input terminals. $C_i$ , along with $R_i$ , create a highpass filter with $f_c = 1/(2\pi R_i C_i)$ . Refer to the section, <b>Selecting Proper External Components</b> , for an explanation of determining the value of $C_i$ .
3. $R_f$	The feedback resistance, along with $R_i$ , set closed-loop gain.
4. $C_S$	This is the supply bypass capacitor. It provides power supply filtering. Refer to the <b>Application Information</b> section for proper placement and selection of the supply bypass capacitor.
5. $C_B$	This is the BYPASS pin capacitor. It provides half-supply filtering. Refer to the section, <b>Selecting Proper External Components</b> , for information concerning proper placement and selection of $C_B$ .
6. $C_O$	This is the output coupling capacitor. It blocks the DC voltage at the amplifier's output and forms a high pass filter with $R_L$ at $f_o = 1/(2\pi R_L C_O)$

# Typical Performance Characteristics

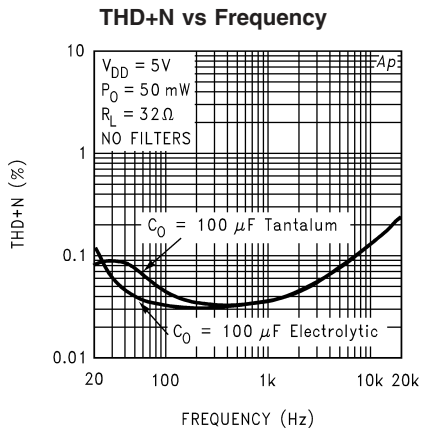

20009003

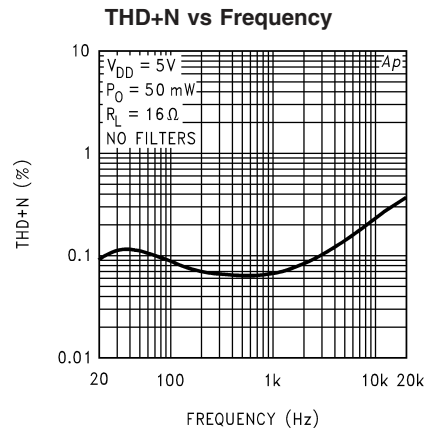

20009004

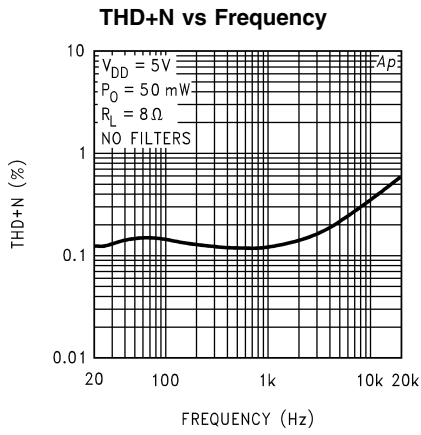

20009005

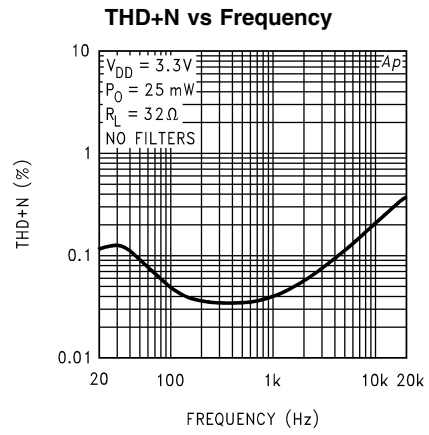

20009006

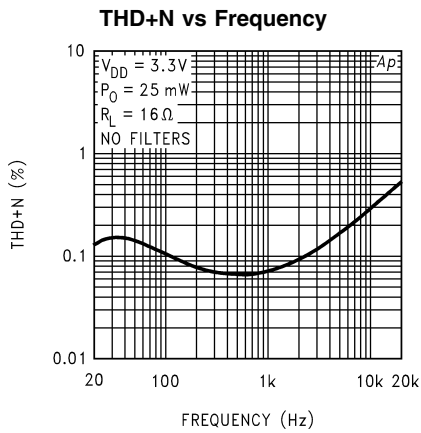

20009007

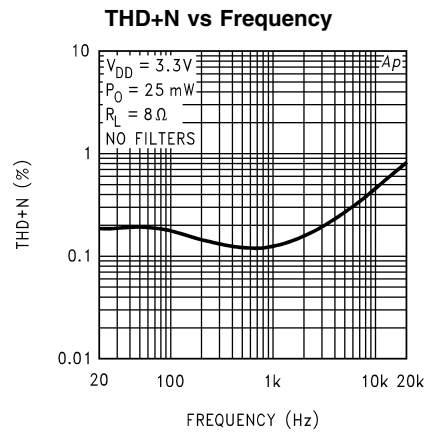

20009008

Typical Performance Characteristics (Continued)

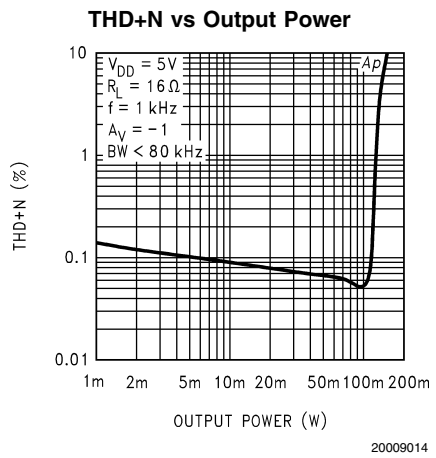
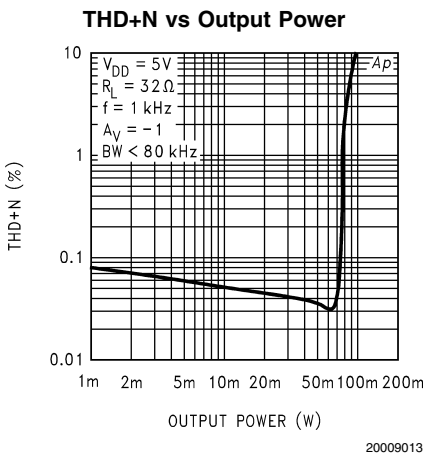
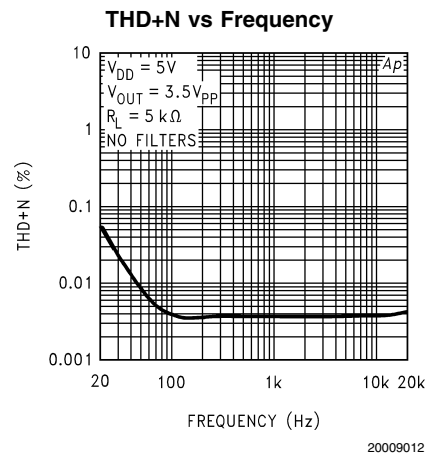
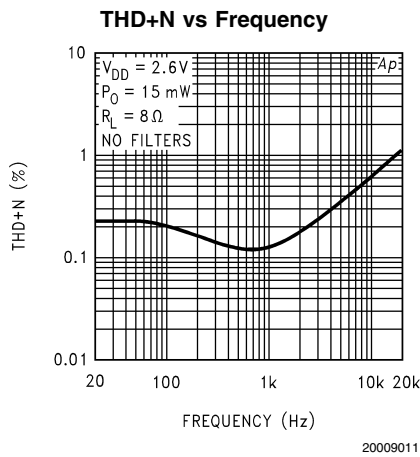
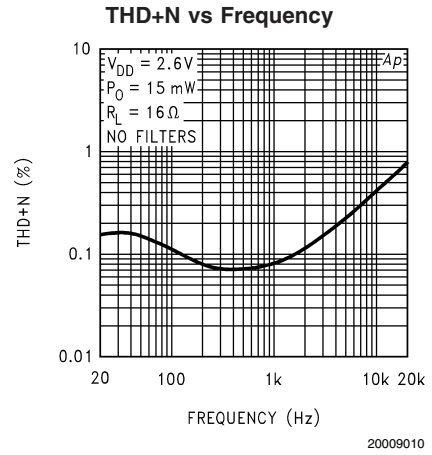
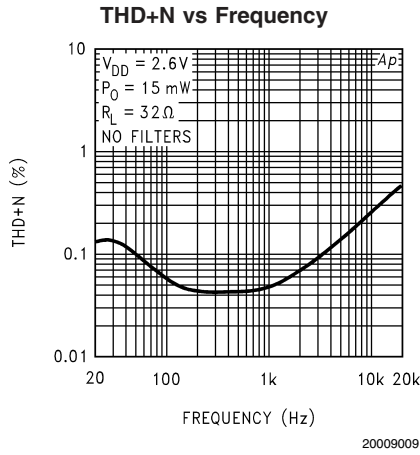

Typical Performance Characteristics (Continued)

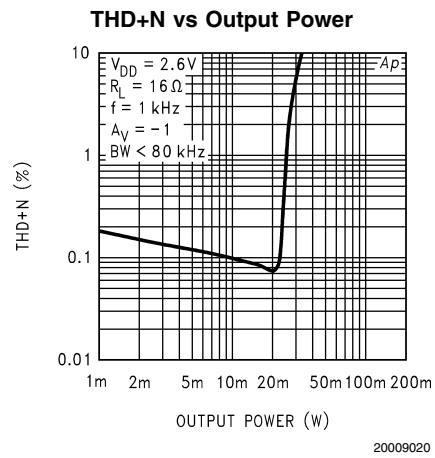
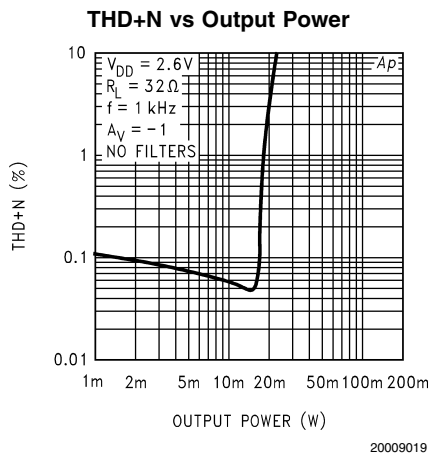
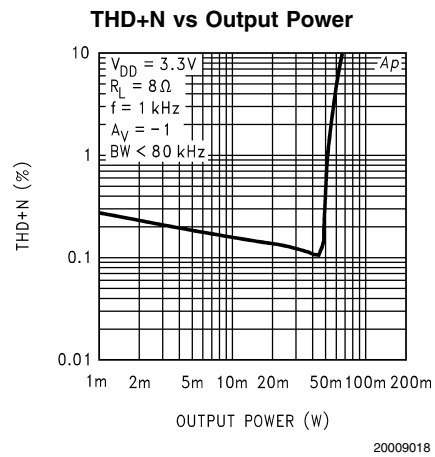
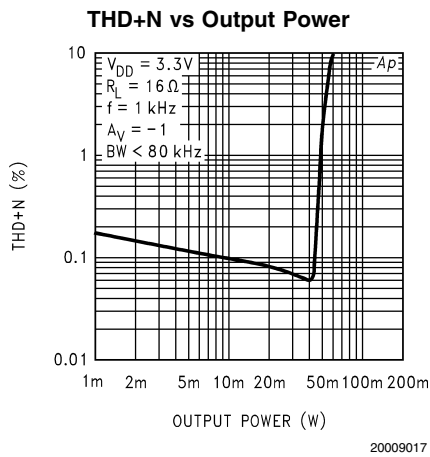
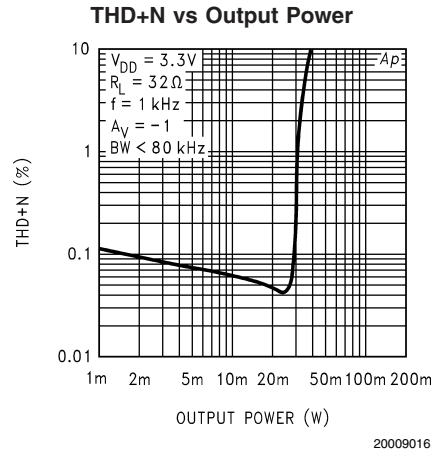
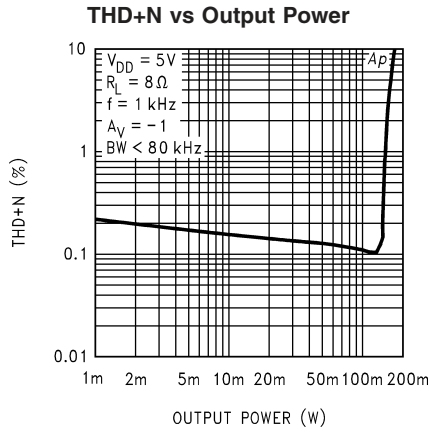

Typical Performance Characteristics (Continued)

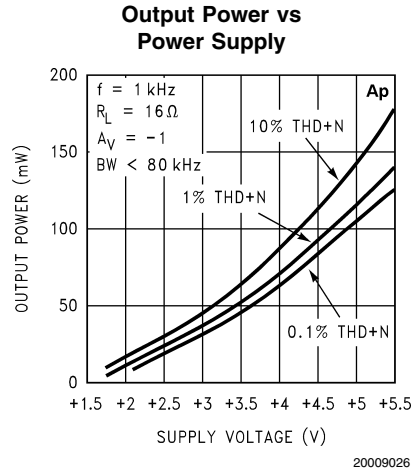
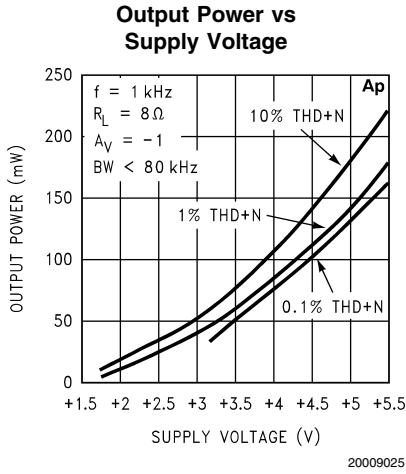
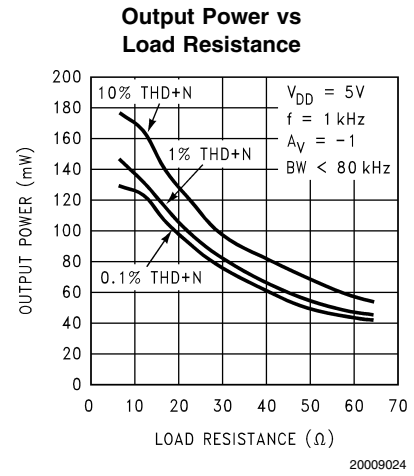
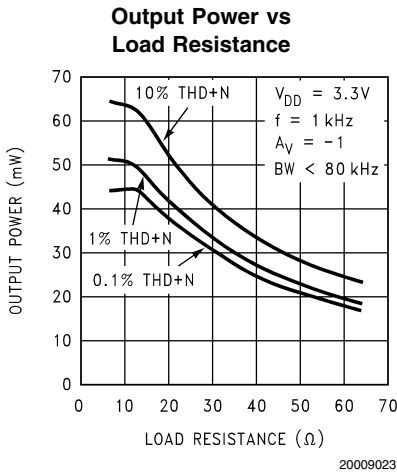
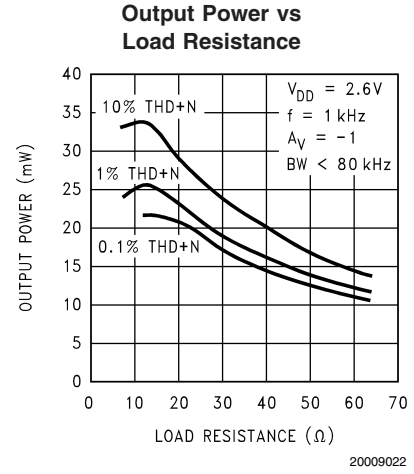
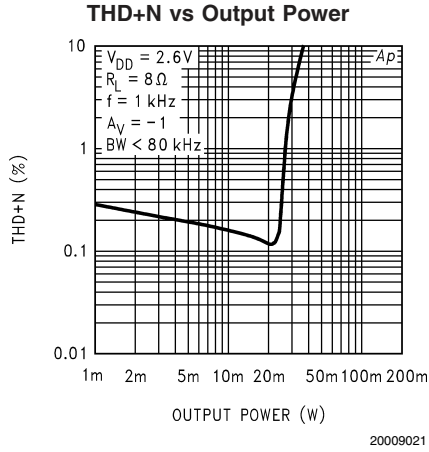



Typical Performance Characteristics (Continued)

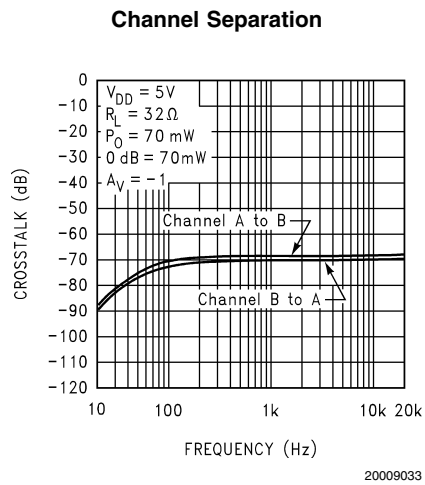
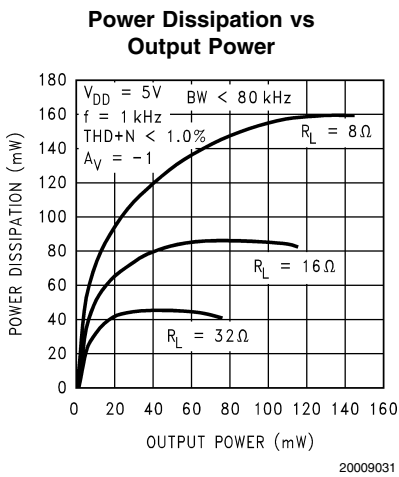
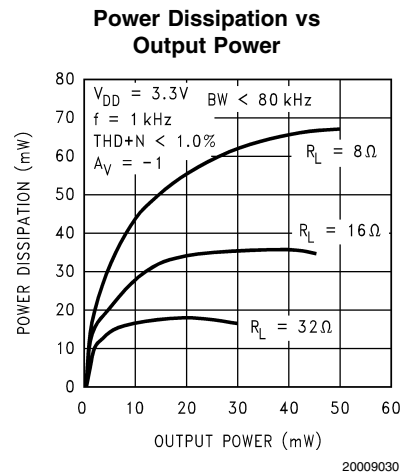
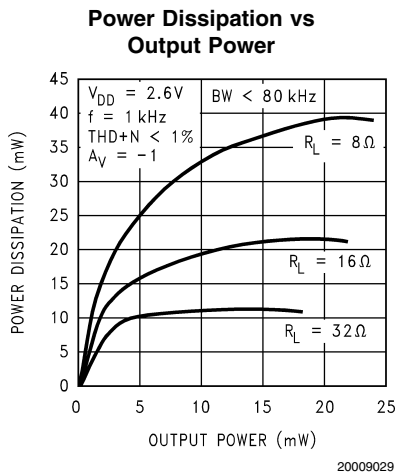
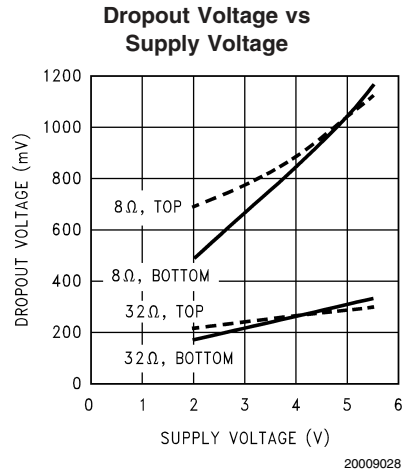
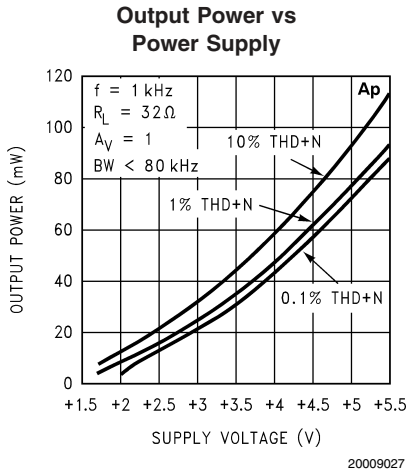

Typical Performance Characteristics (Continued)

Noise Floor

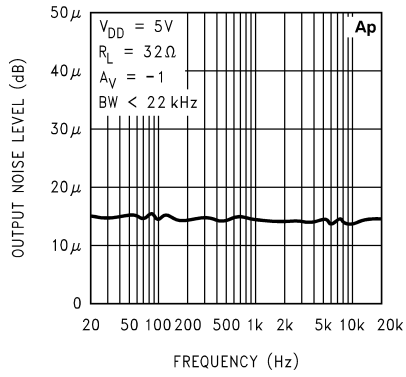

20009034

Power Supply Rejection Ratio

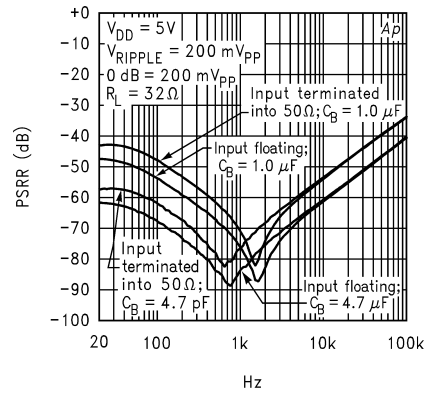

20009035

Open Loop Frequency Response

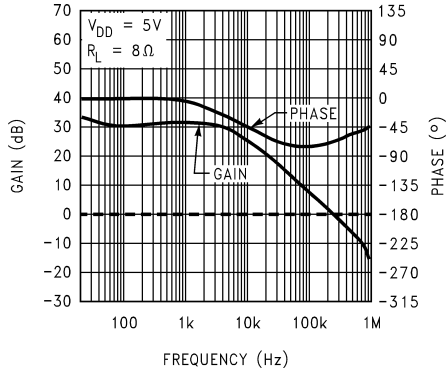

20009050

Open Loop Frequency Response

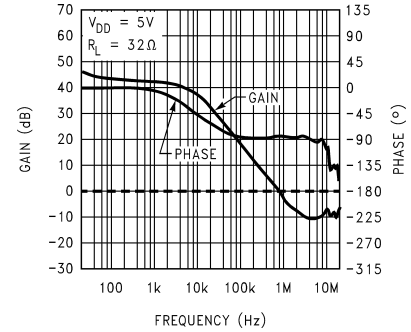

20009051

Open Loop Frequency Response

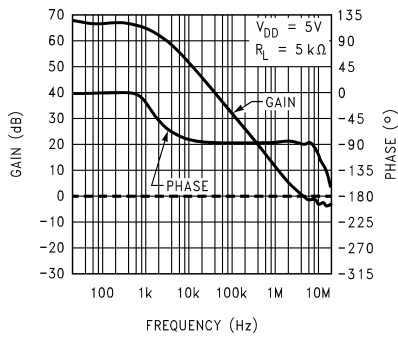

20009038

Supply Current vs Supply Voltage

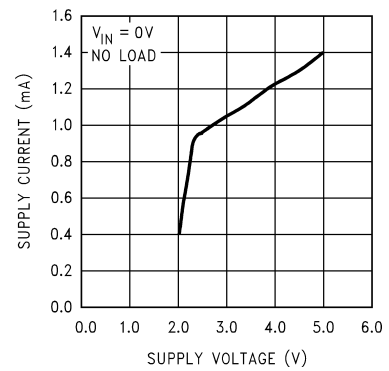

20009044

## Application Information

### MICRO-POWER SHUTDOWN

The voltage applied to the  $\overline{\text{SHUTDOWN}}$  pin controls the LM4809's shutdown function. Activate micro-power shutdown by applying a logic low voltage to the  $\overline{\text{SHUTDOWN}}$  pin. The logic threshold is typically  $V_{DD}/2$ . When active, the LM4809's micro-power shutdown feature turns off the amplifier's bias circuitry, reducing the supply current. The low 0.4 $\mu\text{A}$  typical shutdown current is achieved by applying a voltage that is as near as GND as possible to the  $\overline{\text{SHUTDOWN}}$  pin. A voltage that is above GND may increase the shutdown current.

There are a few ways to control the micro-power shutdown. These include using a single-pole, single-throw switch, a microprocessor, or a microcontroller. When using a switch, connect an external 100k $\Omega$  pull-down resistor between the  $\overline{\text{SHUTDOWN}}$  pin and GND. Connect the switch between the  $\overline{\text{SHUTDOWN}}$  pin and  $V_{DD}$ . Select normal amplifier operation by closing the switch. Opening the switch connects the  $\overline{\text{SHUTDOWN}}$  pin to GND through the pull-down resistor, activating micro-power shutdown. The switch and resistor guarantee that the  $\overline{\text{SHUTDOWN}}$  pin will not float. This prevents unwanted state changes. In a system with a microprocessor or a microcontroller, use a digital output to apply the control voltage to the  $\overline{\text{SHUTDOWN}}$  pin. Driving the  $\overline{\text{SHUTDOWN}}$  pin with active circuitry eliminates the pull-down resistor.

### EXPOSED-DAP PACKAGE PCB MOUNTING CONSIDERATION

The LM4809's exposed-Dap (die attach paddle) package (LD) provides a low thermal resistance between the die and the PCB to which the part is mounted and soldered. This allows rapid heat transfer from the die to the surrounding PCB copper traces, ground plane, and surrounding air.

The LD package should have its DAP soldered to a copper pad on the PCB. The DAP's PCB copper pad may be connected to a large plane of continuous unbroken copper. This plane forms a thermal mass, heat sink, and radiation area.

However, since the LM4809 is designed for headphone applications, connecting a copper plane to the DAP's PCB copper pad is not required. The LM4809's Power Dissipation vs Output Power Curve in the **Typical Performance Characteristics** shows that the maximum power dissipated is just 45mW per amplifier with a 5V power supply and a 32 $\Omega$  load.

Further detailed and specific information concerning PCB layout, fabrication, and mounting an LD (LLP) package is available from National Semiconductor's Package Engineering Group under application note AN1187.

### POWER DISSIPATION

Power dissipation is a major concern when using any power amplifier and must be thoroughly understood to ensure a successful design. Equation 1 states the maximum power dissipation point for a single-ended amplifier operating at a given supply voltage and driving a specified output load.

$$P_{\text{DMAX}} = (V_{\text{DD}})^2 / (2\pi^2 R_L) \quad (1)$$

Since the LM4809 has two operational amplifiers in one package, the maximum internal power dissipation point is twice that of the number which results from Equation 1. Even with the large internal power dissipation, the LM4809 does

not require heat sinking over a large range of ambient temperature. From Equation 1, assuming a 5V power supply and a 32 $\Omega$  load, the maximum power dissipation point is 40mW per amplifier. Thus the maximum package dissipation point is 80mW. The maximum power dissipation point obtained must not be greater than the power dissipation that results from Equation 2:

$$P_{\text{DMAX}} = (T_{\text{JMAX}} - T_A) / \theta_{\text{JA}} \quad (2)$$

For package MUA08A,  $\theta_{\text{JA}} = 210^\circ\text{C/W}$ .  $T_{\text{JMAX}} = 150^\circ\text{C}$  for the LM4809. Depending on the ambient temperature,  $T_A$ , of the system surroundings, Equation 2 can be used to find the maximum internal power dissipation supported by the IC packaging. If the result of Equation 1 is greater than that of Equation 2, then either the supply voltage must be decreased, the load impedance increased or  $T_A$  reduced. For the typical application of a 5V power supply, with a 32 $\Omega$  load, the maximum ambient temperature possible without violating the maximum junction temperature is approximately 133.2 $^\circ\text{C}$  provided that device operation is around the maximum power dissipation point. Power dissipation is a function of output power and thus, if typical operation is not around the maximum power dissipation point, the ambient temperature may be increased accordingly. Refer to the **Typical Performance Characteristics** curves for power dissipation information for lower output powers.

### POWER SUPPLY BYPASSING

As with any power amplifier, proper supply bypassing is critical for low noise performance and high power supply rejection. Applications that employ a 5V regulator typically use a 10 $\mu\text{F}$  in parallel with a 0.1 $\mu\text{F}$  filter capacitors to stabilize the regulator's output, reduce noise on the supply line, and improve the supply's transient response. However, their presence does not eliminate the need for a local 1.0 $\mu\text{F}$  tantalum bypass capacitance connected between the LM4809's supply pins and ground. Keep the length of leads and traces that connect capacitors between the LM4809's power supply pin and ground as short as possible. Connecting a 4.7 $\mu\text{F}$  capacitor,  $C_B$ , between the BYPASS pin and ground improves the internal bias voltage's stability and improves the amplifier's PSRR. The PSRR improvements increase as the bypass pin capacitor value increases. Too large, however, increases the amplifier's turn-on time. The selection of bypass capacitor values, especially  $C_B$ , depends on desired PSRR requirements, click and pop performance (as explained in the section, **Selecting Proper External Components**), system cost, and size constraints.

### SELECTING PROPER EXTERNAL COMPONENTS

Optimizing the LM4809's performance requires properly selecting external components. Though the LM4809 operates well when using external components with wide tolerances, best performance is achieved by optimizing component values.

The LM4809 is unity-gain stable, giving a designer maximum design flexibility. The gain should be set to no more than a given application requires. This allows the amplifier to achieve minimum THD+N and maximum signal-to-noise ratio. These parameters are compromised as the closed-loop gain increases. However, low gain demands input signals with greater voltage swings to achieve maximum output power. Fortunately, many signal sources such as audio

## Application Information (Continued)

CODECs have outputs of  $1V_{RMS}$  ( $2.83V_{P-P}$ ). Please refer to the **Audio Power Amplifier Design** section for more information on selecting the proper gain.

### Input and Output Capacitor Value Selection

Amplifying the lowest audio frequencies requires high value input and output coupling capacitors ( $C_i$  and  $C_o$  in *Figure 1*). A high value capacitor can be expensive and may compromise space efficiency in portable designs. In many cases, however, the speakers used in portable systems, whether internal or external, have little ability to reproduce signals below 150Hz. Applications using speakers with this limited frequency response reap little improvement by using high value input and output capacitors.

Besides affecting system cost and size,  $C_i$  has an effect on the LM4809's click and pop performance. The magnitude of the pop is directly proportional to the input capacitor's size. Thus, pops can be minimized by selecting an input capacitor value that is no higher than necessary to meet the desired  $-3dB$  frequency. Please refer to the **Optimizing Click and Pop Reduction Performance** section for a more detailed discussion on click and pop performance.

As shown in *Figure 1*, the input resistor,  $R_i$  and the input capacitor,  $C_i$ , produce a  $-3dB$  high pass filter cutoff frequency that is found using Equation (3). In addition, the output load  $R_L$ , and the output capacitor  $C_o$ , produce a  $-3dB$  high pass filter cutoff frequency defined by Equation (4).

$$f_{i-3db} = 1/2\pi R_i C_i \quad (3)$$

$$f_{o-3db} = 1/2\pi R_L C_o \quad (4)$$

Also, careful consideration must be taken in selecting a certain type of capacitor to be used in the system. Different types of capacitors (tantalum, electrolytic, ceramic) have unique performance characteristics and may affect overall system performance.

### Bypass Capacitor Value Selection

Besides minimizing the input capacitor size, careful consideration should be paid to the value of  $C_B$ , the capacitor connected to the BYPASS pin. Since  $C_B$  determines how fast the LM4809 settles to quiescent operation, its value is critical when minimizing turn-on pops. The slower the LM4809's outputs ramp to their quiescent DC voltage (nominally  $1/2 V_{DD}$ ), the smaller the turn-on pop. Choosing  $C_B$  equal to  $4.7\mu F$  along with a small value of  $C_i$  (in the range of  $0.1\mu F$  to  $0.47\mu F$ ), produces a click-less and pop-less shutdown function. As discussed above, choosing  $C_i$  no larger than necessary for the desired bandwidth helps minimize clicks and pops.

### OPTIMIZING CLICK AND POP REDUCTION PERFORMANCE

The LM4809 contains circuitry that minimizes turn-on and shutdown transients or "clicks and pop". For this discussion, turn-on refers to either applying the power supply voltage or when the shutdown mode is deactivated. During turn-on, the LM4809's internal amplifiers are configured as unity gain buffers. An internal current source charges up the capacitor on the BYPASS pin in a controlled, linear manner. The gain of the internal amplifiers remains unity until the voltage on the BYPASS pin reaches  $1/2 V_{DD}$ . As soon as the voltage on

the BYPASS pin is stable, the device becomes fully operational. During device turn-on, a transient (pop) is created from a voltage difference between the input and output of the amplifier as the voltage on the BYPASS pin reaches  $1/2 V_{DD}$ . For this discussion, the input of the amplifier refers to the node between  $R_i$  and  $C_i$ . Ideally, the input and output track the voltage applied to the BYPASS pin. During turn-on, the buffer-configured amplifier output charges the input capacitor,  $C_i$ , through the input resistor,  $R_i$ . This input resistor delays the charging time of  $C_i$  thereby causing the voltage difference between the input and output that results in a transient (pop). Higher value capacitors need more time to reach a quiescent DC voltage (usually  $1/2 V_{DD}$ ) when charged with a fixed current. Decreasing the value of  $C_i$  and  $R_i$  will minimize turn-on pops at the expense of the desired  $-3dB$  frequency.

Although the BYPASS pin current cannot be modified, changing the size of  $C_B$  alters the device's turn-on time and the magnitude of "clicks and pops". Increasing the value of  $C_B$  reduces the magnitude of turn-on pops. However, this presents a tradeoff: as the size of  $C_B$  increases, the turn-on time increases. There is a linear relationship between the size of  $C_B$  and the turn-on time. Here are some typical turn-on times for various values of  $C_B$ :

$C_B$	$T_{ON}$
$0.1\mu F$	80ms
$0.22\mu F$	170ms
$0.33\mu F$	270ms
$0.47\mu F$	370ms
$0.68\mu F$	490ms
$1.0\mu F$	920ms
$2.2\mu F$	1.8sec
$3.3\mu F$	2.8sec
$4.7\mu F$	3.4sec
$10\mu F$	7.7sec

In order eliminate "clicks and pops", all capacitors must be discharged before turn-on. Rapidly switching  $V_{DD}$  may not allow the capacitors to fully discharge, which may cause "clicks and pops". In a single-ended configuration, the output is coupled to the load by  $C_o$ . This capacitor usually has a high value.  $C_o$  discharges through internal  $20k\Omega$  resistors. Depending on the size of  $C_o$ , the discharge time constant can be relatively large. To reduce transients in single-ended mode, an external  $1k\Omega$ – $5k\Omega$  resistor can be placed in parallel with the internal  $20k\Omega$  resistor. The tradeoff for using this resistor is increased quiescent current.

## AUDIO POWER AMPLIFIER DESIGN

### Design a Dual 70mW/32 $\Omega$ Audio Amplifier

Given:

Power Output	70 mW
Load Impedance	32 $\Omega$
Input Level	1 Vrms (max)
Input Impedance	20k $\Omega$
Bandwidth	100 Hz–20 kHz $\pm$ 0.50dB

The design begins by specifying the minimum supply voltage necessary to obtain the specified output power. One way to

## Application Information (Continued)

find the minimum supply voltage is to use the Output Power vs Supply Voltage curve in the **Typical Performance Characteristics** section. Another way, using Equation (5), is to calculate the peak output voltage necessary to achieve the desired output power for a given load impedance. To account for the amplifier's dropout voltage, two additional voltages, based on the Dropout Voltage vs Supply Voltage in the **Typical Performance Characteristics** curves, must be added to the result obtained by Equation (5). For a single-ended application, the result is Equation (6).

$$V_{\text{opeak}} = \sqrt{(2R_L P_O)} \quad (5)$$

$$V_{\text{DD}} \geq (2V_{\text{OPEAK}} + (V_{\text{ODTOP}} + V_{\text{ODBOT}})) \quad (6)$$

The Output Power vs Supply Voltage graph for a 32Ω load indicates a minimum supply voltage of 4.8V. This is easily met by the commonly used 5V supply voltage. The additional voltage creates the benefit of headroom, allowing the LM4809 to produce peak output power in excess of 70mW without clipping or other audible distortion. The choice of supply voltage must also not create a situation that violates maximum power dissipation as explained above in the **Power Dissipation** section. Remember that the maximum power dissipation point from Equation (1) must be multiplied by two since there are two independent amplifiers inside the package. Once the power dissipation equations have been addressed, the required gain can be determined from Equation (7).

$$A_V \geq \sqrt{(P_O R_L)} / (V_{\text{IN}}) = V_{\text{orms}} / V_{\text{inrms}} \quad (7)$$

Thus, a minimum gain of 1.497 allows the LM4809 to reach full output swing and maintain low noise and THD+N performance. For this example, let  $A_V = 1.5$ .

The amplifiers overall gain is set using the input ( $R_i$ ) and feedback ( $R_f$ ) resistors. With the desired input impedance set at 20kΩ, the feedback resistor is found using Equation (8).

$$A_V = R_f / R_i \quad (8)$$

The value of  $R_f$  is 30kΩ.

The last step in this design is setting the amplifier's -3dB frequency bandwidth. To achieve the desired ±0.25dB pass band magnitude variation limit, the low frequency response must extend to at least one-fifth the lower bandwidth limit and the high frequency response must extend to at least five times the upper bandwidth limit. The gain variation for both response limits is 0.17dB, well within the ±0.25dB desired limit. The results are an

$$f_L = 100\text{Hz} / 5 = 20\text{Hz} \quad (9)$$

and a

$$f_H = 20\text{kHz} * 5 = 100\text{kHz} \quad (10)$$

As stated in the **External Components** section, both  $R_i$  in conjunction with  $C_i$ , and  $C_o$  with  $R_L$ , create first order high-pass filters. Thus to obtain the desired low frequency response of 100Hz within ±0.5dB, both poles must be taken into consideration. The combination of two single order filters at the same frequency forms a second order response. This results in a signal which is down 0.34dB at five times away from the single order filter -3dB point. Thus, a frequency of 20Hz is used in the following equations to ensure that the response is better than 0.5dB down at 100Hz.

$$C_i \geq 1 / (2\pi * 20\text{k}\Omega * 20\text{Hz}) = 0.397\mu\text{F}; \text{ use } 0.39\mu\text{F}. \quad (11)$$

$$C_o \geq 1 / (2\pi * 32\Omega * 20\text{Hz}) = 249\mu\text{F}; \text{ use } 330\mu\text{F}. \quad (12)$$

The high frequency pole is determined by the product of the desired high frequency pole,  $f_H$ , and the closed-loop gain,  $A_V$ . With a closed-loop gain of 1.5 and  $f_H = 100\text{kHz}$ , the resulting GBWP = 150kHz which is much smaller than the LM4809's GBWP of 900kHz. This figure displays that if a designer has a need to design an amplifier with a higher gain, the LM4809 can still be used without running into bandwidth limitations.

# Demonstration Board Schematic

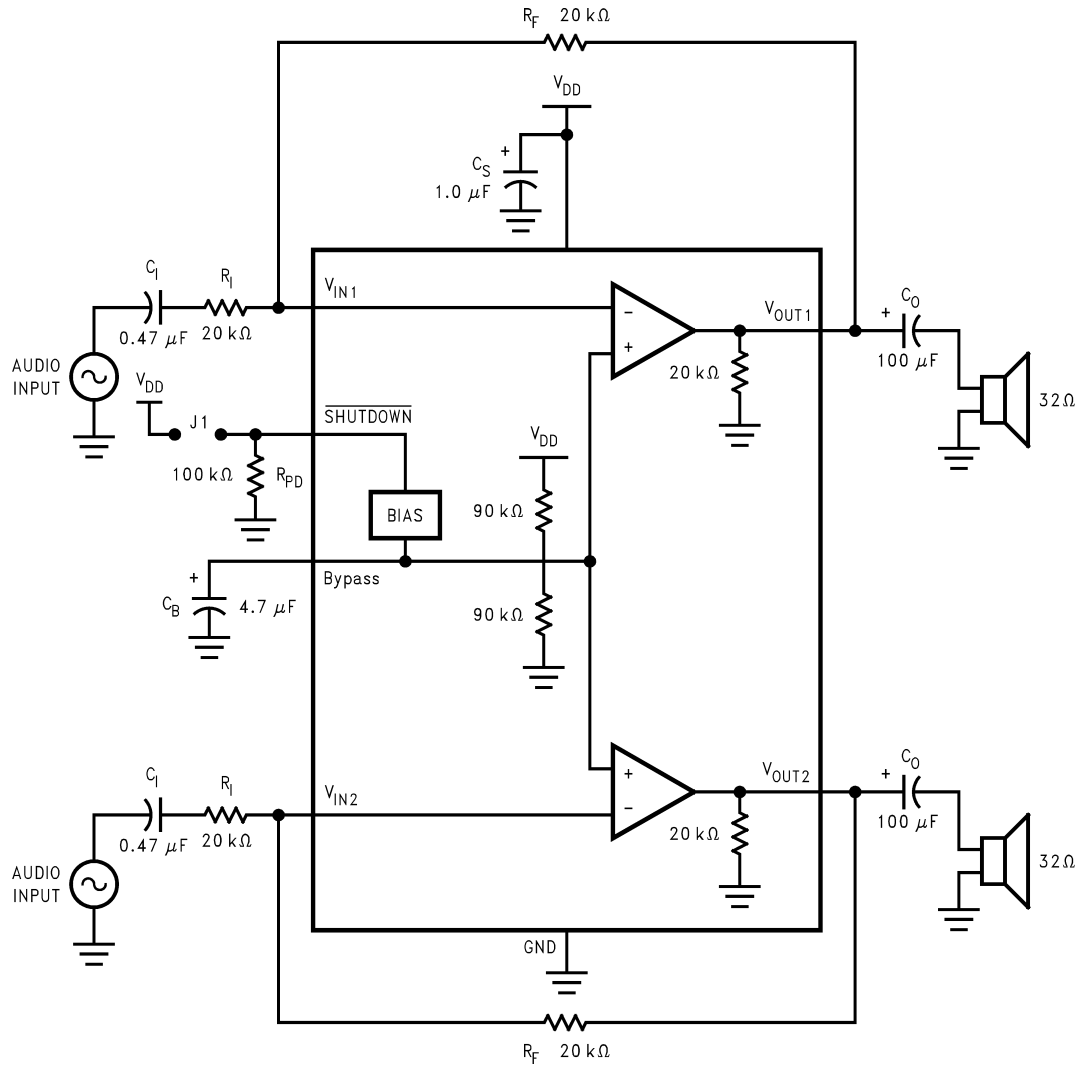

20009057

FIGURE 2. LM4809 Demonstration Board Schematic

## Demonstration Board Layout

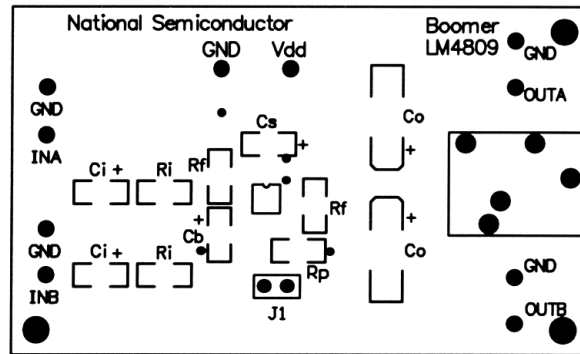

20009058

FIGURE 3. Recommended MSOP PC Board Layout  
Component-Side Silkscreen

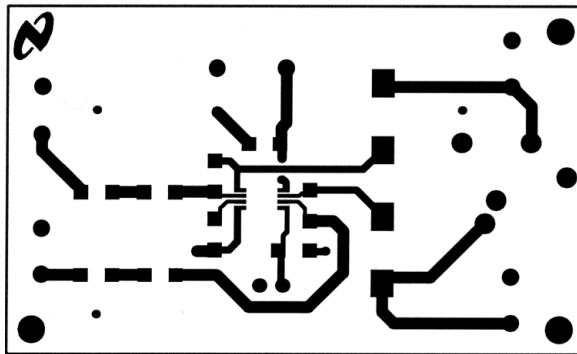

20009059

FIGURE 4. Recommended MSOP PC Board Layout  
Component-Side Layout

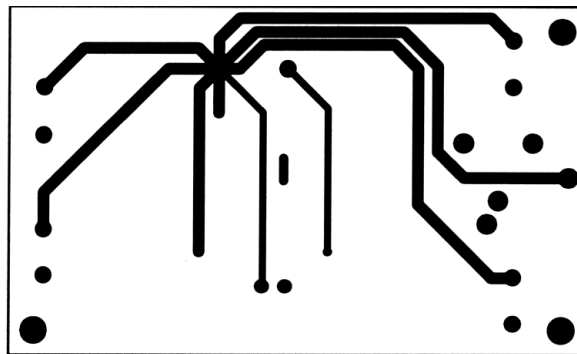

20009060

FIGURE 5. Recommended MSOP PC Board Layout  
Bottom-Side Layout

# Demonstration Board Layout (Continued)

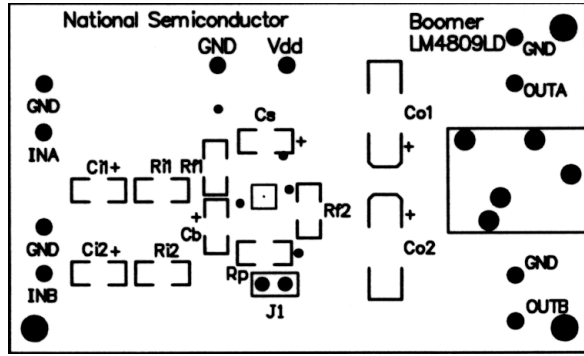

20009062

FIGURE 6. Recommended LD PC Board Layout Component-Side Silkscreen

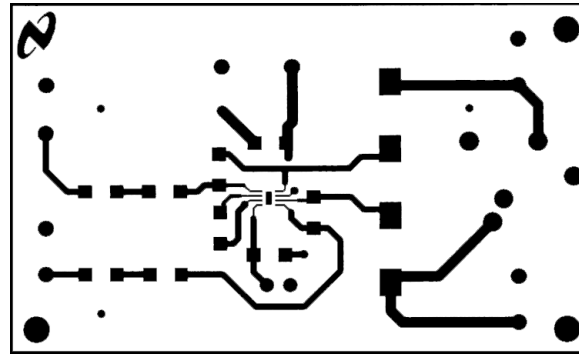

20009063

FIGURE 7. Recommended LD PC Board Layout Component-Side Layout

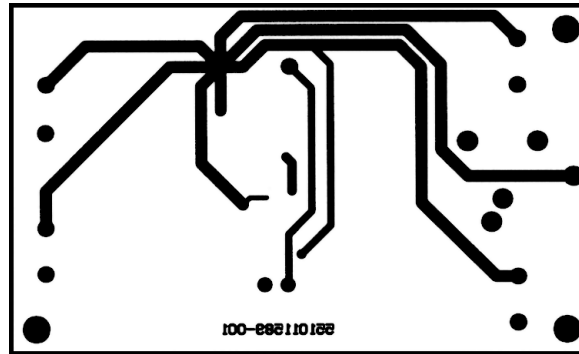

20009064

FIGURE 8. Recommended LD PC Board Layout Bottom-Side Layout



**Physical Dimensions** inches (millimeters) unless otherwise noted

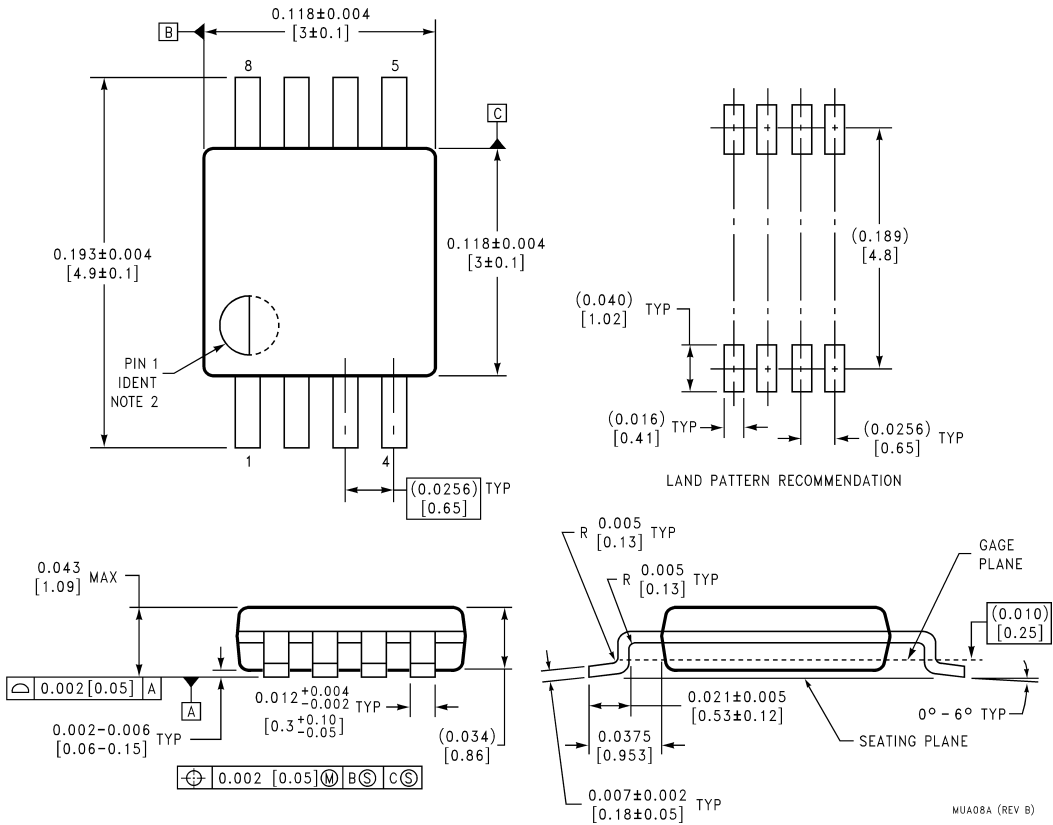

**Order Number LM4809MM**  
**NS Package Number MUA08A**

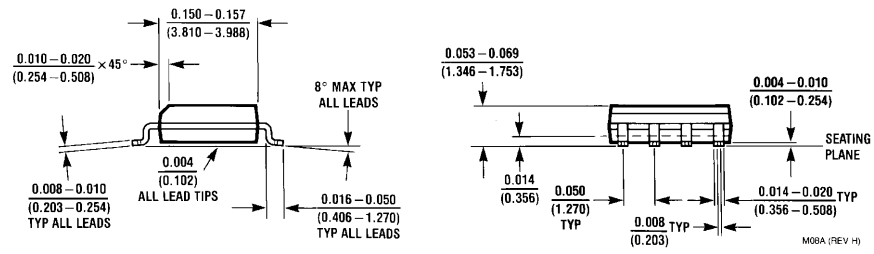
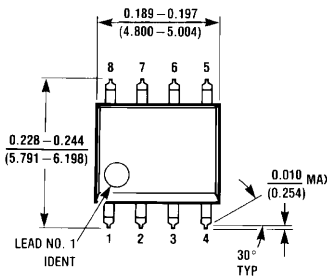

**Order Number LM4809MA**  
**NS Package Number M08A**

**Physical Dimensions** inches (millimeters) unless otherwise noted (Continued)

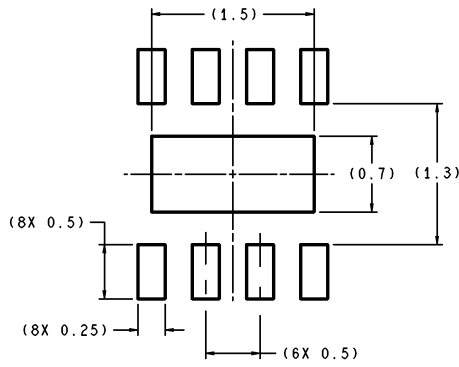

DIMENSIONS ARE IN MILLIMETERS

RECOMMENDED LAND PATTERN  
1:1 RATIO WITH PKG SOLDER PADS

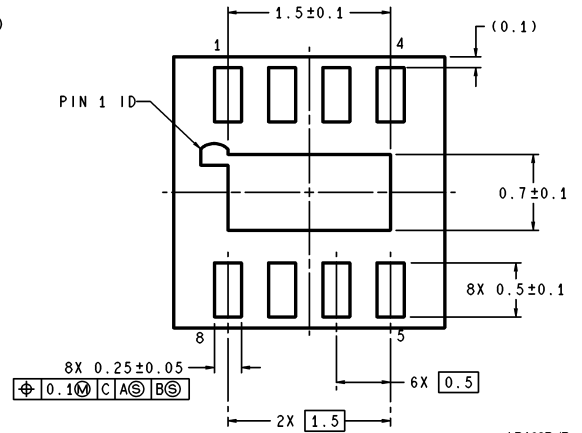
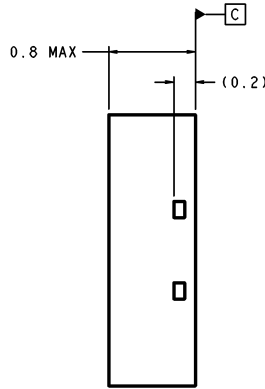
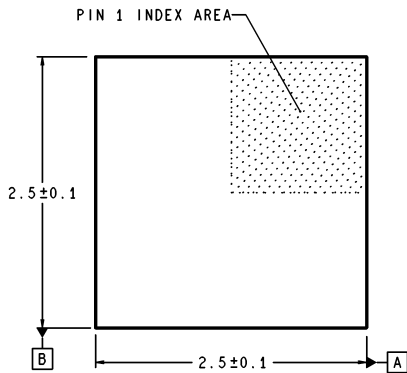

LDA08B (Rev A)

Order Number LM4809LD  
NS Package Number LDA08B

**LIFE SUPPORT POLICY**

NATIONAL'S PRODUCTS ARE NOT AUTHORIZED FOR USE AS CRITICAL COMPONENTS IN LIFE SUPPORT DEVICES OR SYSTEMS WITHOUT THE EXPRESS WRITTEN APPROVAL OF THE PRESIDENT AND GENERAL COUNSEL OF NATIONAL SEMICONDUCTOR CORPORATION. As used herein:

1. Life support devices or systems are devices or systems which, (a) are intended for surgical implant into the body, or (b) support or sustain life, and whose failure to perform when properly used in accordance with instructions for use provided in the labeling, can be reasonably expected to result in a significant injury to the user.
2. A critical component is any component of a life support device or system whose failure to perform can be reasonably expected to cause the failure of the life support device or system, or to affect its safety or effectiveness.



**National Semiconductor Corporation**  
Americas  
Email: support@nsc.com

www.national.com

**National Semiconductor Europe**  
Fax: +49 (0) 180-530 85 86  
Email: europe.support@nsc.com  
Deutsch Tel: +49 (0) 69 9508 6208  
English Tel: +44 (0) 870 24 0 2171  
Français Tel: +33 (0) 1 41 91 8790

**National Semiconductor Asia Pacific Customer Response Group**  
Tel: 65-2544466  
Fax: 65-2504466  
Email: ap.support@nsc.com

**National Semiconductor Japan Ltd.**  
Tel: 81-3-5639-7560  
Fax: 81-3-5639-7507

National does not assume any responsibility for use of any circuitry described, no circuit patent licenses are implied and National reserves the right at any time without notice to change said circuitry and specifications.