

KA248/KA348

Quad Operational Amplifier

Features

- KA741 OP Amp operating characteristics
- Low supply current drain
- Class AB output stage no crossover distortion
- Pin compatible with the KA324 & KA3403
- Low input offset voltage : 1mV Typ.
- Low input offset current : 4nA Typ.
- Low input bias current : 30nA Typ.
- Gain bandwidth (unity gain): 1.0MHz Typ.
- High degree of isolation between amplifiers: 120dB
- Overload protection for inputs and outputs

Description

The KA248/KA348 is a true quad KA741. It consists of four independent, high gain, internally compensated, low power operational amplifiers which have been designed to provide functional characteristics identical to those of the familiar KA741 operational amplifier. In addition the total supply current for all four amplifiers is comparable to the supply current of a single KA741 type OP Amp. Other features include input offset currents and input bias current which are much less than those of a standard KA741. Also, excellent isolation between amplifiers has been achieved by independently biasing each amplifier and using layout techniques which minimize thermal coupling.

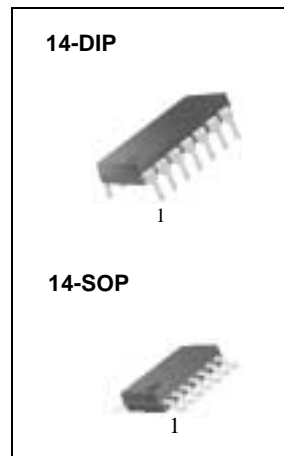

Internal Block Diagram

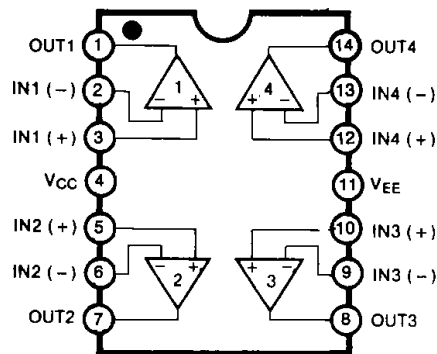

Schematic Diagram

(One Section Only)

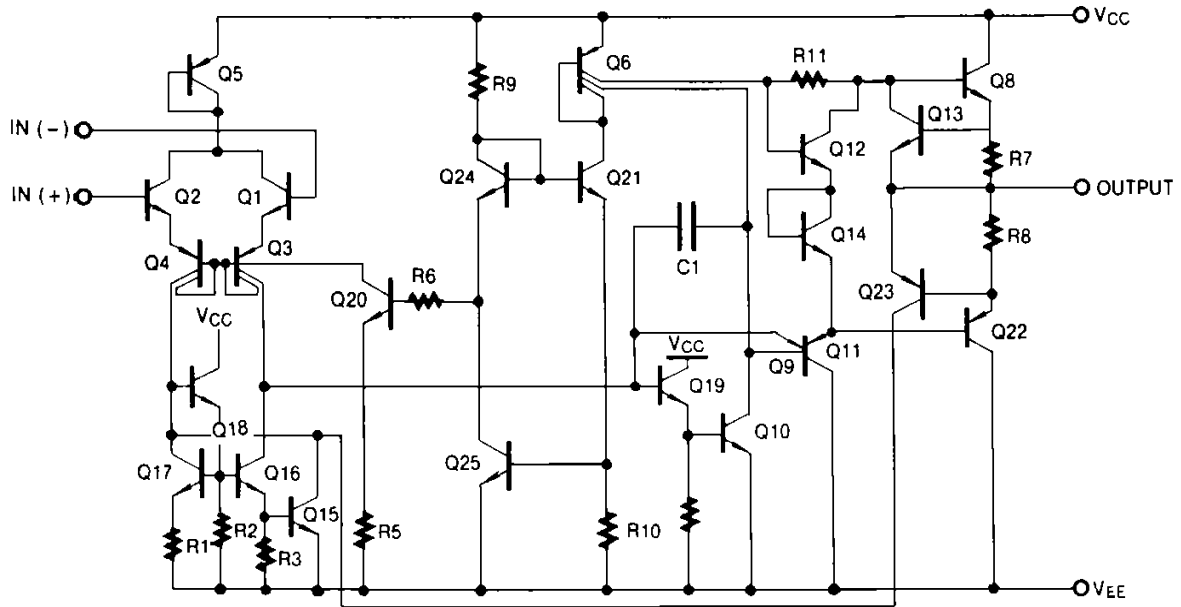

Absolute Maximum Ratings

Parameter	Symbol	Value	Unit
Supply Voltage	V_{CC}	± 18	V
Differential Input Voltage	$V_{I(DIFF)}$	36	V
Input Voltage	V_I	± 18	V
Output Short Circuit Duration	-	Continuous	-
Operating Temperature			
KA248	TOPR	- 25 ~ +85	$^{\circ}\text{C}$
KA348		0 ~ +70	$^{\circ}\text{C}$
Storage Temperature	TSTG	- 65 ~ +150	$^{\circ}\text{C}$

Electrical Characteristics

(VCC =15V, VEE= -15V, TA=25 °C, unless otherwise specified)

Parameter	Symbol	Conditions	KA248			KA348			Unit	
			Min.	Typ.	Max.	Min.	Typ.	Max.		
Input Offset Voltage	V _{IO}	R _S ≤10KΩ	-	1	6.0	-	1	6.0	mV	
		NOTE 1	-	-	7.5	-	-	7.5		
Input Offset Current	I _{IO}		-	4	50	-	4	50	nA	
		NOTE 1	-	-	125	-	-	100		
Input Bias Current	I _{BIAS}		-	30	200	-	30	200	nA	
		NOTE 1	-	-	500	-	-	400		
Input Resistance	R _I	-	0.8	2.5	-	0.8	2.5	-	MΩ	
Supply Current (all Amplifiers)	I _{CC}	-	-	2.4	4.5	-	2.4	4.5	mA	
Large Signal Voltage Gain	G _V	R _L ≥2KΩ	25	160	-	25	160	-	V/mV	
		NOTE 1	15	-	-	15	-	-		
Channel Separation	CS	f = 1KHz to 20KHz	-	120	-	-	120	-	dB	
Common Mode Input Voltage Range	V _{I(R)}	NOTE 1	±12	-	-	±12	-	-	V	
Small Signal Bandwidth	BW	G _V = 1	-	1.0	-	-	1.0	-	MHz	
Phase Margin (Note2)	MPH	G _V = 1	-	60	-	-	60	-	Degree	
Slew Rate (Note2)	SR	G _V = 1	-	0.5	-	-	0.5	-	V/μs	
Output Short Circuit Current	I _{SC}	-	-	25	-	-	25	-	mA	
Output Voltage Swing	V _{O(P-P)}	R _L ≥10KΩ	NOTE 1	±12	±13	-	±12	±13	-	V
		R _L ≥2KΩ		±10	±12	-	±10	±12	-	
Common Mode Rejection Ratio	CMRR	R _S ≥10KΩ	NOTE 1	70	90	-	70	90	-	dB
Power Supply Rejection Ratio	PSRR	R _S ≥10KΩ	NOTE 1	77	96	-	77	96	-	dB

Note :

- KA348: 0 ≤ T_A ≤ +70 °C , KA248: -25 ≤ T_A ≤ +85 °C
- Guaranteed by design.

Typical Performance Characteristics

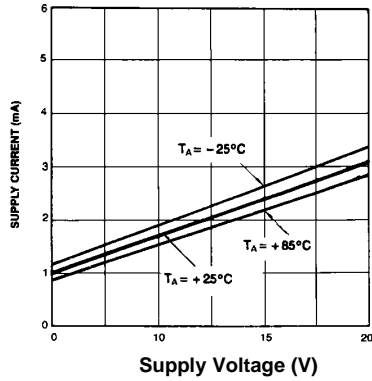

Figure 1. Supply Current vs Supply voltage

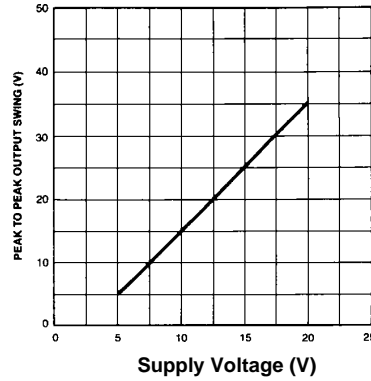

Figure 2. Output Voltage Swing vs Supply voltage

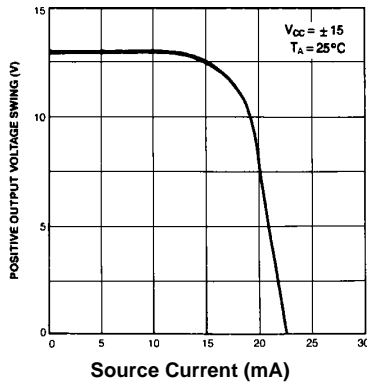

Figure 3. Output voltage swing vs Source Current (mA)

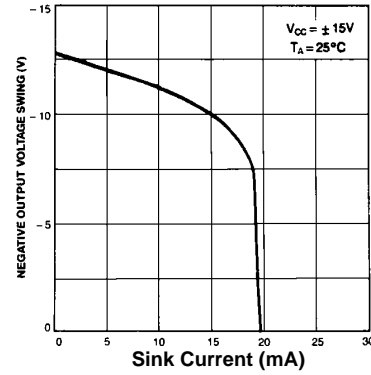

Figure 4. Output voltage swing vs Sink Current (mA)

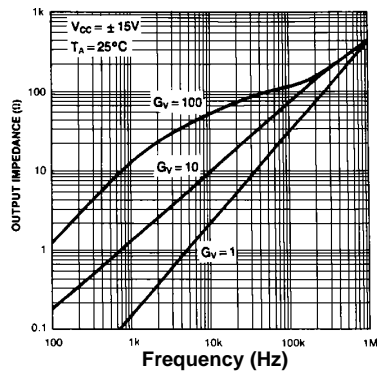

Figure 5. Output Impedance vs Frequency

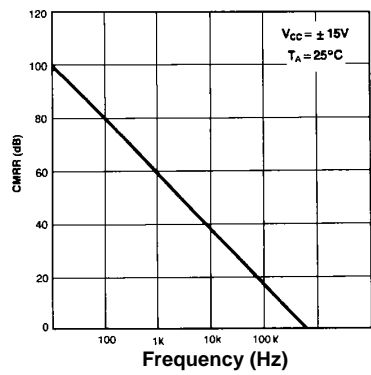

Figure 6. Common-mode Rejection Ratio vs Frequency

Typical Performance Characteristics (continued)

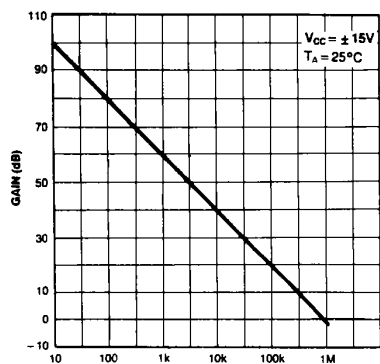

Figure 7. Open Loop Frequency Response

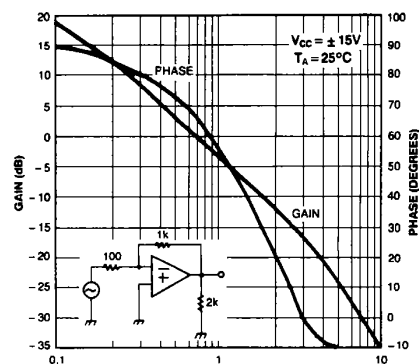

Figure 8. Bode Plot

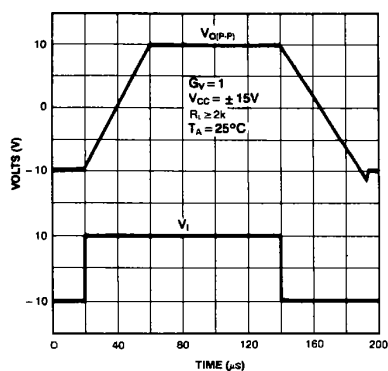

Figure 9. Large Signal Pulse Response

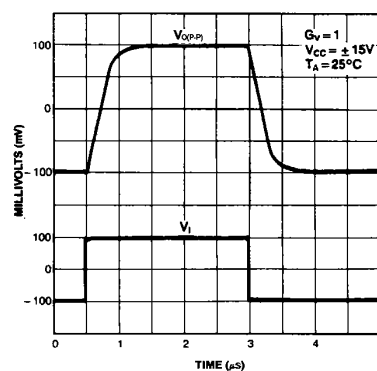

Figure 10. Small Signal Pulse Response

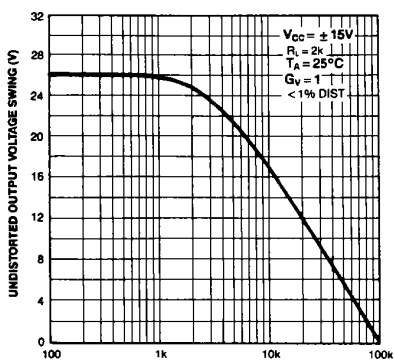

Figure 11. Undistorted Output Voltage Swing vs Frequency

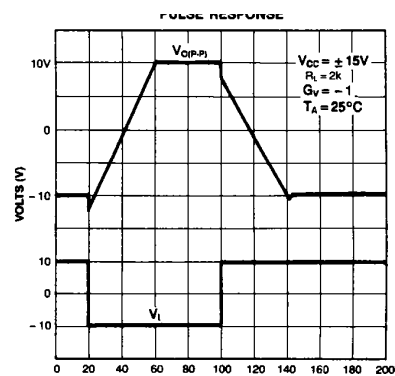

Figure 12. Inverting Large Signal Pulse Response

Typical Performance Characteristics (continued)

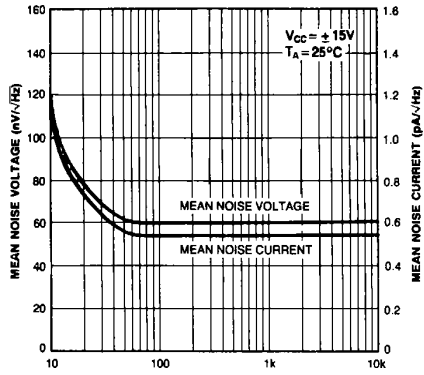

Figure 13. Input Noise Voltage And Noise Current vs Frequency

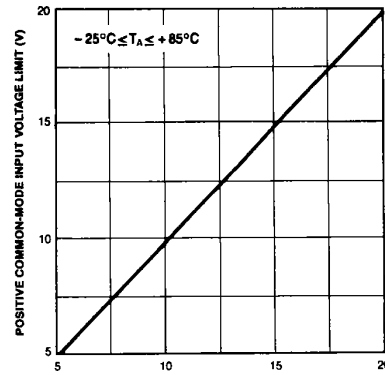

Figure 14. Positive Common Mode Input Voltage Limit vs Positive Supply Voltage

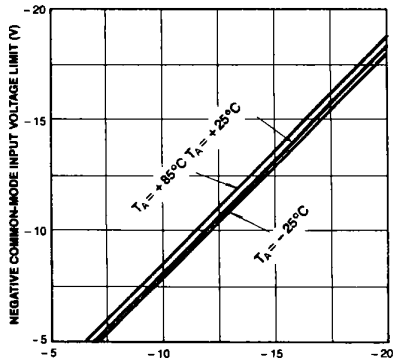
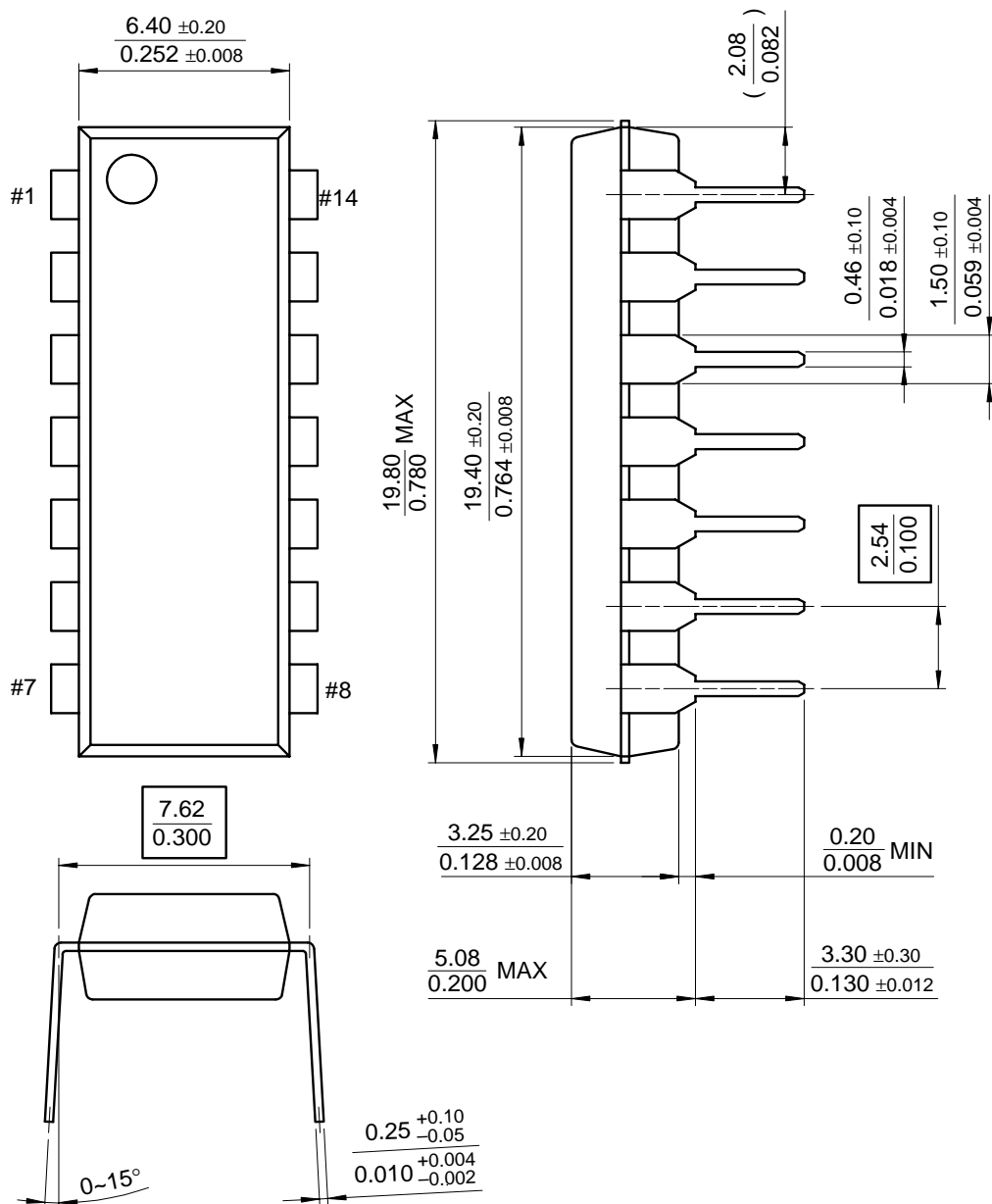

Figure 15. Negative Common-mode Input Voltage Limit vs Negative Supply Voltage

Mechanical Dimensions

Package

14-DIP



Mechanical Dimensions (Continued)

Package

14-SOP

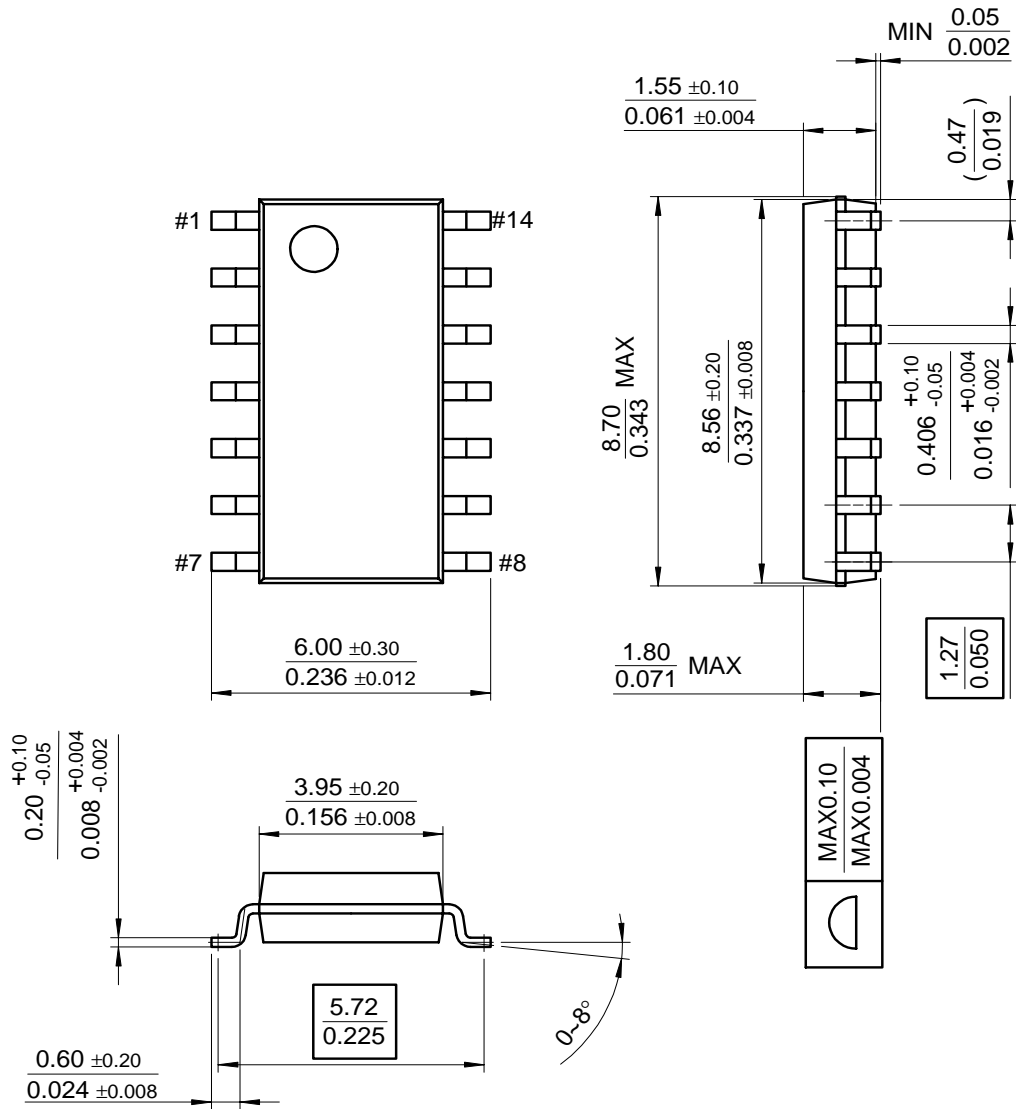

Ordering Information

Product Number	Package	Operating Temperature
KA348	14 DIP	0 ~ + 70°C
KA348D	14 SOP	
KA248	14 DIP	-25 ~ +85 °C
KA248D	14 SOP	

DISCLAIMER

FAIRCHILD SEMICONDUCTOR RESERVES THE RIGHT TO MAKE CHANGES WITHOUT FURTHER NOTICE TO ANY PRODUCTS HEREIN TO IMPROVE RELIABILITY, FUNCTION OR DESIGN. FAIRCHILD DOES NOT ASSUME ANY LIABILITY ARISING OUT OF THE APPLICATION OR USE OF ANY PRODUCT OR CIRCUIT DESCRIBED HEREIN; NEITHER DOES IT CONVEY ANY LICENSE UNDER ITS PATENT RIGHTS, NOR THE RIGHTS OF OTHERS.

LIFE SUPPORT POLICY

FAIRCHILD'S PRODUCTS ARE NOT AUTHORIZED FOR USE AS CRITICAL COMPONENTS IN LIFE SUPPORT DEVICES OR SYSTEMS WITHOUT THE EXPRESS WRITTEN APPROVAL OF THE PRESIDENT OF FAIRCHILD SEMICONDUCTOR CORPORATION. As used herein:

1. Life support devices or systems are devices or systems which, (a) are intended for surgical implant into the body, or (b) support or sustain life, and (c) whose failure to perform when properly used in accordance with instructions for use provided in the labeling, can be reasonably expected to result in a significant injury of the user.
2. A critical component in any component of a life support device or system whose failure to perform can be reasonably expected to cause the failure of the life support device or system, or to affect its safety or effectiveness.