

74AC540

Octal Buffer/Line Driver with 3-STATE Outputs

General Description

The AC540 is an octal buffer/line drivers designed to be employed as memory and address drivers, clock drivers and bus oriented transmitter/receivers.

These devices are similar in function to the AC240 while providing flow-through architecture (inputs on opposite side from outputs). This pinout arrangement makes these devices especially useful as output ports for microprocessors, allowing ease of layout and greater PC board density.

Features

- I_{CC} and I_{OZ} reduced by 50%
- 3-STATE inverting outputs
- Inputs and outputs opposite side of package, allowing easier interface to microprocessors
- Output source/sink 24 mA

Ordering Code:

| Order Number | Package Number | Package Description |
|--------------|----------------|---|
| 74AC540SC | M20B | 20-Lead Small Outline Integrated Circuit (SOIC), JEDEC MS-013, 0.300" Wide |
| 74AC540SJ | M20D | Pb-Free 20-Lead Small Outline Package (SOP), EIAJ TYPE II, 5.3mm Wide |
| 74AC540MTC | MTC20 | 20-Lead Thin Shrink Small Outline Package (TSSOP), JEDEC MO-153, 4.4mm Wide |
| 74AC540PC | N20A | 20-Lead Plastic Dual-In-Line Package (PDIP), JEDEC MS-001, 0.300" Wide |

Device also available in Tape and Reel. Specify by appending suffix letter "X" to the ordering code.
Pb-Free package per JEDEC J-STD-020B.

Logic Symbol

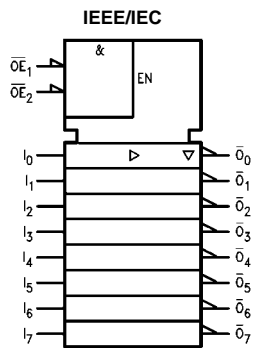

Connection Diagram

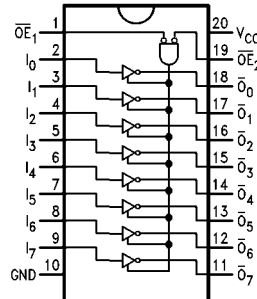

Truth Table

| Inputs | | | Outputs |
|-------------------|-------------------|---|---------|
| \overline{OE}_1 | \overline{OE}_2 | I | |
| L | L | H | L |
| H | X | X | Z |
| X | H | X | Z |
| L | L | L | H |

H = HIGH Voltage Level
L = LOW Voltage Level
X = Immaterial
Z = High Impedance

FACT™ is a trademark of Fairchild Semiconductor Corporation.

74AC540 Octal Buffer/Line Driver with 3-STATE Outputs

Absolute Maximum Ratings(Note 1)

| | |
|--|--------------------------|
| Supply Voltage (V_{CC}) | -0.5V to +7.0V |
| DC Input Diode Current (I_{IK}) | |
| $V_I = -0.5V$ | -20 mA |
| $V_I = V_{CC} + 0.5V$ | +20 mA |
| DC Input Voltage (V_I) | -0.5V to $V_{CC} + 0.5V$ |
| DC Output Diode Current (I_{OK}) | |
| $V_O = -0.5V$ | -20 mA |
| $V_O = V_{CC} + 0.5V$ | +20 mA |
| DC Output Voltage (V_O) | -0.5V to $V_{CC} + 0.5V$ |
| DC Output Source or Sink Current (I_O) | ±50 mA |
| DC V_{CC} or Ground Current per Output Pin (I_{CC} or I_{GND}) | ±50 mA |
| Storage Temperature (T_{STG}) | -65°C to +150°C |
| Junction Temperature (T_J) | |
| PDIP | 140°C |

Recommended Operating Conditions

| | |
|---|----------------|
| Supply Voltage (V_{CC}) | 2.0V to 6.0V |
| Input Voltage (V_I) | 0V to V_{CC} |
| Output Voltage (V_O) | 0V to V_{CC} |
| Operating Temperature (T_A) | -40°C to +85°C |
| Minimum Input Edge Rate ($\Delta V/\Delta t$) | 125 mV/ns |
| V_{IN} from 30% to 70% of V_{CC} | |
| V_{CC} @ 3.3V, 4.5V, 5.5V | |

Note 1: Absolute maximum ratings are those values beyond which damage to the device may occur. The databook specifications should be met, without exception, to ensure that the system design is reliable over its power supply, temperature, and output/input loading variables. Fairchild does not recommend operation of FACT™ circuits outside databook specifications.

DC Electrical Characteristics

| Symbol | Parameter | V_{CC} (V) | $T_A = +25^\circ\text{C}$ | | $T_A = -40^\circ\text{C to } +85^\circ\text{C}$ | | Units | Conditions |
|----------------------|-----------------------------------|-----------------|---------------------------|-------------------|---|--|-------|---|
| | | | Typ | Guaranteed Limits | | | | |
| V_{IH} | Minimum HIGH Level Input Voltage | 3.0 | 1.5 | 2.1 | 2.1 | | V | $V_{OUT} = 0.1V$ or $V_{CC} - 0.1V$ |
| | | 4.5 | 2.25 | 3.15 | 3.15 | | | |
| | | 5.5 | 2.75 | 3.85 | 3.85 | | | |
| V_{IL} | Maximum LOW Level Input Voltage | 3.0 | 1.5 | 0.9 | 0.9 | | V | $V_{OUT} = 0.1V$ or $V_{CC} - 0.1V$ |
| | | 4.5 | 2.25 | 1.35 | 1.35 | | | |
| | | 5.5 | 2.75 | 1.65 | 1.65 | | | |
| V_{OH} | Minimum HIGH Level Output Voltage | 3.0 | 2.99 | 2.9 | 2.9 | | V | $I_{OUT} = -50 \mu\text{A}$ |
| | | 4.5 | 4.49 | 4.4 | 4.4 | | | |
| | | 5.5 | 5.49 | 5.4 | 5.4 | | | |
| | | 3.0 | | 2.56 | 2.46 | | V | $V_{IN} = V_{IL}$ or V_{IH} $I_{OH} = -12 \text{ mA}$ $I_{OH} = -24 \text{ mA}$ $I_{OH} = -24 \text{ mA (Note 2)}$ |
| | | 4.5 | | 3.86 | 3.76 | | | |
| 5.5 | | 4.86 | 4.76 | | | | | |
| V_{OL} | Maximum LOW Level Output Voltage | 3.0 | 0.002 | 0.1 | 0.1 | | V | $I_{OUT} = 50 \mu\text{A}$ |
| | | 4.5 | 0.001 | 0.1 | 0.1 | | | |
| | | 5.5 | 0.001 | 0.1 | 0.1 | | | |
| | | 3.0 | | 0.36 | 0.44 | | V | $V_{IN} = V_{IL}$ or V_{IH} $I_{OL} = 12 \text{ mA}$ $I_{OL} = 24 \text{ mA}$ $I_{OL} = 24 \text{ mA (Note 2)}$ |
| | | 4.5 | | 0.36 | 0.44 | | | |
| 5.5 | | 0.36 | 0.44 | | | | | |
| I_{IN} (Note 4) | Maximum Input Leakage Current | 5.5 | | ±0.1 | ±1.0 | | μA | $V_I = V_{CC}, \text{GND}$ |
| I_{OZ} | Maximum 3-STATE Current | 5.5 | | ±0.25 | ±2.5 | | μA | V_I (OE) = V_{IL}, V_{IH} $V_I = V_{CC}, \text{GND}$ $V_O = V_{CC}, \text{GND}$ |
| I_{OLD} | Minimum Dynamic | 5.5 | | | 75 | | mA | $V_{OLD} = 1.65V \text{ Max}$ |
| I_{OHD} | Output Current (Note 3) | 5.5 | | | -75 | | mA | $V_{OHD} = 3.85V \text{ Min}$ |
| I_{CC} (Note 4) | Maximum Quiescent Supply Current | 5.5 | | 4.0 | 40.0 | | μA | $V_{IN} = V_{CC}$ or GND |

Note 2: All outputs loaded; thresholds on input associated with output under test.

Note 3: Maximum test duration 2.0 ms, one output loaded at a time.

Note 4: I_{IN} and I_{CC} @ 3.0V are guaranteed to be less than or equal to the respective limit @ 5.5V V_{CC} .

AC Electrical Characteristics

| Symbol | Parameter | V _{CC} (V) (Note 5) | T _A = +25°C C _L = 50 pF | | | T _A = -40°C to +85°C C _L = 50 pF | | Units |
|------------------|---------------------|------------------------------------|--|-----|------|---|------|-------|
| | | | Min | Typ | Max | Min | Max | |
| t _{PLH} | Propagation Delay | 3.3 | 1.5 | 5.5 | 7.5 | 1.0 | 8.0 | ns |
| | Data to Output | 5.0 | 1.5 | 4.0 | 6.0 | 1.0 | 6.5 | |
| t _{PHL} | Propagation Delay | 3.3 | 1.5 | 5.0 | 7.0 | 1.0 | 7.5 | ns |
| | Data to Output | 5.0 | 1.5 | 4.0 | 5.5 | 1.0 | 6.0 | |
| t _{PZH} | Output Enable Time | 3.3 | 3.0 | 8.5 | 11.0 | 2.5 | 12.0 | ns |
| | | 5.0 | 2.0 | 6.5 | 8.5 | 2.0 | 9.5 | |
| t _{PZL} | Output Enable Time | 3.3 | 2.5 | 7.5 | 10.0 | 2.0 | 11.0 | ns |
| | | 5.0 | 2.0 | 6.0 | 7.5 | 1.5 | 8.5 | |
| t _{PHZ} | Output Disable Time | 3.3 | 2.5 | 8.5 | 13.0 | 1.5 | 14.0 | ns |
| | | 5.0 | 1.5 | 7.5 | 10.5 | 1.0 | 11.0 | |
| t _{PLZ} | Output Disable Time | 3.3 | 2.5 | 7.0 | 10.0 | 2.0 | 11.0 | ns |
| | | 5.0 | 1.5 | 6.0 | 8.0 | 1.5 | 9.0 | |

Note 5: Voltage Range 3.3 is 3.3V ± 0.3V
Voltage Range 5.0 is 5.0V ± 0.5V

Capacitance

| Symbol | Parameter | Typ | Units | Conditions |
|-----------------|-------------------------------|------|-------|------------------------|
| C _{IN} | Input Capacitance | 4.5 | pF | V _{CC} = OPEN |
| C _{PD} | Power Dissipation Capacitance | 30.0 | pF | V _{CC} = 5.0V |

Physical Dimensions inches (millimeters) unless otherwise noted

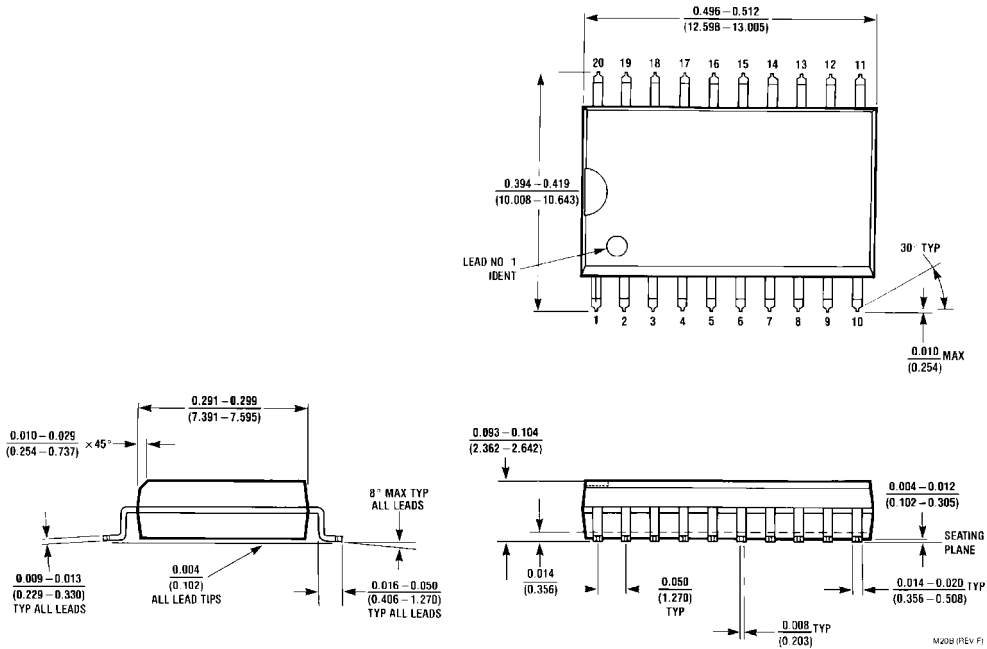

**20-Lead Small Outline Integrated Circuit (SOIC), JEDEC MS-013, 0.300" Wide
Package Number M20B**

Physical Dimensions inches (millimeters) unless otherwise noted (Continued)

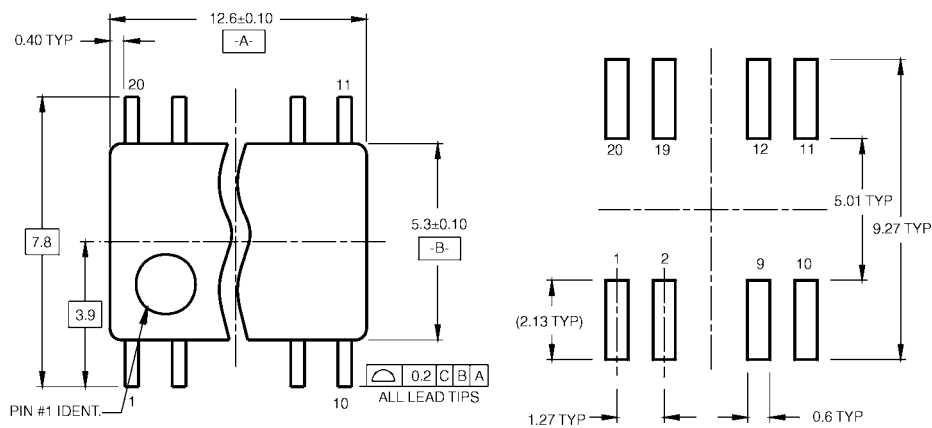

LAND PATTERN RECOMMENDATION



DIMENSIONS ARE IN MILLIMETERS

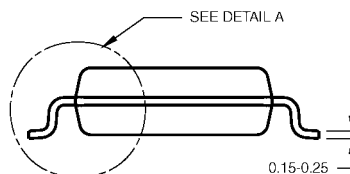

DETAIL A

- NOTES:
- A. CONFORMS TO EIAJ EDR-7320 REGISTRATION, ESTABLISHED IN DECEMBER, 1998.
 - B. DIMENSIONS ARE IN MILLIMETERS.
 - C. DIMENSIONS ARE EXCLUSIVE OF BURRS, MOLD FLASH, AND TIE BAR EXTRUSIONS.

M20DRevB1

**Pb-Free 20-Lead Small Outline Package (SOP), EIAJ TYPE II, 5.3mm Wide
Package Number M20D**

Physical Dimensions inches (millimeters) unless otherwise noted (Continued)

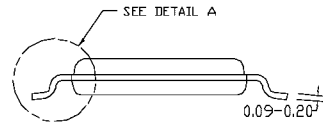
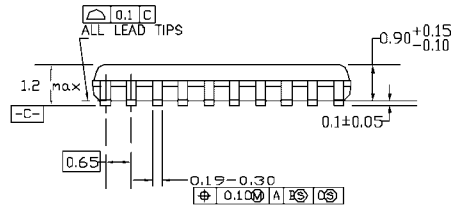
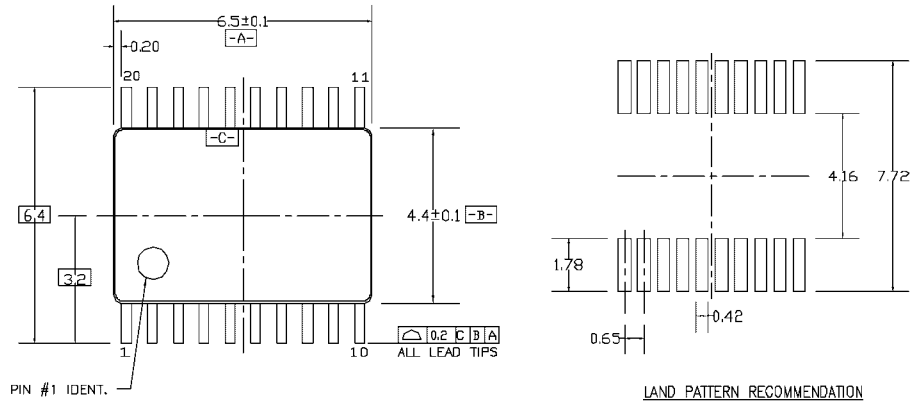

DIMENSIONS ARE IN MILLIMETERS

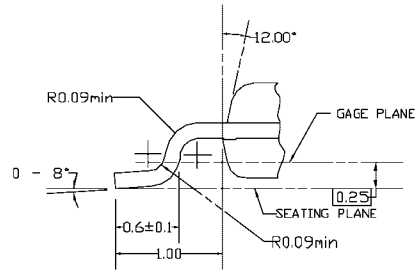

DETAIL A

NOTES:

- A. CONFORMS TO JEDEC REGISTRATION MO-153, VARIATION AC, REF NOTE 6, DATE 7/93.
- B. DIMENSIONS ARE IN MILLIMETERS.
- C. DIMENSIONS ARE EXCLUSIVE OF BURRS, MOLDS FLASH, AND TIE BAR EXTRUSIONS.
- D. DIMENSIONS AND TOLERANCES PER ANSI Y14.5M, 1982.

MTC20REV D1

**20-Lead Thin Shrink Small Outline Package (TSSOP), JEDEC MO-153, 4.4mm Wide
Package Number MTC20**

Physical Dimensions inches (millimeters) unless otherwise noted (Continued)

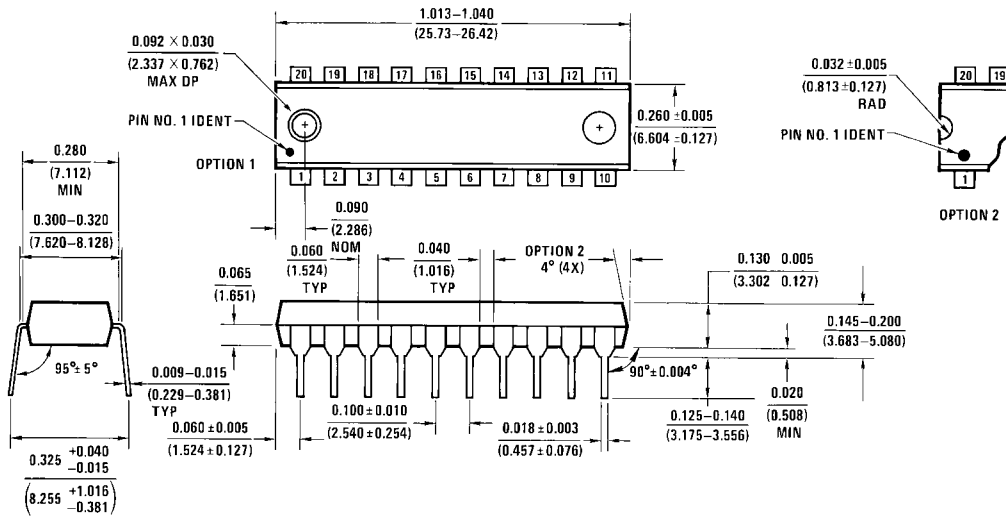

N20A (REV G)

**20-Lead Plastic Dual-In-Line Package (PDIP), JEDEC MS-001, 0.300" Wide
Package Number N20A**

Fairchild does not assume any responsibility for use of any circuitry described, no circuit patent licenses are implied and Fairchild reserves the right at any time without notice to change said circuitry and specifications.

LIFE SUPPORT POLICY

FAIRCHILD'S PRODUCTS ARE NOT AUTHORIZED FOR USE AS CRITICAL COMPONENTS IN LIFE SUPPORT DEVICES OR SYSTEMS WITHOUT THE EXPRESS WRITTEN APPROVAL OF THE PRESIDENT OF FAIRCHILD SEMICONDUCTOR CORPORATION. As used herein:

1. Life support devices or systems are devices or systems which, (a) are intended for surgical implant into the body, or (b) support or sustain life, and (c) whose failure to perform when properly used in accordance with instructions for use provided in the labeling, can be reasonably expected to result in a significant injury to the user.
2. A critical component in any component of a life support device or system whose failure to perform can be reasonably expected to cause the failure of the life support device or system, or to affect its safety or effectiveness.

www.fairchildsemi.com