

## SNUBBERLESS TRIACS

- $I_{TRMS} = 8\text{ A}$  at  $T_c = 90\text{ }^\circ\text{C}$ .
- $V_{DRM} : 200\text{ V}$  to  $800\text{ V}$ .
- $I_{GT} = 75\text{ mA}$  (QI-II-III).
- GLASS PASSIVATED CHIP.
- HIGH SURGE CURRENT :  $I_{TSM} = 80\text{ A}$ .
- HIGH COMMUTATION CAPABILITY :  
( $di/dt$ )<sub>c</sub> >  $10\text{ A/ms}$  without snubber.
- INSULATING VOLTAGE :  $2500\text{ V}_{RMS}$ .

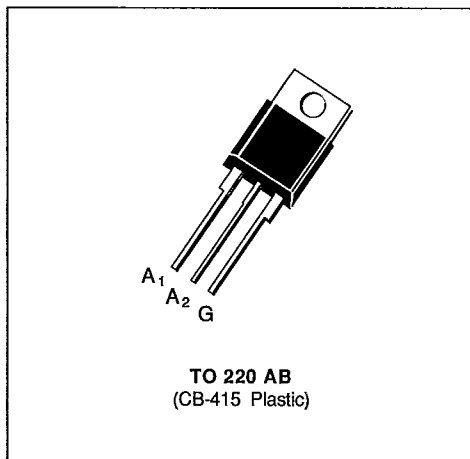

### DESCRIPTION

New range suited for applications such as phase control and static switching on inductive or resistive load.

### ABSOLUTE RATINGS (limiting values)

Symbol	Parameter		Value	Unit
$I_{TRMS}$	RMS on-state current (360 ° conduction angle)	$T_c = 90\text{ }^\circ\text{C}$	8	A
$I_{TSM}$	Non repetitive surge peak on-state current ( $T_J$ initial = $25\text{ }^\circ\text{C}$ )	$t = 8.3\text{ ms}$	85	A
		$t = 10\text{ ms}$	80	
$I^2t$	$I^2t$ value	$t = 10\text{ ms}$	32	$\text{A}^2\text{s}$
$di/dt$	Critical rate of rise of on-state current (1)	Repetitive $F = 50\text{ Hz}$	20	$\text{A}/\mu\text{s}$
		Non Repetitive	100	
$T_{stg}$ $T_J$	Storage and operating junction temperature range		- 40, + 150 - 40, + 125	$^\circ\text{C}$ $^\circ\text{C}$

Symbol	Parameter	BTA 08-					Unit
		200 AW	400 AW	600 AW	700 AW	800 AW	
$V_{DRM}$	Repetitive peak off-state voltage (2)	$\pm 200$	$\pm 400$	$\pm 600$	$\pm 700$	$\pm 800$	V

(1) Gate supply :  $I_G = 750\text{ mA}$  –  $di_G/dt = 1\text{ A}/\mu\text{s}$ .

(2)  $T_J = 125\text{ }^\circ\text{C}$ .

30E D ■ 7929237 0031501 &amp; ■

## THERMAL RESISTANCES

Symbol	Parameter	Value	Unit
$R_{th(j-a)}$	Junction to ambient	60	°C/W
$R_{th(j-c)}$ DC	Junction to case for DC	4.3	°C/W
$R_{th(j-c)}$ AC	Junction to case for 360° conduction angle (F = 50 Hz)	3.2	°C/W

## GATE CHARACTERISTICS (maximum values)

 $P_{GM} = 40 \text{ W (} t = 10 \mu\text{s)}$   $P_{G(AV)} = 1 \text{ W}$   $I_{GM} = 4 \text{ A (} t = 10 \mu\text{s)}$   $V_{GM} = 16 \text{ V (} t = 10 \mu\text{s)}$ 

SGS-THOMSON

## ELECTRICAL CHARACTERISTICS

Symbol	Test Conditions	Quadrants	Min.	Typ.	Max.	Unit	
$I_{GT}$	$T_j = 25 \text{ °C}$ $V_D = 12 \text{ V}$ $R_L = 33 \text{ } \Omega$ Pulse duration > 20 $\mu\text{s}$	I-II-III	2		75	mA	
$V_{GT}$	$T_j = 25 \text{ °C}$ $V_D = 12 \text{ V}$ $R_L = 33 \text{ } \Omega$ Pulse duration > 20 $\mu\text{s}$	I-II-III			1.5	V	
$V_{GD}$	$T_j = 125 \text{ °C}$ $V_D = V_{DRM}$ $R_L = 3.3 \text{ k}\Omega$ Pulse duration > 20 $\mu\text{s}$	I-II-III	0.2			V	
$I_H^*$	$T_j = 25 \text{ °C}$ $I_T = 100 \text{ mA}$ Gate open $R_L = 140 \text{ } \Omega$				75	mA	
$I_L$	$T_j = 25 \text{ °C}$ $V_D = 12 \text{ V}$ Pulse duration > 20 $\mu\text{s}$	I-III		75		mA	
		II		150			
$V_{TM}^*$	$T_j = 25 \text{ °C}$ $I_{TM} = 11 \text{ A}$ $t_p = 10 \text{ ms}$				1.75	V	
$I_{DRM}^*$	$T_j = 25 \text{ °C}$ $T_j = 125 \text{ °C}$	$V_{DRM}$ rated	Gate open			0.01	mA
						2	
$dv/dt^*$	$T_j = 125 \text{ °C}$ Gate open Linear slope up to 0.67 $V_{DRM}$		750	1000		V/ $\mu\text{s}$	
$(di/dt)_c^*$	$T_j = 125 \text{ °C}$ $V_{DRM}$ rated Without snubber		10	20		A/ms	
$t_{gt}$	$T_j = 25 \text{ °C}$ $di_G/dt = 3.5 \text{ A}/\mu\text{s}$ $I_G = 500 \text{ mA}$ $I_T = 11 \text{ A}$ $V_D = V_{DRM}$	I-II-III		2		$\mu\text{s}$	

\* For either polarity of electrode A<sub>2</sub> voltage with reference to electrode A<sub>1</sub>.

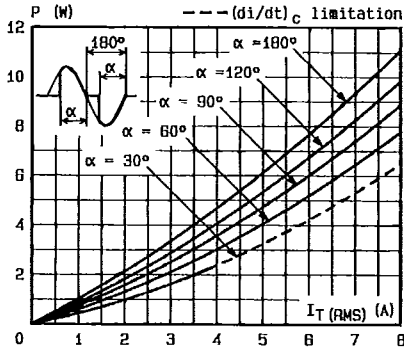

Fig. 1 - Maximum mean power dissipation versus RMS on-state current (F = 60 Hz).

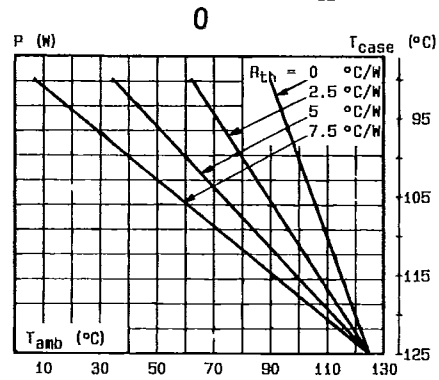

Fig. 2 - Correlation between maximum mean power dissipation and maximum allowable temperatures ( $T_{amb}$  and  $T_{case}$ ) for different thermal resistances heatsink + contact.

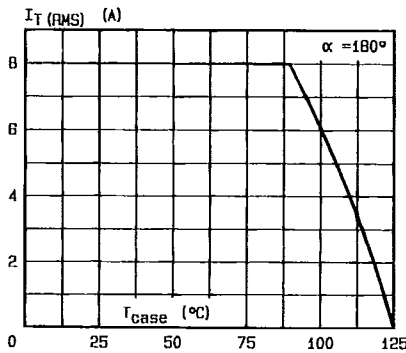

Fig. 3 - RMS on-state current versus case temperature.

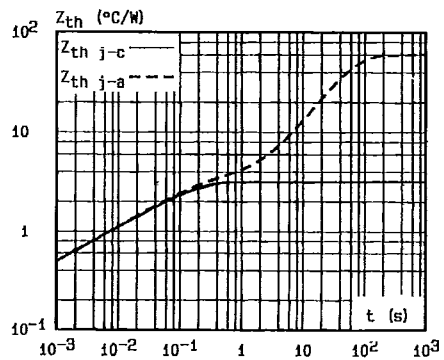

Fig. 4 - Thermal transient impedance junction to case and junction to ambient versus pulse duration.

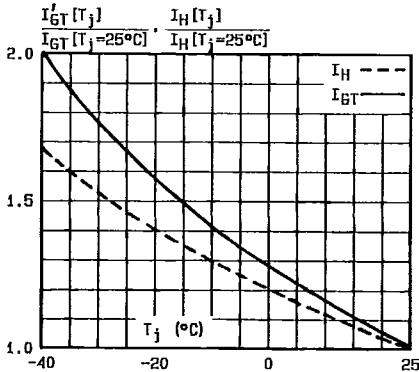

Fig. 5 - Relative variation of gate trigger current and holding current versus junction temperature.

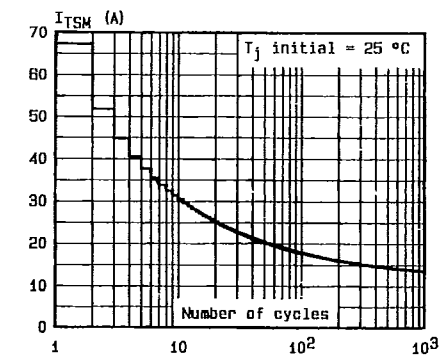

Fig. 6 - Non repetitive surge peak on-state current versus number of cycles.

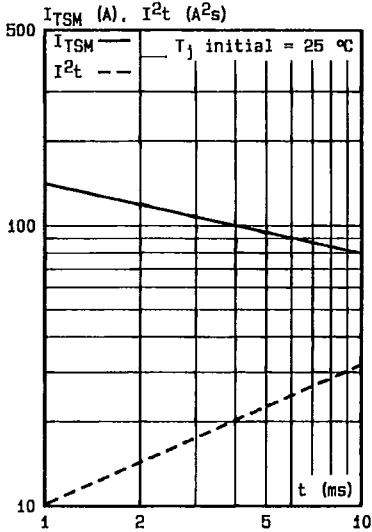

Fig.7 - Non repetitive surge peak on-state current for a sinusoidal pulse with width :  $t \leq 10$  ms, and corresponding value of  $I^2t$ .

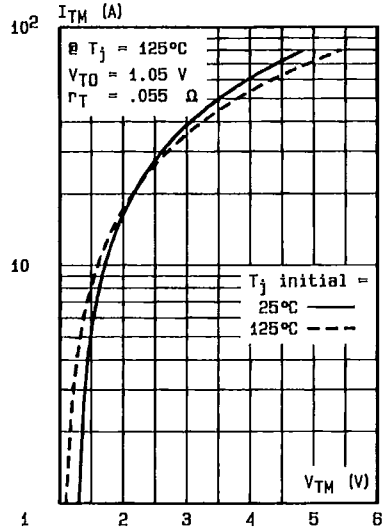
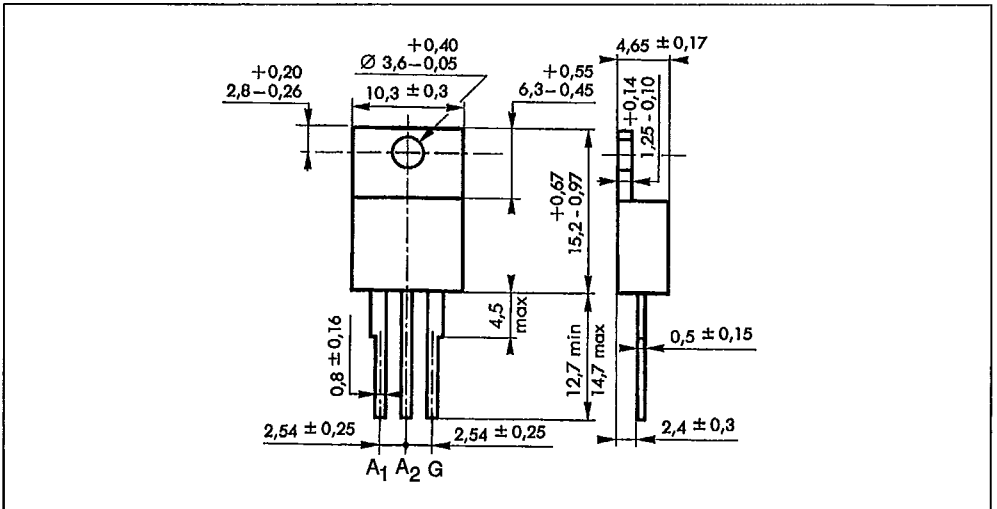

Fig.8 - On-state characteristics (maximum values).

PACKAGE MECHANICAL DATA

TO 220 AB (CB-415) Plastic



Cooling method : by conduction (method C)

Marking : type number

Weight : 2 g