

# NCP5393

## 2/3/4-Phase Controller for CPU Applications

The NCP5393 controls up to four  $V_{DD}$  phases and one  $V_{DDNB}$  phase to provide a buck regulator solution for current and next-generation AMD processors. The NCP5393 incorporates differential voltage sensing, differential phase current sensing, optional load-line voltage positioning, and programmable  $V_{DD}$  and  $V_{DDNB}$  offsets to provide accurately regulated power parallel- and serial-V<sub>ID</sub> AMD processors. Dual-edge multiphase modulation provides the fastest initial response to dynamic load events. This reduces system cost by requiring less bulk and ceramic output capacitance to meet transient regulation specifications.

High performance operational error amplifiers are provided to simplify compensation of the  $V_{DD}$  and  $V_{DDNB}$  regulators. Dynamic Reference Injection further simplifies loop compensation by eliminating the need to compromise between response to load transients and response to VID code changes.

### Features

- Meets AMD's Parallel, Serial (SVI) and Hybrid VR Specifications
- Up to Four  $V_{DD}$  Phases
- Single-Phase  $V_{DDNB}$  Controller
- Dual-Edge PWM for Fastest Initial Response to Transient Loading
- High Performance Operational Error Amplifiers
- Internal Soft Start and Slew Rate Limiting
- Dynamic Reference Injection (Patent #US07057381)
- DAC Range from 12.5 mV to 1.55 V
- $\pm 0.5\%$  DAC Accuracy from 0.8 V to 1.55 V
- $V_{DD}$  and  $V_{DDNB}$  Offset Ranges 0 mV – 800 mV
- True Differential Remote Voltage Sense Amplifiers
- Phase-to-Phase  $I_{DD}$  Current Balancing
- Differential Current Sense Amplifiers for Each Phase of Each Output
- “Lossless” Inductor Current Sensing for  $V_{DD}$  and  $V_{DDNB}$  Outputs
- Supports Load Lines (Droop) for  $V_{DD}$  and  $V_{DDNB}$  Outputs
- Oscillator Range of 100 kHz – 1 MHz
- Tracking Over Voltage Protection
- Output Inductor DCR-Based Over Current Protection for  $V_{DD}$  and  $V_{DDNB}$  Outputs
- Guaranteed Startup into Precharged Loads
- Temperature Range: 0°C to 70°C
- This is a Pb-Free Device\*

### Applications

- Desktop Processors
- Server Processors
- High-End Notebook PCs

\*For additional information on our Pb-Free strategy and soldering details, please download the ON Semiconductor Soldering and Mounting Techniques Reference Manual, SOLDERRM/D.



ON Semiconductor®

<http://onsemi.com>

### MARKING DIAGRAM

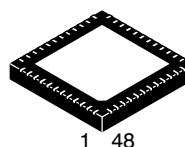

QFN48, 7x7  
CASE 485AJ

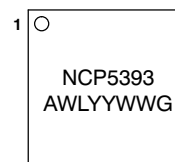

A = Assembly Location  
WL = Wafer Lot  
YY = Year  
WW = Work Week  
G = Pb-Free Package

### ORDERING INFORMATION

Device	Package	Shipping†
NCP5393MNR2G	QFN48 (Pb-Free)	2500 / Tape & Reel

†For information on tape and reel specifications, including part orientation and tape sizes, please refer to our Tape and Reel Packaging Specifications Brochure, BRD8011/D.

# NCP5393

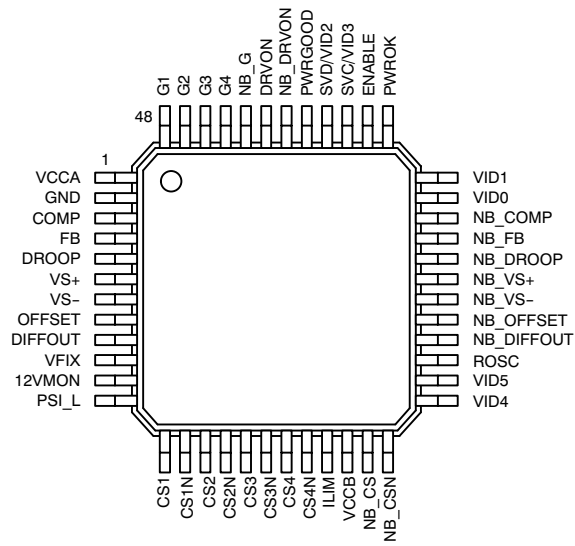

Figure 1. Pinout

# NCP5393

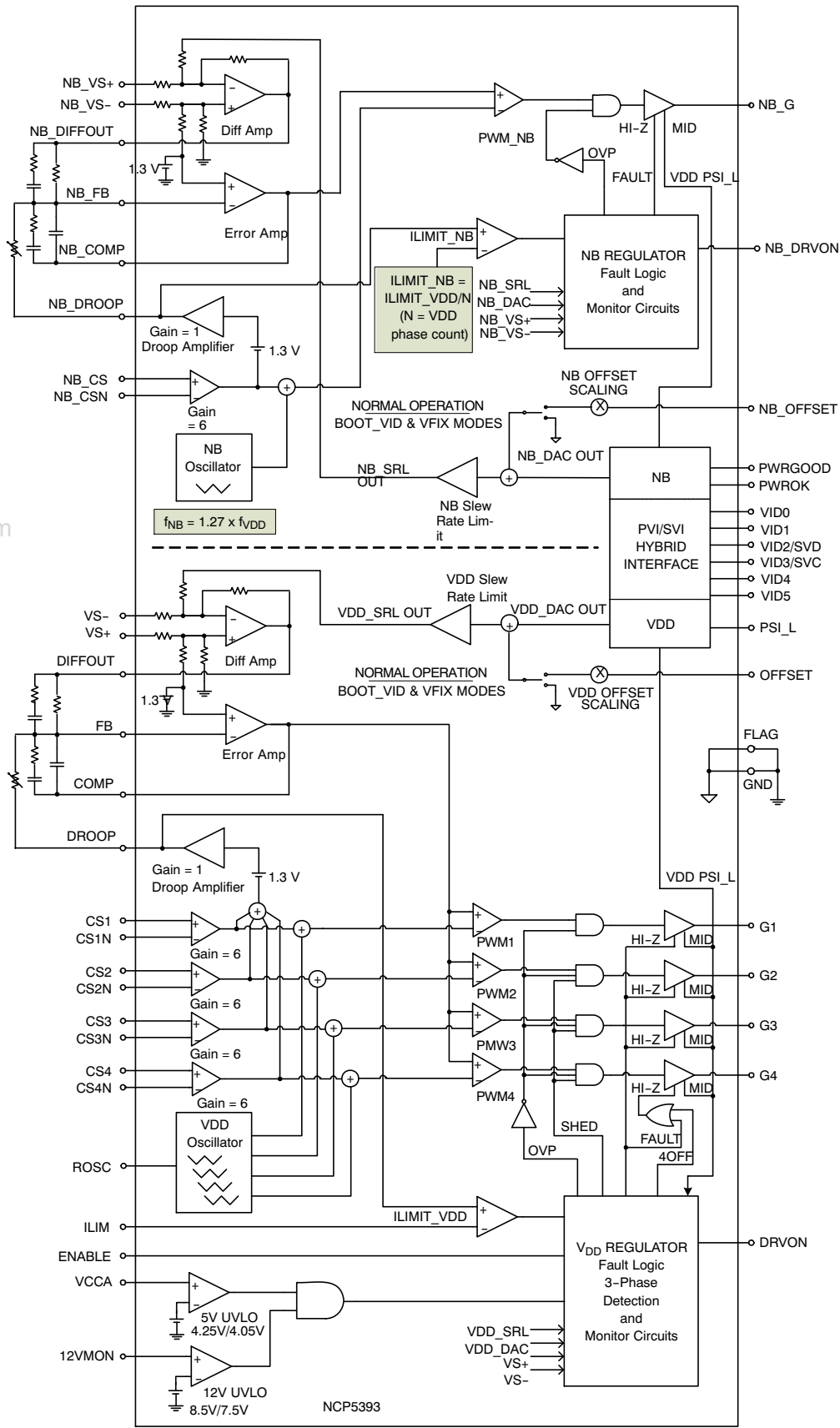

Figure 2. NCP5393 Block Diagram

# NCP5393

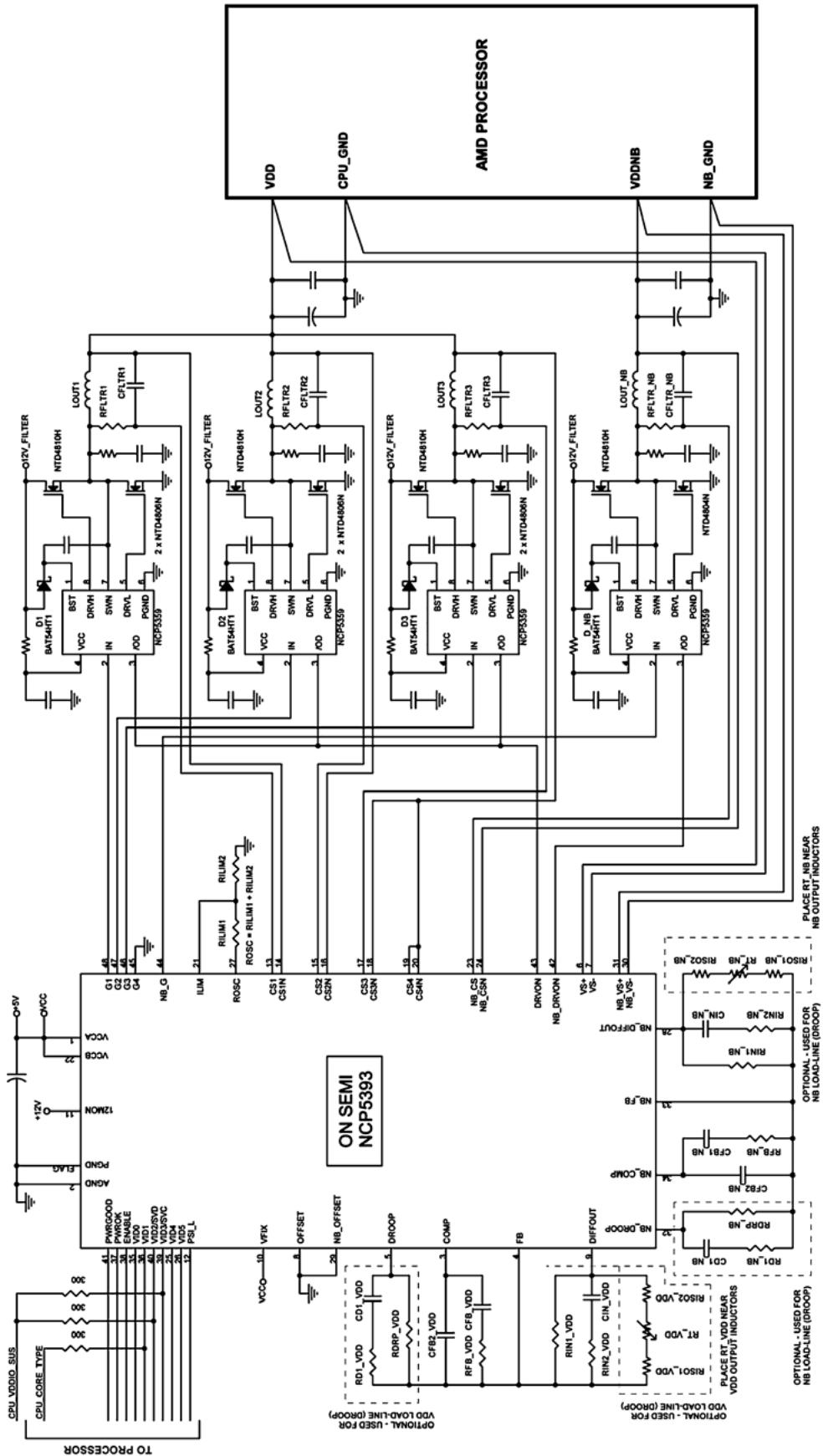

Figure 3. NCP5393 Configured for 3 + 1 Phases, with Optional Droop

# NCP5393

## NCP5393 PIN DESCRIPTIONS

Pin No.	Symbol	Description
1	VCCA	5 V supply pin for the NCP5393. The $V_{CC}$ bypassing capacitance must be connected between this pin and GND (preferably returned to the package flag).
2	GND	Small-signal power supply return. This pin should be tied directly to the package flag (exposed pad).
3	COMP	Output of the voltage error amplifier for the $V_{DD}$ regulator.
4	FB	Voltage error amplifier inverting input for the $V_{DD}$ regulator.
5	DROOP	Voltage output signal proportional to total current drawn from the $V_{DD}$ regulator. Used when load line operation ("droop") is desired.
6	VS+	Non-inverting input to the differential remote sense amplifier for the $V_{DD}$ regulator.
7	VS-	Inverting input to the differential remote sense amplifier for the $V_{DD}$ regulator.
8	OFFSET	Input for offset voltage to be added to the $V_{DD}$ DAC's output voltage. Ground this pin for zero $V_{DD}$ offset.
9	DIFFOUT	Output of the differential remote sense amplifier for the $V_{DD}$ regulator.
10	VFIX	When pulled low, this pin causes the levels on the SVC (VID3) and SVD (VID2) pins to be decoded as a two-bit DAC code, which controls the $V_{DD}$ and VDDNB outputs.
11	12VMON	UVLO monitor input for the 12 V power rail.
12	PSI_L	Power Saving Control. Low = single phase operation, High = normal operation. This pin is not used in SVI mode.
13	CS1	Non-inverting input to current sense amplifier #1 for the $V_{DD}$ regulator. See Table: "Pin Connections vs. Phase Count"
14	CS1N	Inverting input to current sense amplifier #1 for the $V_{DD}$ regulator. See Table: "Pin Connections vs. Phase Count"
15	CS2	Non-inverting input to current sense amplifier #2 for the $V_{DD}$ regulator. See Table: "Pin Connections vs. Phase Count"
16	CS2N	Inverting input to current sense amplifier #2 for the $V_{DD}$ regulator. See Table: "Pin Connections vs. Phase Count"
17	CS3	Non-inverting input to current sense amplifier #3 for the $V_{DD}$ regulator. See Table: "Pin Connections vs. Phase Count"
18	CS3N	Inverting input to current sense amplifier #3 for the $V_{DD}$ regulator. See Table: "Pin Connections vs. Phase Count"
19	CS4	Non-inverting input to current sense amplifier #4 for the $V_{DD}$ regulator. See Table: "Pin Connections vs. Phase Count"
20	CS4N	Inverting input to current sense amplifier #4 for the $V_{DD}$ regulator. See Table: "Pin Connections vs. Phase Count"
21	ILIM	Overcurrent shutdown threshold for $V_{DD}$ and VDDNB. A resistor divider from ROSC to GND is typically used to develop an appropriate voltage on ILIM.
22	VCCB	5 V supply pin. Tie this pin to VCCA (Pin 1).
23	NB_CS	Non-inverting input to the current sense amplifier for the VDDNB regulator
24	NB_CSN	Inverting input to the current sense amplifier for the VDDNB regulator
25	VID4	Parallel Voltage ID DAC Input 4. Not used in SVI mode.
26	VID5	Parallel Voltage ID DAC Input 5. Not used in SVI mode.
27	ROSC	A resistance from this pin to ground programs the $V_{DD}$ and VDDNB oscillator frequencies. This pin supplies a trimmed output voltage of 2 V.
28	NB_DIFFOUT	Output of the differential remote sense amplifier for the VDDNB regulator.
29	NB_OFFSET	Input for offset voltage to be added to the VDDNB DAC's output voltage. Ground this pin for zero VDDNB offset.
30	NB_VS-	Inverting input to the differential remote sense amplifier for the VDDNB regulator.
31	NB_VS+	Non-inverting input to the differential remote sense amplifier for the VDDNB regulator.

# NCP5393

## NCP5393 PIN DESCRIPTIONS

Pin No.	Symbol	Description
32	NB_DROOP	Voltage output signal proportional to total current drawn from the VDDNB regulator. Used when load line operation ("droop") is desired.
33	NB_FB	Voltage error amplifier inverting input for the VDDNB regulator.
34	NB_COMP	Output of the voltage error amplifier for the VDDNB regulator.
35	VID0	Parallel Voltage ID DAC Input 0. Not used in SVI mode.
36	VID1	Parallel Voltage ID DAC Input 1. Also used for PVI or SVI mode selection.
37	PWROK	System power supplies status input. Used in SVI mode only.
38	ENABLE	High = Run, Low = Standby/Reset.
39	VID3/SVC	Parallel Voltage ID DAC Input 1. Also used in SVI mode.
40	VID2/SVD	Parallel Voltage ID DAC Input 1. Also used in SVI mode.
41	PWRGOOD	Open drain output. High indicates that the active output(s) are within specification.
42	NB_DRVON	Bidirectional Gate Drive Enable to the gate driver for the VDDNB regulator.
43	DRVON	Bidirectional Gate Drive Enable to gate drivers for the VDD regulator.
44	NB_G	PWM output to the VDDNB gate driver.
45	G4	PWM output #4. See Table: "Pin Connections vs. Phase Count"
46	G3	PWM output #3. See Table: "Pin Connections vs. Phase Count"
47	G2	PWM output #2. See Table: "Pin Connections vs. Phase Count"
48	G1	PWM output #1. See Table: "Pin Connections vs. Phase Count"
FLAG	PGND	High-current power supply return via metal pad (flag) underneath package. The package flag should be tied directly to Pin 2.

## PIN CONNECTIONS VS. PHASE COUNT

Number of Phases	G4	G3	G2	G1	CS4 & CS4N	CS3 & CS3N	CS2 & CS2N	CS1 & CS1N
4	Phase 4 Out	Phase 3 Out	Phase 2 Out	Phase 1 Out	Phase 4 CS Input	Phase 3 CS Input	Phase 2 CS Input	Phase 1 CS Input
3	Tie to GND	Phase 3 Out	Phase 2 Out	Phase 1 Out	Tie to GND	Phase 3 CS Input	Phase 2 CS Input	Phase 1 CS Input
2	Tie to GND	Phase 2 Out	Tie to GND	Phase 1 Out	Tie to GND	Phase 2 CS input	Tie to GND	Phase 1 CS Input

# NCP5393

## ABSOLUTE MAXIMUM RATINGS ELECTRICAL INFORMATION

Pin Symbol	V <sub>MAX</sub>	V <sub>MIN</sub>	I <sub>SOURCE</sub>	I <sub>SINK</sub>
12VMON	13.2 V	-0.3 V	N/A	50 μA
VCC	7.0 V	-0.3 V	N/A	10 mA
COMP, NB_COMP	5.5 V	-0.3 V	10 mA	10 mA
DROOP, NB_DROOP	5.5 V	-0.3 V	5 mA	5 mA
DIFFOUT, NB_DIFFOUT	5.5 V	-0.3 V	20 mA	20 mA
DRVON, NB_DRVON	5.5 V	-0.3 V	5 mA	10 mA
PWRGOOD	5.5 V	-0.3 V	N/A	20 mA
VS+, NB_VS+	3 V	-0.3 V	1 mA	1 mA
VS-, NB_VS-	0.3 V	-0.3 V	1 mA	1 mA
ROSC	5.5 V	-0.3 V	1 mA	N/A
All Other Pins	5.5 V	-0.3 V	N/A	N/A

Stresses exceeding Maximum Ratings may damage the device. Maximum Ratings are stress ratings only. Functional operation above the Recommended Operating Conditions is not implied. Extended exposure to stresses above the Recommended Operating Conditions may affect device reliability.

NOTE: All signals are referenced to GND unless noted otherwise.

## THERMAL INFORMATION

Rating	Symbol	Value	Unit
Thermal Characteristic, QFN Package (Note 1)	R <sub>θJA</sub>	30.5	°C/W
Operating Junction Temperature Range (Note 2)	T <sub>J</sub>	0 to 125	°C
Operating Ambient Temperature Range	T <sub>A</sub>	0 to 70	°C
Maximum Storage Temperature Range	T <sub>STG</sub>	-55 to +150	°C
Moisture Sensitivity Level, QFN Package	MSL	1	

\* The maximum package power dissipation must be observed.

1. JESD 51-5 (1S2P Direct-Attach Method) with 0 LFM.
2. JESD 51-7 (1S2P Direct-Attach Method) with 0 LFM.

# NCP5393

## ELECTRICAL CHARACTERISTICS (Unless otherwise stated: $0^{\circ}\text{C} \leq T_A \leq 70^{\circ}\text{C}$ ; $4.75\text{ V} \leq V_{\text{CC}} \leq 5.25\text{ V}$ ; All DAC Codes; $C_{\text{VCC}} = 0.1\ \mu\text{F}$ )

Parameter	Test Conditions	Min	Typ	Max	Unit
<b>ERROR AMPLIFIERS</b> ( $V_{\text{DD}}$ & $V_{\text{DDNB}}$ )					
Input Bias Current		-200	-	200	nA
Input Offset Voltage (Note 3)	$V_+ = V_- = 1.3\text{ V}$	-1.0	-	1.0	mV
Open Loop DC Gain	$C_L = 60\ \text{pF}$ to GND, $R_L = 10\ \text{k}\Omega$ to GND	-	80	-	dB
Open Loop Unity Gain Bandwidth	$C_L = 60\ \text{pF}$ to GND, $R_L = 10\ \text{k}\Omega$ to GND	-	15	-	MHz
Open Loop Phase Margin	$C_L = 60\ \text{pF}$ to GND, $R_L = 10\ \text{k}\Omega$ to GND	-	70	-	deg
Slew Rate	$\Delta V_{\text{IN}} = 100\ \text{mV}$ , $A_V = -10\ \text{V/V}$ , $1.5\ \text{V} < V_{\text{COMP}} < 2.5\ \text{V}$ , $C_L = 60\ \text{pF}$ , DC Loading = $\pm 125\ \mu\text{A}$	-	5	-	V/ $\mu\text{s}$
Maximum Output Voltage	10 mV of Overdrive, $I_{\text{SOURCE}} = 2.0\ \text{mA}$	3.5	-	-	V
Minimum Output Voltage	10 mV of Overdrive, $I_{\text{SINK}} = 2.0\ \text{mA}$	-	-	1.0	V
Output Source Current (Note 3)	10 mV of Overdrive, $V_{\text{OUT}} = 3.5\ \text{V}$	-	2	-	mA
Output Sink Current (Note 3)	10 mV of Overdrive, $V_{\text{OUT}} = 1.0\ \text{V}$	-	2	-	mA

## DIFFERENTIAL SUMMING AMPLIFIERS ( $V_{\text{DD}}$ & $V_{\text{DDNB}}$ )

VS- Input Bias Current	VS- Voltage at 0 V		33		$\mu\text{A}$
VS+ Input Resistance	DRVON = Low		1.0		$\text{k}\Omega$
	DRVON = High		7		
VS+ Input Bias Voltage	DRVON = Low		0.37		V
	DRVON = High		0.05		
VS+ Input Voltage Range (Note 3)		-0.3	-	3.0	V
VS- Input Voltage Range (Note 3)		-0.3	-	0.3	V
-3dB Bandwidth (Note 3)	$C_L = 80\ \text{pF}$ to GND, $R_L = 10\ \text{k}\Omega$ to GND		15		MHz
DC gain, VS+ to DIFFOUT	VS+ to VS- = 0.5 V to 2.35 V	0.982	1.0	1.022	V/V
DAC Accuracy (Measured at VS+)	Closed Loop Measurement, Error Amplifier Inside the Loop. $1.0125\ \text{V} \leq V_{\text{DAC}} \leq 1.5500\ \text{V}$ $0.8000\ \text{V} \leq V_{\text{DAC}} \leq 1.0000\ \text{V}$ $12.5\ \text{mV} \leq V_{\text{DAC}} \leq 0.8000\ \text{V}$	-0.5 -5 -8	- - -	0.5 5 8	% mV mV
Slew Rate	$\Delta V_{\text{IN}} = 100\ \text{mV}$ , $\Delta V_{\text{OUT}} = 1.3\ \text{V} - 1.2\ \text{V}$		10		V/ $\mu\text{s}$
Maximum Output Voltage	$I_{\text{SOURCE}} = 2\ \text{mA}$	2.0			V
Minimum Output Voltage	$I_{\text{SINK}} = 2\ \text{mA}$			0.5	V
Output source current (Note 3)	$V_{\text{OUT}} = 3\ \text{V}$		2.0		mA
Output sink current (Note 3)	$V_{\text{OUT}} = 0.5\ \text{V}$		2.0		mA

## DROOP AMPLIFIERS ( $V_{\text{DD}}$ & $V_{\text{DDNB}}$ )

Gain from Current Sense Input to Droop Amplifier Output	$0\ \text{mV} < (CS_x - CS_{xN}) < 60\ \text{mV}$	5.7	6.0	6.3	V/V
Droop Amplifier DC Output Voltage	$CS_x = CS_{xN} = 1.3\ \text{V}$		1.3		V
Slew Rate	$C_L = 20\ \text{pF}$ to GND, $R_L = 1\ \text{k}\Omega$ to GND	-	5.0	-	V/ $\mu\text{s}$
Maximum Output Voltage	$I_{\text{SOURCE}} = 4.0\ \text{mA}$	3.0	-	-	V
Minimum Output Voltage	$I_{\text{SINK}} = 1.0\ \text{mA}$	-	-	1.0	V
Output Source Current (Note 3)	$V_{\text{OUT}} = 3.0\ \text{V}$	-	4.0	-	mA
Output Sink Current (Note 3)	$V_{\text{OUT}} = 1.0\ \text{V}$		1.0	-	mA

3. Guaranteed by design. Not production tested.



# NCP5393

## ELECTRICAL CHARACTERISTICS (Unless otherwise stated: $0^{\circ}\text{C} \leq T_A \leq 70^{\circ}\text{C}$ ; $4.75\text{ V} \leq V_{\text{CC}} \leq 5.25\text{ V}$ ; All DAC Codes; $C_{\text{VCC}} = 0.1\ \mu\text{F}$ )

Parameter	Test Conditions	Min	Typ	Max	Unit
<b>CURRENT SENSE AMPLIFIERS (<math>V_{\text{DD}}</math> &amp; <math>V_{\text{DDNB}}</math>)</b>					
Input Bias Current	$\text{CSx} = \text{CSxN} = 1.4\text{ V}$	-50	-	50	nA
Common Mode Input Voltage Range		-0.3	-	2.6	V
Differential Mode Input Voltage Range (Note 3)		-120	-	120	mV
Input Offset Voltage (Note 3)	$\text{CSx} = \text{CSxN} = 1.00\text{ V}$	-1.0	-	1.0	mV
Gain from Current Sense Input to PWM Comparator	$0\text{ mV} < (\text{CSx} - \text{CSxN}) < 60\text{ mV}$	5.0	6.0	7.0	V/V
<b>INTERNAL OFFSET VOLTAGE</b>					
Voltage at Error Amplifier Non-Inverting Inputs		-	1.3	-	V
<b>DRVON &amp; NB_DRVON</b>					
Output Voltage (High)	Sourcing $500\ \mu\text{A}$	3.0	-	-	V
Output Voltage (Low)	Sinking $500\ \mu\text{A}$	-	-	0.7	V
Delay Time	Propagation Delays	-	10	-	ns
Active Internal Pull-up Resistance	Sourcing $500\ \mu\text{A}$	-	2.0	-	k $\Omega$
Active Internal Pull-down Resistance	Sinking $500\ \mu\text{A}$	-	150	-	$\Omega$
Rise Time	$C_L (\text{PCB}) = 20\ \text{pF}$ , $\Delta V_{\text{OUT}} = 10\%$ to $90\%$	-	130	-	ns
Fall Time	$C_L (\text{PCB}) = 20\ \text{pF}$ , $\Delta V_{\text{OUT}} = 10\%$ to $90\%$	-	15	-	ns
<b><math>V_{\text{DD}}</math> PWM OSCILLATOR</b>					
Switching Frequency Range		100	-	900	kHz
Switching Frequency Accuracy 2- or 4-phase	ROSC = 49.9 k $\Omega$ ROSC = 24.9 k $\Omega$ ROSC = 10 k $\Omega$	196 380 803	- - -	226 420 981	kHz
Switching Frequency Accuracy 3-phase	ROSC = 49.9 k $\Omega$ ROSC = 24.9 k $\Omega$ ROSC = 10 k $\Omega$	196 380 803	- - -	226 420 981	kHz
ROSC Output Voltage	$10\ \mu\text{A} \leq \text{IROSC} \leq 200\ \mu\text{A}$	1.94	2.0	2.06	V
<b><math>V_{\text{DDNB}}</math> PWM OSCILLATOR</b>					
Switching Frequency		-	1.25	-	$\times f_{\text{VDD}}$
<b>PWM COMPARATORS (<math>V_{\text{DD}}</math> &amp; <math>V_{\text{DDNB}}</math>)</b>					
Minimum Pulse Width (Note 3)	$F_{\text{SW}} = 800\ \text{kHz}$	-	30	-	ns
Propagation Delay (Note 3)	$\pm 20\ \text{mV}$ of Overdrive	-	10	-	ns
Magnitude of the PWM Ramp		-	1.0	-	V
0% Duty Cycle	COMP Voltage at which the PWM Outputs Remain LOW	-	0.2	-	V
100% Duty Cycle	COMP Voltage at which the PWM Outputs Remain HIGH	-	1.2	-	V
PWM Phase Angle Error	Between Adjacent Phases	-15		+15	$^{\circ}$
<b>PWRGOOD OUTPUT</b>					
PWRGOOD Output Voltage (Low)	$I_{\text{PGD}} = 5\ \text{mA}$	-	-	0.4	V
PWRGOOD Rise Time	External Pullup of 1 k $\Omega$ to 5 V $C_{\text{TOTAL}} = 45\ \text{pF}$ , $\Delta V_{\text{OUT}} = 10\%$ to $90\%$	-	125	-	ns
PWRGOOD High-State Leakage	$V_{\text{PWRGOOD}} = 5.25\text{ V}$	-	-	1	$\mu\text{A}$

3. Guaranteed by design. Not production tested.

# NCP5393

## ELECTRICAL CHARACTERISTICS (Unless otherwise stated: $0^{\circ}\text{C} \leq T_A \leq 70^{\circ}\text{C}$ ; $4.75\text{ V} \leq V_{\text{CC}} \leq 5.25\text{ V}$ ; All DAC Codes; $C_{\text{VCC}} = 0.1\ \mu\text{F}$ )

Parameter	Test Conditions	Min	Typ	Max	Unit
-----------	-----------------	-----	-----	-----	------

### PWRGOOD OUTPUT

PWRGOOD Upper Threshold	$V_{\text{OUT}}$ Increasing, DAC = 1.3 V (Wrt DAC)	-	300	-	mV
PWRGOOD Lower Threshold	$V_{\text{OUT}}$ Decreasing, DAC = 1.3 V	-	350	-	mV

### PWM OUTPUTS ( $V_{\text{DD}}$ & $V_{\text{DDNB}}$ )

Output Voltage (High)	Sourcing 500 $\mu\text{A}$	3.0	-	$V_{\text{CC}}$	V
Output Voltage (Mid)	$R_L = 4\ \text{k}\Omega$ to GND	1.3	1.5	1.7	V
Output Voltage (Low)	Sinking 500 $\mu\text{A}$	-	-	0.15	V
Rise and Fall Times	$C_L = 50\ \text{pF}$ , 0.7 V to 3.0 V or 3.0 V to 0.7 V	-	15	-	ns
Tri-State Output Leakage	$G_x = 2.5\ \text{V}$ ( $x = 1-4$ or NB)	-1.5	-	1.5	$\mu\text{A}$
Output Impedance - HIGH or LOW State	Resistance to $V_{\text{CC}}$ or GND	-	50	-	$\Omega$

### VDD REGULATOR 2/3/4 PHASE DETECTION

Gate Pin Source Current		-	80	-	$\mu\text{A}$
Gate Pin Threshold Voltage		-	250	-	mV
Phase Detect Timer		-	20	-	$\mu\text{s}$

### SLEW RATE LIMITERS

Soft Start Ramp Time	DAC = 0 to DAC = BOOT_VID	-	2	-	ms
Slew Rate Limit	In Any Mode after Soft-Start Completes	-	3.25	-	mV/ $\mu\text{s}$

### VID INPUTS (Note: In SVI Mode, VID[2] = Bidirectional "SVD" Line and VID[3] = "SVC" Clock Input)

VID Input Voltage (High)	$V_{\text{HIGH}}$	0.9	-	-	V
VID Input Voltage (Low)	$V_{\text{LOW}}$	-	-	0.6	V
VID Hysteresis	$V_{\text{HIGH}} - V_{\text{LOW}}$ or $V_{\text{LOW}} - V_{\text{HIGH}}$	-	100	-	mV
Input Pulldown Current	$V_{\text{IN}} = 0.6\ \text{V} - 1.9\ \text{V}$	-	15	-	$\mu\text{A}$
SVD Output Voltage (Low)	In SVI Mode, $I_{\text{SINK}} = 5\ \text{mA}$	0	-	0.25	V

### ENABLE INPUT

ENABLE Input Voltage (High)	$V_{\text{HIGH}}$	2.0	-	-	V
ENABLE Input Voltage (Low)	$V_{\text{LOW}}$	-	-	0.8	V
Enable Hysteresis	Low - High or High - Low	-	200	-	mV
Enable Input Pull-Up Current	Internal Pullup to $V_{\text{CC}}$	-	15	-	$\mu\text{A}$

### VFIXEN INPUT (Active-Low Input)

VFIXEN Input Voltage (High)	$V_{\text{HIGH}}$	0.9	-	-	V
VFIXEN Input Voltage (Low)	$V_{\text{LOW}}$	-	-	0.6	V
VFIXEN Hysteresis	Low - High or High - Low	-	100	-	mV
VFIXEN Input Pull-Up Current	Internal Pullup to $V_{\text{CC}}$	-	15	-	$\mu\text{A}$

3. Guaranteed by design. Not production tested.

# NCP5393

## ELECTRICAL CHARACTERISTICS (Unless otherwise stated: $0^{\circ}\text{C} \leq T_A \leq 70^{\circ}\text{C}$ ; $4.75\text{ V} \leq V_{\text{CC}} \leq 5.25\text{ V}$ ; All DAC Codes; $C_{\text{VCC}} = 0.1\ \mu\text{F}$ )

Parameter	Test Conditions	Min	Typ	Max	Unit
-----------	-----------------	-----	-----	-----	------

### PSI\_L (Power Saving Control, Active Low) (This pin is used in PVI mode only)

PSI_L Input Voltage (High)	$V_{\text{HIGH}}$	0.9	-	-	V
PSI_L Input Voltage (Low)	$V_{\text{LOW}}$	-	-	0.6	V
PSI_L Hysteresis	$V_{\text{HIGH}} - V_{\text{LOW}}$ or $V_{\text{LOW}} - V_{\text{HIGH}}$		100		mV

### CURRENT LIMIT

Current Sense Amp to ILIM Gain	$20\text{ mV} < (\text{CSx} - \text{CSxN}) < 60\text{ mV}$ (CS inputs tied)	5.7	6.0	6.3	V/V
ILIM Pin Input Bias Current		-	-	0.5	$\mu\text{A}$
ILIM Pin Working Voltage Range (Note 3)		0.2	-	2.0	V
ILIM Offset Voltage	Offset extrapolated to $\text{CSx} - \text{CSxN} = 0\text{ V}$ , and referred to the ILIM pin	-	30	-	mV
Delay		-	600	-	ns
VDDNB Current Limit Coefficient	$= N \times V_{\text{NBILIM}} / V_{\text{ILIM}}$ , where N = number of VDD phases, and $V_{\text{NBILIM}}$ is the equivalent voltage threshold for NB Current Limit resulting from $V_{\text{ILIM}}$ .		1.0		V

### OFFSET INPUTS ( $V_{\text{DD}}$ & $V_{\text{DDNB}}$ )

Output Offset Voltage Above VDAC		0	-	800	mV
----------------------------------	--	---	---	-----	----

### OUTPUT OVERVOLTAGE PROTECTION ( $V_{\text{DD}}$ & $V_{\text{DDNB}}$ )

Over Voltage Threshold	In normal operation, with no VID changes			$V_{\text{DAC}} + 250$	mV
------------------------	--	--	--	------------------------	----

### VCCA UNDERVOLTAGE PROTECTION

VCCA UVLO Start Threshold		4.0	4.25	4.5	V
VCCA UVLO Stop Threshold		3.8	4.05	4.3	V
VCCA UVLO Hysteresis			200		mV

### INPUT SUPPLY CURRENT

VCC Operating Current	ENABLE held Low, No PWM operation	-	25	35	mA
-----------------------	-----------------------------------	---	----	----	----

### 12VMON

12VMON (High Threshold)		8	8.5	9	V
12VMON (Low Threshold)		7	7.5	8	V
12VMON Hysteresis	Low - High or High - Low		1.0		V

3. Guaranteed by design. Not production tested.

TYPICAL CHARACTERISTICS

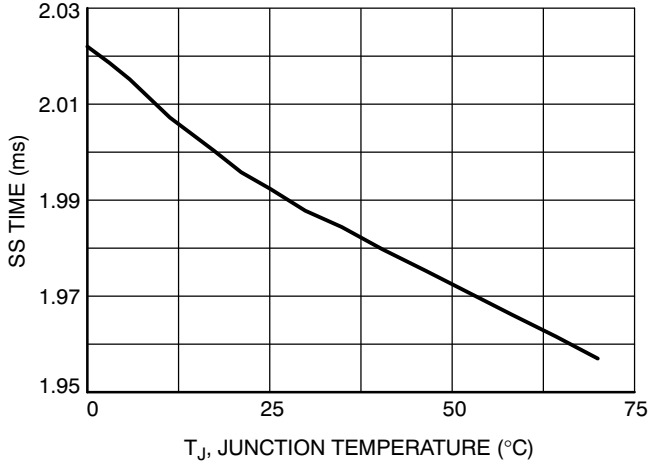

Figure 1. SS Time vs. Temperature

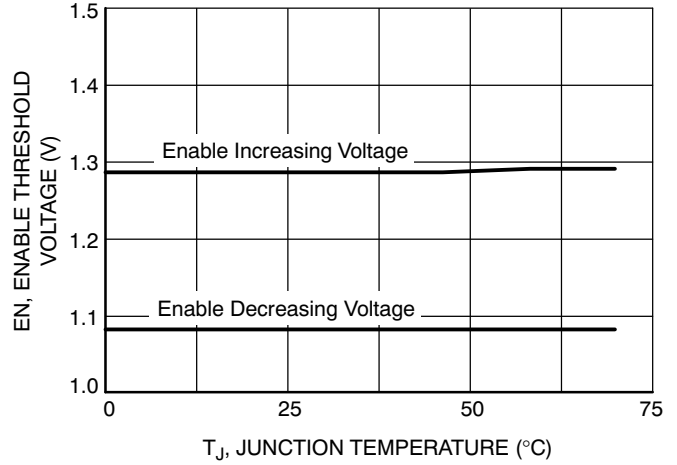

Figure 2. Enable Threshold Voltage vs. Temperature

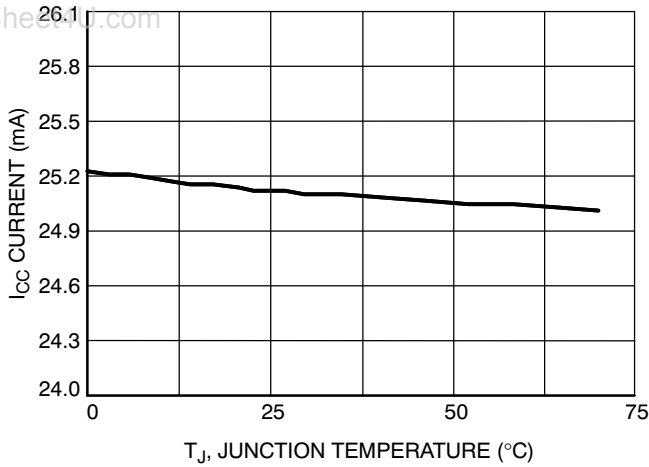

Figure 3. I<sub>CC</sub> Current vs. Temperature

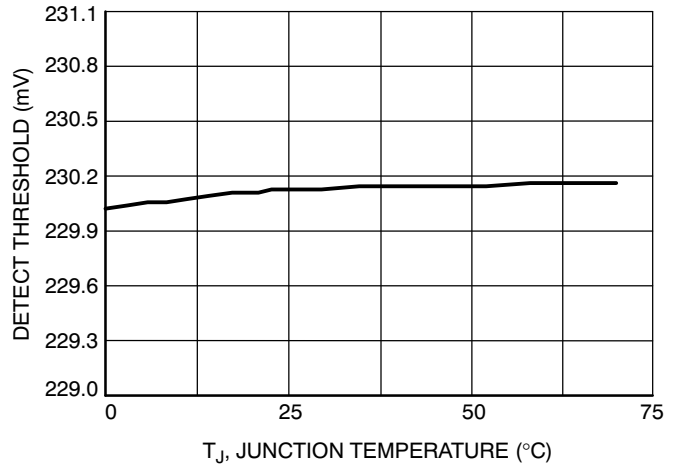

Figure 4. 2/3/4 Phase Detection Threshold vs. Temperature

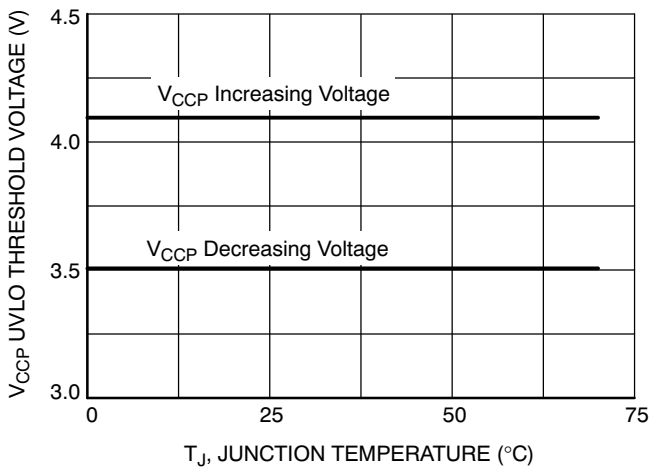

Figure 5. V<sub>CCP</sub> Undervoltage Lockout Threshold Voltage vs. Temperature

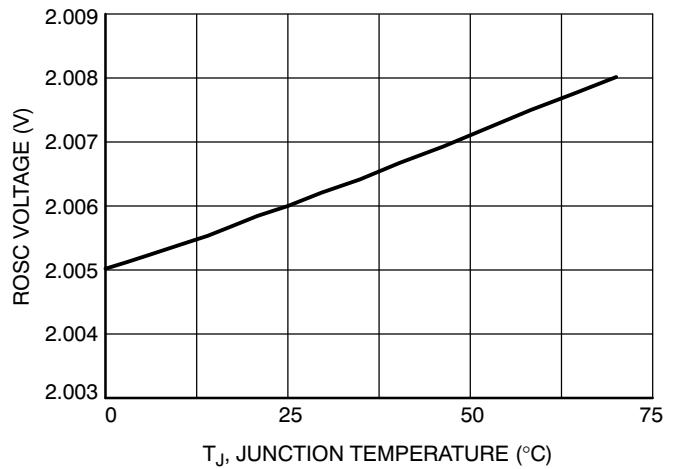

Figure 6. ROSC Voltage vs. Temperature

TYPICAL CHARACTERISTICS

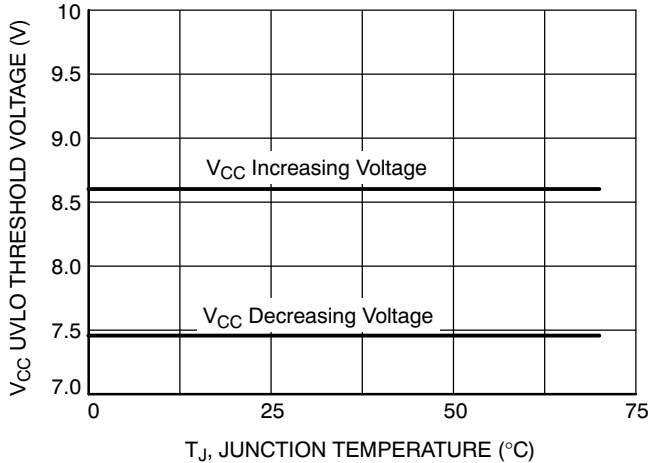

Figure 7. 12VMON Undervoltage Lockout Threshold Voltage vs. Temperature

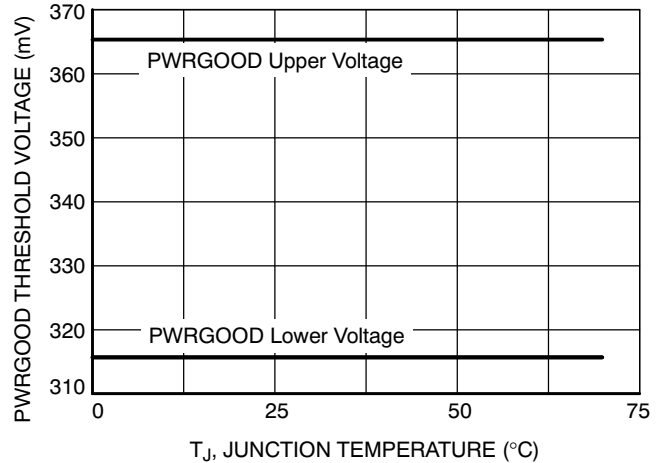

Figure 8. PWRGOOD Voltage vs. Temperature

Functional Description

General

NCP5393 is an universal CPU Power Supply Controller compatible with both Parallel (PVI) and Serial (SVI) protocols for AMD Processors. The device provides complete control logic and protections for a high-performance step-down DC-DC voltage regulator, optimized for advanced microprocessor power supply supporting both PVI and SVI communication. It embeds two independent controllers for CPU CORE and the integrated NB, each one with its set of protections. The Controller performs a single-phase control for the NB Section and a programmable 2- to-4 phase control for the CORE Section featuring Dual-Edge multiphase architecture.

NCP5393 also supports V\_FIX mode for board debug: in this particular configuration the SVI bus is used as a static bus configuring 4 operative voltages for both the sections and ignoring any serial-VID command. It can be used for the board debug before plugging-in the CPU.

The NCP5393 incorporates differential voltage sensing, differential phase current sensing, optional load-line voltage positioning, and programmable VDD and VDDNB offsets to provide accurately regulated power parallel- and serial-VID AMD processors. Dual-edge multiphase modulation provides the fastest initial response to dynamic load events.

NCP5393 is able to detect which kind of CPU is connected in order to configure itself to work as a Single-Plane PVI controller or Dual-Plane SVI controller. The NCP5393 manages On the Fly VID transitions and maintains the slew rates as defined when the transitions take place. NCP5393 is available in TQFN48 Package.

Remote Output Sensing Amplifier (RSA)

A true differential amplifier allows the NCP5393 to measure V<sub>core</sub> voltage feedback with respect to the V<sub>core</sub> ground reference point by connecting the V<sub>core</sub> reference point to VSP,

and the V<sub>core</sub> ground reference point to VSN. This configuration keeps ground potential differences between the local controller ground and the V<sub>core</sub> ground reference point from affecting regulation of V<sub>core</sub> between V<sub>core</sub> and V<sub>core</sub> ground reference points. The RSA also subtracts the DAC (minus VID offset) voltage, thereby producing an unamplified output error voltage at the DIFFOUT pin. This output also has a 1.3 V bias voltage as the floating ground to allow both positive and negative error voltages.

Precision Programmable DAC

A precision programmable DAC is provided and system trimmed. This DAC has 0.5% accuracy over the entire operating temperature range of the part. The DAC can be programmed to support both PVI and SVI VID code specifications.

High Performance Voltage Error Amplifier

The error amplifier is designed to provide high slew rate and bandwidth. Although not required when operating as the controller of a voltage regulator, a capacitor from COMP to VFB is required for stable unity gain test configurations.

Gate Driver Outputs and 2/3/4 Phase Operation

The part can be configured to run in 2-, 3-, or 4-phase mode. In 2-phase mode, phases 1 and 3 should be used to drive the external gate drivers, G2 and G4 must be grounded. In 3-phase mode, gate output G4 must be grounded. In 4-phase mode all 4 gate outputs are used as shown in the 4-phase Applications Schematic. The Current Sense inputs of unused channels should be connected to GND. Please refer to table “PIN CONNECTIONS vs. PHASE COUNTS” for details.

**Differential Current Sense Amplifiers and Summing Amplifier**

Four differential amplifiers are provided to sense the output current of each phase. The inputs of each current sense amplifier must be connected across the current sensing element of the phase controlled by the corresponding gate output (G1, G2, G3, or G4). If a phase is unused, the differential inputs to that phase’s current sense amplifier must be shorted together and connected to the GND.

The current signals sensed from inductor DCR are fed into a summing amplifier to have a summed-up output. The outputs of current sense amplifiers control three functions. First, the summing current signal of all phases will go through DROOP amplifier and join the voltage feedback loop for output voltage positioning. Second, the output signal from DROOP amplifier also goes to ILIM amplifier to monitor the output current limit. Finally, the individual phase current contributes to the current balance of all phases by offsetting their ramp signals of PWM comparators.

**Oscillator and Triangle Wave Generator**

The controller embeds a programmable precision dual-Oscillator: one section is used for the CORE and it is a multiphase programmable oscillator managing equal phase-shift among all phases and the other section is used for the NB section. The oscillator’s frequency is programmed by the resistance connected from the ROSC pin to ground. The user will usually form this resistance from two resistors in order to create a voltage divider that uses the ROSC output voltage as the reference for creating the current limit setpoint voltage. The oscillator frequency range is 100\_kHz per phase to 1.0\_MHz per phase. The

oscillator generates up to 4 symmetrical triangle waveforms with amplitude between 1.3\_V and 2.3\_V. The triangle waves have a phase delay between them such that for 2-, 3- and 4-phase operation the PWM outputs are separated by 180, 120, and 90 angular degrees, respectively.

When the NB phase is enabled, in order to ensure that the VDDNB oscillator does not accidentally lock to the VDD oscillator, the VDDNB oscillator will free-run at a frequency which is nominally 1.25 ratio of  $f_{VDD}$ .

**CPU Support**

NCP5393 is able to detect the CPU it is going to supply and configure itself accordingly. At system Start-up, on the rising-edge of the EN signal, the device monitors the status of VID1 and switches in PVI mode (VID1 = 1) or SVI mode (VID1 = 0). When in PVI mode, NCP5393 uses the information available on the VID[0:5] bus to address the CORE Section output voltage. NB Section is kept in HiZ mode. When in SVI mode, NCP5393 discards the information available on VID0, VID4 and VID5 and uses VID2 and VID3 for SVC and SVD respectively.

**PVI – Parallel Interface**

PVI is a 6-bit-wide parallel interface used to address the CORE Section reference. According to the selected code, the device sets the CORE Section reference and regulates its output voltage. NB Section is kept in HiZ; no activity is performed on this section. furthermore, PWROK information is ignored as well since the signal is proprietary of the SVI protocol. Start-up sequences before soft start and after soft start are given in Figure 9. Voltage identifications for the 6Bit AMD mode is given in Table 1.

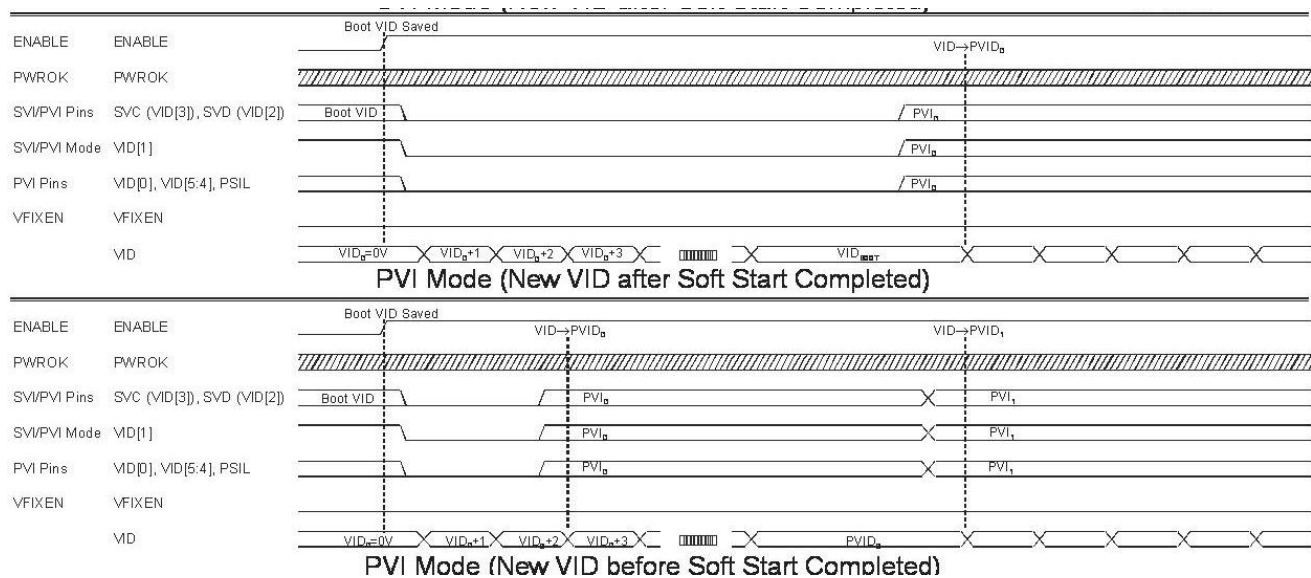

**Figure 9. Power Up Sequences Before and After Soft Start in PVI Mode**

Table 1. SIX-BIT PARALLEL VID CODES in PVI Modes

SVID[5:0]	V <sub>OUT</sub> (V)	SVID[5:0]	V <sub>OUT</sub> (V)	SVID[5:0]	V <sub>OUT</sub> (V)	SVID[5:0]	V <sub>OUT</sub> (V)
00_0000	1.5500	01_0000	1.1500	10_0000	0.7625	11_0000	0.5625
00_0001	1.5250	01_0001	1.1250	10_0001	0.7500	11_0001	0.5500
00_0010	1.5000	01_0010	1.1000	10_0010	0.7375	11_0010	0.5375
00_0011	1.4750	01_0011	1.0750	10_0011	0.7250	11_0011	0.5250
00_0100	1.4500	01_0100	1.0500	10_0100	0.7125	11_0100	0.5125
00_0101	1.4250	01_0101	1.0250	10_0101	0.7000	11_0101	0.5000
00_0110	1.4000	01_0110	1.0000	10_0110	0.6875	11_0110	0.4875
10_0111	1.3750	01_0111	0.9750	10_0111	0.6750	11_0111	0.4750
00_1000	1.3500	01_1000	0.9500	10_1000	0.6625	11_1000	0.4625
00_1001	1.3250	01_1001	0.9250	10_1001	0.6500	11_1001	0.4500
00_1010	1.3000	01_1010	0.9000	10_1010	0.6325	11_1010	0.4375
00_1011	1.2750	01_1011	0.8750	10_1011	0.6250	11_1011	0.4250
00_1100	1.2500	01_1100	0.8500	10_1100	0.6125	11_1100	0.4125
00_1101	1.2250	10_1101	0.8250	10_1101	0.6000	11_1101	0.4000
00_1110	1.2000	01_1110	0.8000	10_1110	0.5875	11_1110	0.3875
00_1111	1.1750	01_1111	0.7750	10_1111	0.5750	11_1111	0.3750

**SVI – Serial Interface**

SVI is a two wire, Clock and Data, bus that connects a single master (AMD processor) to one NCP5393. The master initiates and terminates SVI transactions and drives the clock, SVC, and the data SVD, during a transaction. The slave receives the SVI transactions and acts accordingly. SVI wire protocol is based on fast-mode I2C. The SVI communications are given in Figure 10.

SVI interface also considers EN and PWROK signals for start-up. The device returns a PWRGOOD signal if the output voltages are in regulation. The VID codes for SVI are given in Table 2.

The start-up sequences before and after soft start are given in Figure 11.

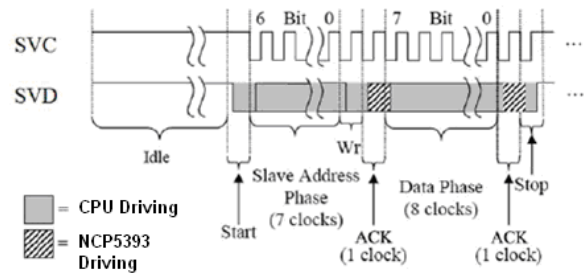

Figure 10. SVI Communication – Send Byte

# NCP5393

**Table 2. SEVEN-BIT SERIAL VID CODES for SVI Mode**

SVID[6:0]	V <sub>OUT</sub> (V)	SVID[6:0]	V <sub>OUT</sub> (V)	SVID[6:0]	V <sub>OUT</sub> (V)	SVID[6:0]	V <sub>OUT</sub> (V)
000_0000	1.5500	010_0000	1.1500	100_0000	0.7500	110_0000	0.3500
000_0001	1.5375	010_0001	1.1375	100_0001	0.7375	110_0001	0.3375
000_0010	1.5250	010_0010	1.1250	100_0010	0.7250	110_0010	0.3250
000_0011	1.5125	010_0011	1.1125	100_0011	0.7125	110_0011	0.3125
000_0100	1.5000	010_0100	1.1000	100_0100	0.7000	110_0100	0.3000
000_0101	1.4875	010_0101	1.0875	100_0101	0.6875	110_0101	0.2875
000_0110	1.4750	010_0110	1.0750	100_0110	0.6750	110_0110	0.2750
000_0111	1.4625	010_0111	1.0625	100_0111	0.6625	110_0111	0.2625
000_1000	1.4500	010_1000	1.0500	100_1000	0.6500	110_1000	0.2500
000_1001	1.4375	010_1001	1.0375	100_1001	0.6325	110_1001	0.2375
000_1010	1.4250	010_1010	1.0250	100_1010	0.6250	110_1010	0.2250
000_1011	1.4125	010_1011	1.0125	100_1011	0.6125	110_1011	0.2125
000_1100	1.4000	010_1100	1.0000	100_1100	0.6000	110_1100	0.2000
000_1101	1.3875	010_1101	0.9875	100_1101	0.5875	110_1101	0.1875
000_1110	1.3750	010_1110	0.9750	100_1110	0.5750	110_1110	0.1750
000_1111	1.3625	010_1111	0.9625	100_1111	0.5625	110_1111	0.1625
001_0000	1.3500	011_0000	0.9500	101_0000	0.5500	111_0000	0.1500
001_0001	1.3375	011_0001	0.9375	101_0001	0.5375	111_0001	0.1375
001_0010	1.3250	011_0010	0.9250	101_0010	0.5250	111_0010	0.1250
001_0011	1.3125	011_0011	0.9125	101_0011	0.5125	111_0011	0.1125
001_0100	1.3000	011_0100	0.9000	101_0100	0.5000	111_0100	0.1000
001_0101	1.2875	011_0101	0.8875	101_0101	0.4875	111_0101	0.0875
001_0110	1.2750	011_0110	0.8750	101_0110	0.4750	111_0110	0.0750
001_0111	1.2625	011_0111	0.8625	101_0111	0.4625	111_0111	0.0625
001_1000	1.2500	011_1000	0.8500	101_1000	0.4500	111_1000	0.0500
001_1001	1.2375	011_1001	0.8375	101_1001	0.4375	111_1001	0.0375
001_1010	1.2250	011_1010	0.8250	101_1010	0.4250	111_1010	0.0250
001_1011	1.2125	011_1011	0.8125	101_1011	0.4125	111_1011	0.0125
001_1100	1.2000	011_1100	0.8000	101_1100	0.4000	111_1100	OFF
001_1101	1.1875	011_1101	0.7875	110_1101	0.3875	111_1101	OFF
001_1110	1.1750	011_1110	0.7750	101_1110	0.3750	111_1110	OFF
001_1111	1.1625	011_1111	0.7625	101_1111	0.3625	111_1111	OFF



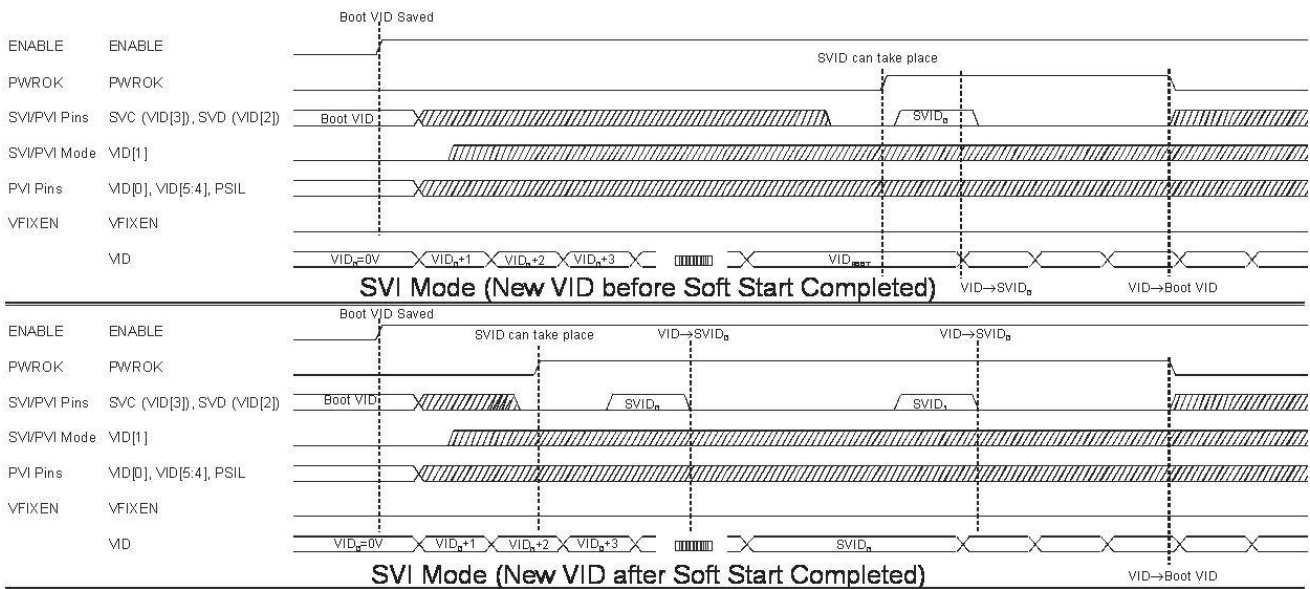

Figure 11. Power Up Sequences Before and After Soft Start in SVI Mode

**Hardware Jumper Override – V\_FIX**

VFIX is an active low pin and when it is pulled low, the controller enters V\_FIX mode. The voltage regulator can be powered when an external SVI bus master is not present. When in VFIX mode, all of the voltage regulator’s output voltages will be governed by the information shown in Table 3, regardless of the state of PWROK. VFIX mode is for debug and bring-up only. If VFIX mode is necessary for processor bring-up, VFIXEN, SVC, and SVD should be connected with jumpers to either ground or VDDIO through suitable pull-up resistors. SVC and SVD are considered as static VID and the output voltage will change according to their status.

**Table 3. SVI VFIX VID CODES (TWO-BIT PARALLEL)**

SVC	SVD	V <sub>OUT</sub> (V)
0	0	1.4
0	1	1.2
1	0	1.0
1	1	0.8

Start-up sequences are presented below:

- Boot VID is captured from SVC and SVD pins on rising edge of ENABLE.

- This capture is *INDEPENDENT* of any other signal. SVI/PVI is determined by sampling VID[1] during rising edge of ENABLE (SVI: VID[1]=0, PVI: VID[1]=1). Once SVI/PVI is determined, the VID controller is enabled and increments to the Boot VID at the Soft Start rate. VFIXEN mode is entered once VFIXEN is asserted.
- If VFIXEN is asserted prior to the VID controller reaching the Boot VID, the VID controller will move to the VFIXEN VID. Once the first VID value is reached (either BOOT VID or VFIXEN VID), the VID will now increment at the Normal rate. Once the VID controller is enabled, the VID controller can receive VFIXEN VIDs, independent of PWROK which is ignored in VFIXEN mode.
- If VFIXEN is de-asserted, the device PORs. This occurs independent of ENABLE

**PWROK De-assertion**

Anytime PWROK de-asserts while EN is asserted, the controller uses the previously stored *BOOT VID* and regulates all planes to that level performing an on-the-Fly transition to that level. PWRGOOD remains asserted in this process.

**Protection Features:**

**Undervoltage Lockout**

An undervoltage lockout (UVLO) senses the VCC and VCCP input. During powerup, the input voltage to the controller is monitored, and the PWM outputs and the soft-start circuit are disabled until the input voltage exceeds the threshold voltage of the UVLO comparator. The UVLO comparator incorporates hysteresis to avoid chattering, since VCC is likely to decrease as soon as the converter initiates soft-start.

**Overcurrent Shutdown**

A programmable overcurrent function is incorporated within the IC. A comparator and latch make up this function. The inverting input of the comparator is connected to the ILIM pin. The voltage at this pin sets the maximum output current the converter can produce. The ROSC pin provides a convenient and accurate reference voltage from which a resistor divider can create the overcurrent setpoint voltage. Although not actually disabled, tying the ILIM pin directly to the ROSC pin sets the limit above useful levels - effectively disabling overcurrent shutdown. The comparator noninverting input is the summed current information from the VDRP minus offset voltage. The overcurrent latch is set when the current information exceeds the voltage at the ILIM pin. The outputs are pulled low, and the soft-start is pulled low. The outputs will remain disabled until the VCC voltage is removed and re-applied, or the ENABLE input is brought low and then high.

**Output Overvoltage and Undervoltage Protection and Power Good Monitor**

An output voltage monitor is incorporated. During normal operation, if the output voltage is 250 mV over the DAC

voltage, the PWRGOOD goes low, the DRVON signal remains high, the PWM outputs are set low. The outputs will remain disabled until the VCC voltage is removed and reapplied. Every time the OV is triggered it will increment the OV counter. If the counter reaches a count of 16 then the OV condition will latch into a permanent OV state. It will require POR or disable/enable to restart. Prior to latching if the OV condition goes away then normal operation will resume. An OV decrement counter is also incorporated. It consists of a free-running clock which runs at 8x the PWM frequency. So essentially every 4096 PWM cycles the OV counter will decrement. For example, for a max PWM frequency of 1 MHz, the counter decrements roughly every 4 ms and for a PWM frequency of 400 kHz, it would be about every 10 ms. During normal operation, if the output voltage falls more than 350\_mV below the DAC setting, the PWRGOOD pin will be set low until the output voltage rises.

**Soft-Start**

The NCP5393 simply ramps V<sub>core</sub> to boot voltage at a fixed rate of 2 ms (0.8 mV/uS), and then reads the VID pins to determine the DAC setting. Then ramps V<sub>core</sub> to the final DAC setting at the Dynamic VID slew rate of up to 3.25 mV/uS. In SVI mode, SoftStart Time is intended as the time required by the device to set the output voltages to the *Pre-PWROK Metal VID*. In PVI mode, VID[0:5] or V\_FIX VID in V\_FIX mode are the set output voltages. Typical soft start sequence timing in SVI mode is given in Figure 12.

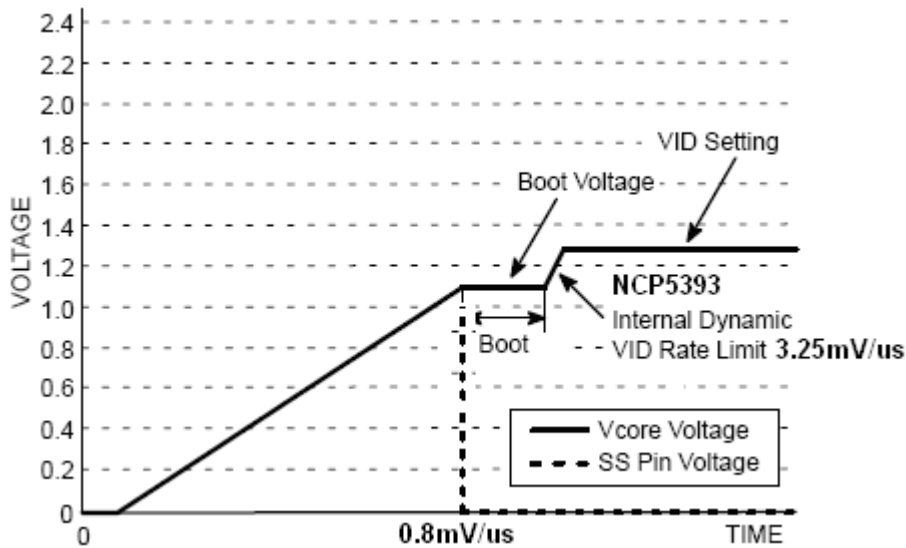

Figure 12. Soft-Start Sequence to V<sub>core</sub> = 1.3 V

**Programming the Current Limit and the Oscillator Frequency**

The demo board is set for an operating frequency of approximately 330 kHz. The ROSC pin provides a 2.0 V reference voltage which is divided down with a resistor divider and fed into the current limit pin ILIM. Calculate the total series resistance to set the frequency and then calculate the individual RLIM1 and RLIM2 values for the divider.

The series resistors RLIM1 and RLIM2 sink current from the ILIM pin to ground. This current is internally mirrored into a capacitor to create an oscillator. The period is

proportional to the resistance and frequency is inversely proportional to the total resistance. The total resistance may be estimated by Equation 2. This equation is valid for the individual phase frequency in both three and four phase mode.

$$R_{TOTAL} \cong 24686 \times F_{sw}^{-1.1549} \tag{eq. 1}$$

$$30.5 \cdot k\Omega \cong 24686 \times 330^{-1.1549}$$

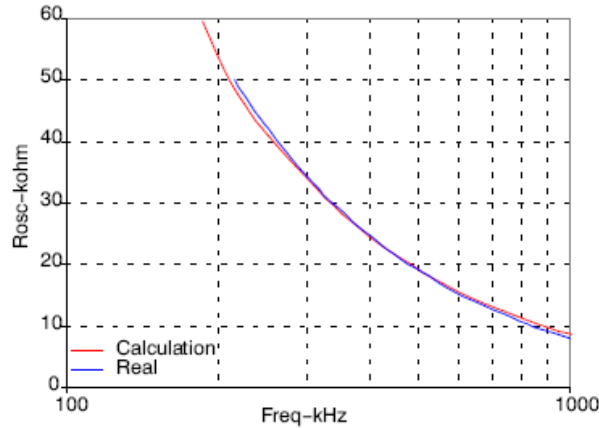

**Figure 13. ROSC vs. Frequency**

The current limit function is based on the total sensed current of all phases multiplied by a gain of 6. DCR sensed inductor current is function of the winding temperature. The best approach is to set the maximum current limit based on Calculate the current limit voltage:

$$V_{LIMIT} \cong 6 \cdot \left( I_{MIN\_OCP} \cdot DCRT_{max} + \frac{DCRT_{max} \cdot V_{out}}{2 \cdot V_{in} \cdot F_{sw}} \cdot \left( \frac{V_{in}-V_{out}}{L} - (N-1) \cdot \frac{V_{out}}{L} \right) \right) \tag{eq. 3}$$

Solve for the individual resistors:

$$RLIM2 = \frac{V_{LIMIT} \cdot R_{TOTAL}}{2 \cdot V} \tag{eq. 4}$$

$$RLIM1 = R_{TOTAL} - RLIM2 \tag{eq. 5}$$

**Final Equation for the Current Limit Threshold**

$$I_{LIMIT}(T_{inductor}) \cong \frac{\left( \frac{2 \cdot V \cdot RLIM2}{RLIM1 + RLIM2} \right)}{6 \cdot (DCR_{25C} \cdot (1 + 0.00393(T_{inductor}-25)))} - \frac{V_{out}}{2 \cdot V_{in} \cdot F_{sw}} \cdot \left( \frac{V_{in}-V_{out}}{L} - (N-1) \cdot \frac{V_{out}}{L} \right) \tag{eq. 6}$$

The inductors on the demo board have a DCR at 25°C of 0.75 mΩ. Selecting the closest available values of 16.9 kΩ for RLIM1 and 13.7 kΩ for RLIM2 yield a nominal operating frequency of 330 kHz and an approximate current

the expected average maximum temperature of the inductor windings.

$$DCRT_{max} = DCR_{25C} \cdot (1 + 0.00393 (T_{max} - 25)) \tag{eq. 2}$$

limit of 152 A at 100°C. The total sensed current can be observed as a scaled voltage at the VDRP pin added to a positive, no-load offset of approximately 1.3 V.

## NCP5393

### OUTPUT OFFSET VOLTAGES

External offset voltages from 0 mV to 800 mV ‘above the DAC’ can be added for the  $V_{DD}$  and  $V_{DD\_NB}$  independently. Offset is set by a resistor divider from  $V_{CC}$  to GND. Output offsets are ratiometric to  $V_{CC}$ . As  $V_{CC}$  changes, the on-chip scaling factors change by the same amount:

$$\text{Offset} = 0.8 \text{ V} \times V_{\text{OFFSET}}/V_{CC}$$

For example: For 0 V offset: pin voltage = GND; For 800 mV offset: pin voltage =  $V_{CC}$

Minimum Voffset_IN (as Vin/Vcc)	Typical Voffset_IN (as Vin/Vcc)	Maximum Voffset_IN (as Vin/Vcc)	Resulting Output Offset	Units
0	0	0.046875	0	mV
0.046875	0.06250	0.078125	25	mV
0.078125	0.09375	0.109375	50	mV
0.109375	0.12500	0.140625	75	mV
0.140625	0.15625	0.171875	100	mV
0.171875	0.18750	0.203125	125	mV
0.203125	0.21875	0.234375	150	mV
0.234375	0.25000	0.265625	175	mV
0.265625	0.28125	0.296875	200	mV
0.296875	0.31250	0.328125	225	mV
0.328125	0.34375	0.359375	250	mV
0.359375	0.37500	0.390625	275	mV
0.390625	0.40625	0.421875	300	mV
0.421875	0.43750	0.453125	325	mV
0.453125	0.46875	0.484375	350	mV
0.484375	0.50000	0.515625	375	mV
0.515625	0.53125	0.546875	400	mV
0.546875	0.56250	0.578125	425	mV
0.578125	0.59375	0.609375	450	mV
0.609375	0.62500	0.640625	475	mV
0.640625	0.65625	0.671875	500	mV
0.671875	0.68750	0.703125	525	mV
0.703125	0.71875	0.734375	550	mV
0.734375	0.75000	0.765625	575	mV
0.765625	0.78125	0.796875	600	mV
0.796875	0.81250	0.828125	625	mV
0.828125	0.84375	0.859375	650	mV
0.859375	0.87500	0.890625	675	mV
0.890625	0.90625	0.921875	700	mV
0.921875	0.93750	0.953125	725	mV
0.953125	0.96875	0.984375	750	mV
0.984375	1.00000	Vcc+0.3V	800	mV

The input to the OFFSET pin for the VDD output is encoded by an internal ADC.  
 The input to the NB\_OFFSET pin for the VDDNB output is encoded by the same ADC.  
 The reference for this ADC is VCC. The ADC's output is ratiometric to VCC.  
 Voffset IN represents the voltage applied to the OFFSET or NB\_OFFSET pin.  
 It is intended that these voltages be derived by a resistive divider from Vcc.  
 The recommended total driving impedance is <10 kilohms.

# NCP5393

## PACKAGE DIMENSIONS

QFN48 7x7, 0.5P  
CASE 485AJ-01  
ISSUE O

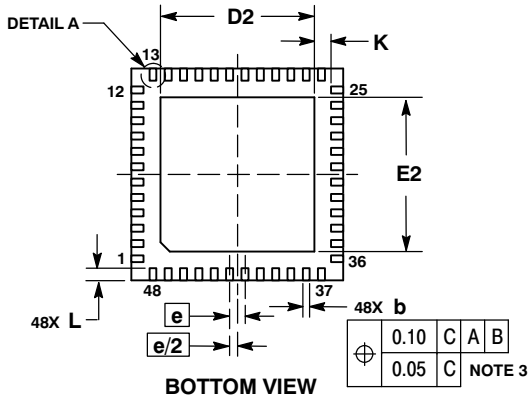
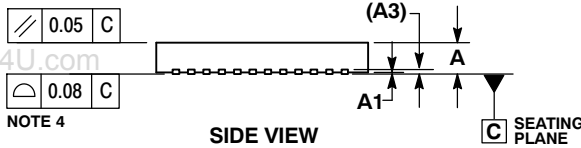
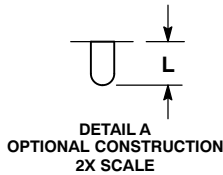
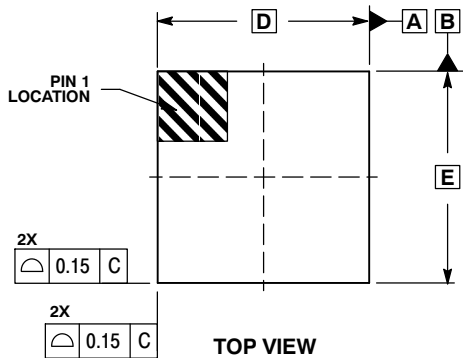

### NOTES:

1. DIMENSIONS AND TOLERANCING PER ASME Y14.5M, 1994.
2. CONTROLLING DIMENSION: MILLIMETERS.
3. DIMENSION b APPLIES TO THE PLATED TERMINAL AND IS MEASURED ABETWEEN 0.15 AND 0.30 MM FROM TERMINAL TIP.
4. COPLANARITY APPLIES TO THE EXPOSED PAD AS WELL AS THE TERMINALS.

DIM	MILLIMETERS	
	MIN	MAX
A	0.80	1.00
A1	0.00	0.05
A3	0.20	REF
b	0.20	0.30
D	7.00	BSC
D2	5.00	5.20
E	7.00	BSC
E2	5.00	5.20
e	0.50	BSC
K	0.20	---
L	0.30	0.50

### SOLDERING FOOTPRINT\*

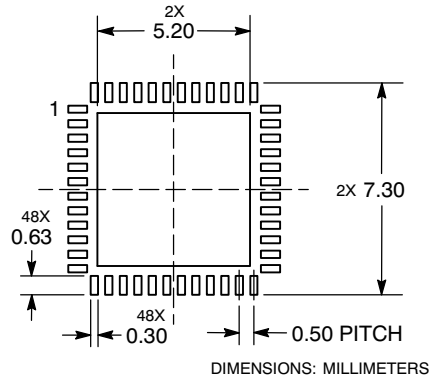

\*For additional information on our Pb-Free strategy and soldering details, please download the ON Semiconductor Soldering and Mounting Techniques Reference Manual, SOLDERRM/D.

The products described herein (NCP5393), may be covered by one or more of the following U.S. patents, #US07057381. There may be other patents pending.

ON Semiconductor and are registered trademarks of Semiconductor Components Industries, LLC (SCILLC). SCILLC reserves the right to make changes without further notice to any products herein. SCILLC makes no warranty, representation or guarantee regarding the suitability of its products for any particular purpose, nor does SCILLC assume any liability arising out of the application or use of any product or circuit, and specifically disclaims any and all liability, including without limitation special, consequential or incidental damages. "Typical" parameters which may be provided in SCILLC data sheets and/or specifications can and do vary in different applications and actual performance may vary over time. All operating parameters, including "Typicals" must be validated for each customer application by customer's technical experts. SCILLC does not convey any license under its patent rights nor the rights of others. SCILLC products are not designed, intended, or authorized for use as components in systems intended for surgical implant into the body, or other applications intended to support or sustain life, or for any other application in which the failure of the SCILLC product could create a situation where personal injury or death may occur. Should Buyer purchase or use SCILLC products for any such unintended or unauthorized application, Buyer shall indemnify and hold SCILLC and its officers, employees, subsidiaries, affiliates, and distributors harmless against all claims, costs, damages, and expenses, and reasonable attorney fees arising out of, directly or indirectly, any claim of personal injury or death associated with such unintended or unauthorized use, even if such claim alleges that SCILLC was negligent regarding the design or manufacture of the part. SCILLC is an Equal Opportunity/Affirmative Action Employer. This literature is subject to all applicable copyright laws and is not for resale in any manner.

### PUBLICATION ORDERING INFORMATION

**LITERATURE FULFILLMENT:**  
Literature Distribution Center for ON Semiconductor  
P.O. Box 5163, Denver, Colorado 80217 USA  
Phone: 303-675-2175 or 800-344-3860 Toll Free USA/Canada  
Fax: 303-675-2176 or 800-344-3867 Toll Free USA/Canada  
Email: orderlit@onsemi.com

**N. American Technical Support:** 800-282-9855 Toll Free  
USA/Canada  
**Europe, Middle East and Africa Technical Support:**  
Phone: 421 33 790 2910  
**Japan Customer Focus Center**  
Phone: 81-3-5773-3850

**ON Semiconductor Website:** [www.onsemi.com](http://www.onsemi.com)  
**Order Literature:** <http://www.onsemi.com/orderlit>  
For additional information, please contact your local Sales Representative