

## 1. General description

---

The TDA9881 is an alignment-free multistandard (PAL and NTSC) vision and sound IF signal PLL demodulator for negative modulation, including Quasi Split Sound (QSS) or intercarrier FM processing.

## 2. Features

---

- 5 V supply voltage
- Gain controlled wideband Vision Intermediate Frequency (VIF) amplifier; AC-coupled
- Multistandard true synchronous demodulation for negative modulated standards with active carrier regeneration: very linear demodulation, good intermodulation figures, reduced harmonics and excellent pulse response
- Fully integrated VIF Voltage Controlled Oscillator (VCO), alignment-free, frequencies switchable via logic pin VIF0 and pin QSSO with resistor
- Digital acquisition help circuit, VIF frequencies of 38.0 MHz, 38.9 MHz, 45.75 MHz and 58.75 MHz
- 4 MHz reference frequency input signal from Phase-Locked Loop (PLL) tuning system or operating as crystal oscillator
- VIF Automatic Gain Control (AGC) detector for gain control; operating as peak sync detector
- VIF AGC monitor output at pin VAGC
- Precise fully digital Automatic Frequency Control (AFC) detector with 4-bit digital-to-analog converter
- TakeOver Point (TOP) adjustable with potentiometer
- Fully integrated sound carrier trap for 4.5 MHz, 5.5 MHz, 6.0 MHz and 6.5 MHz; controlled by FM PLL oscillator
- Sound IF (SIF) input for single reference Quasi Split Sound (QSS) mode; PLL controlled
- SIF AGC for gain controlled SIF amplifier; single reference QSS mixer able to operate in high performance single reference QSS mode or in intercarrier mode; switchable via SIF input pins
- Alignment-free selective FM PLL demodulator with high linearity and low noise.

## 3. Applications

---

- TV, VTR, PC and Set-Top Box (STB) applications.

## 4. Quick reference data

**Table 1: Quick reference data**

Symbol	Parameter	Conditions	Min	Typ	Max	Unit
$V_P$	supply voltage		[1] [2] 4.5	5.0	5.5	V
$I_P$	supply current		52	63	70	mA
<b>Video part</b>						
$V_{i(VIF)(rms)}$	VIF input voltage sensitivity (RMS value)	-1 dB video at output	-	60	100	$\mu$ V
$G_{VIF(cr)}$	VIF gain control range	see <a href="#">Figure 6</a>	60	66	-	dB
$f_{VIF}$	vision carrier operating frequencies	see <a href="#">Table 4</a>	-	38.0	-	MHz
			-	38.9	-	MHz
			-	45.75	-	MHz
			-	58.75	-	MHz
$\Delta f_{VIF}$	VIF frequency window of digital acquisition help	related to $f_{VIF}$ ; see <a href="#">Figure 9</a>	-	$\pm 2.3$	-	MHz
$V_{o(video)(p-p)}$	video signal output voltage (peak-to-peak value)	see <a href="#">Figure 4</a>	1.7	2.0	2.3	V
$G_{dif}$	differential gain	"CCIR 330"; B/G standard	[3] -	-	5	%
$\varphi_{dif}$	differential phase	"CCIR 330"	-	2	4	deg
$B_{video(-3dB)(trap)}$	-3 dB video bandwidth including sound carrier trap	$f_{trap} = 4.5$ MHz	[4] 3.95	4.05	-	MHz
		$f_{trap} = 5.5$ MHz	[4] 4.90	5.00	-	MHz
		$f_{trap} = 6.0$ MHz	[4] 5.40	5.50	-	MHz
		$f_{trap} = 6.5$ MHz	[4] 5.50	5.95	-	MHz
$\alpha_{SC1}$	trap attenuation at first sound carrier	M/N standard	26	36	-	dB
		B/G standard	26	36	-	dB
$S/N_{W(video)}$	weighted signal-to-noise ratio of video signal	weighted in accordance with "CCIR 567"; see <a href="#">Figure 10</a>	[5] 55	-	-	dB
$PSRR_{CVBS}$	power supply ripple rejection at pin CVBS	$f_{ripple} = 70$ Hz; see <a href="#">Figure 5</a>	[6] 20	25	-	dB
$AFC_{stps}$	AFC control steepness	definition: $\Delta I_{AFC}/\Delta f_{VIF}$	0.85	1.05	1.25	$\mu$ A/kHz
<b>Audio part</b>						
$V_{o(AF)(rms)}$	AF output voltage (RMS value)	27 kHz FM deviation; 50 $\mu$ s de-emphasis	430	540	650	mV
THD	total harmonic distortion of audio signal	FM: 27 kHz FM deviation; 50 $\mu$ s de-emphasis	-	0.15	0.50	%
$B_{AF(-3dB)}$	-3 dB AF bandwidth	without de-emphasis; dependent on FM PLL filter	80	100	-	kHz
$S/N_{W(AF)}$	weighted signal-to-noise ratio of audio signal	FM: 27 kHz FM deviation; 50 $\mu$ s de-emphasis; vision carrier unmodulated	52	56	-	dB
$\alpha_{AM(sup)}$	AM suppression of FM demodulator	50 $\mu$ s de-emphasis; AM: $f = 1$ kHz and $m = 54$ %; referenced to 27 kHz FM deviation	40	46	-	dB

Table 1: Quick reference data ...continued

Symbol	Parameter	Conditions	Min	Typ	Max	Unit
PSRR <sub>FMSO</sub>	power supply ripple rejection on pin FMSO	FM: f <sub>ripple</sub> = 70 Hz; see Figure 5	14	20	-	dB
V <sub>o(intc)(rms)</sub>	IF intercarrier output level (RMS value)	QSS mode; SC <sub>1</sub> ; SC <sub>2</sub> off	90	140	210	mV
		intercarrier mode; PC/SC <sub>1</sub> = 20 dB; SC <sub>2</sub> off	[7] -	75	-	mV

Reference frequency

f <sub>ref</sub>	reference signal frequency		[8] -	4	-	MHz
V <sub>ref(rms)</sub>	reference signal voltage (RMS value)	operation as input terminal	80	-	400	mV

- [1] Values of video and sound parameters can be decreased at V<sub>P</sub> = 4.5 V.
- [2] The time constant (R × C) at the supply must be > 1.2 μs (e.g. 1 Ω and 2.2 μF).
- [3] Condition: luminance range (5 steps) from 0 % to 100 %.
- [4] AC load: C<sub>L</sub> < 20 pF and R<sub>L</sub> > 1 kΩ. The sound carrier frequencies (depending on the TV standard) are attenuated by the integrated sound carrier traps (see Figure 12 to Figure 17; |H(s)| is the absolute value of the transfer function).
- [5] S/N<sub>W(video)</sub> is the ratio of the black-to-white amplitude to the black level noise voltage (RMS value measured on pin CVBS). B = 5 MHz (B/G, I and D/K standard). Noise analyzer setting: 200 kHz high-pass and SC-trap switched on.
- [6] Conditions: video signal, grey level and negative modulation.
- [7] The intercarrier output signal at pin QSSO can be calculated by the following formula taking into account the internal video signal with 1.1 V (p-p) as a reference:

$$V_{o(intc)} = 1.1 \text{ V (p-p)} \times \frac{1}{2\sqrt{2}} \times 10^{\frac{\frac{V_{i(SC)}(dB) + 6 \text{ dB} \pm 3 \text{ dB}}{V_{i(PC)}}}{20}} \quad (\text{RMS})$$

where:  $\frac{1}{2\sqrt{2}}$  is the correction term for RMS value,  $\frac{V_{i(SC)}(dB)}{V_{i(PC)}}$  is the sound-to-picture carrier ratio at pins VIF1 and VIF2 in dB, 6 dB is the correction term of internal circuitry and ± 3 dB is the tolerance of video output and intercarrier output V<sub>o(intc)(rms)</sub>.

- [8] Pin REF is able to operate as a 1-pin crystal oscillator input as well as an external reference signal input, e.g. from the tuning system.

## 5. Ordering information

Table 2: Ordering information

Type number	Package		Version
	Name	Description	
TDA9881TS	SSOP24	plastic shrink small outline package; 24 leads; body width 5.3 mm	SOT340-1
TDA9881HN	HVQFN32	plastic thermal enhanced very thin quad flat package; no leads; 32 terminals; body 5 × 5 × 0.85 mm	SOT617-3

## 6. Block diagram

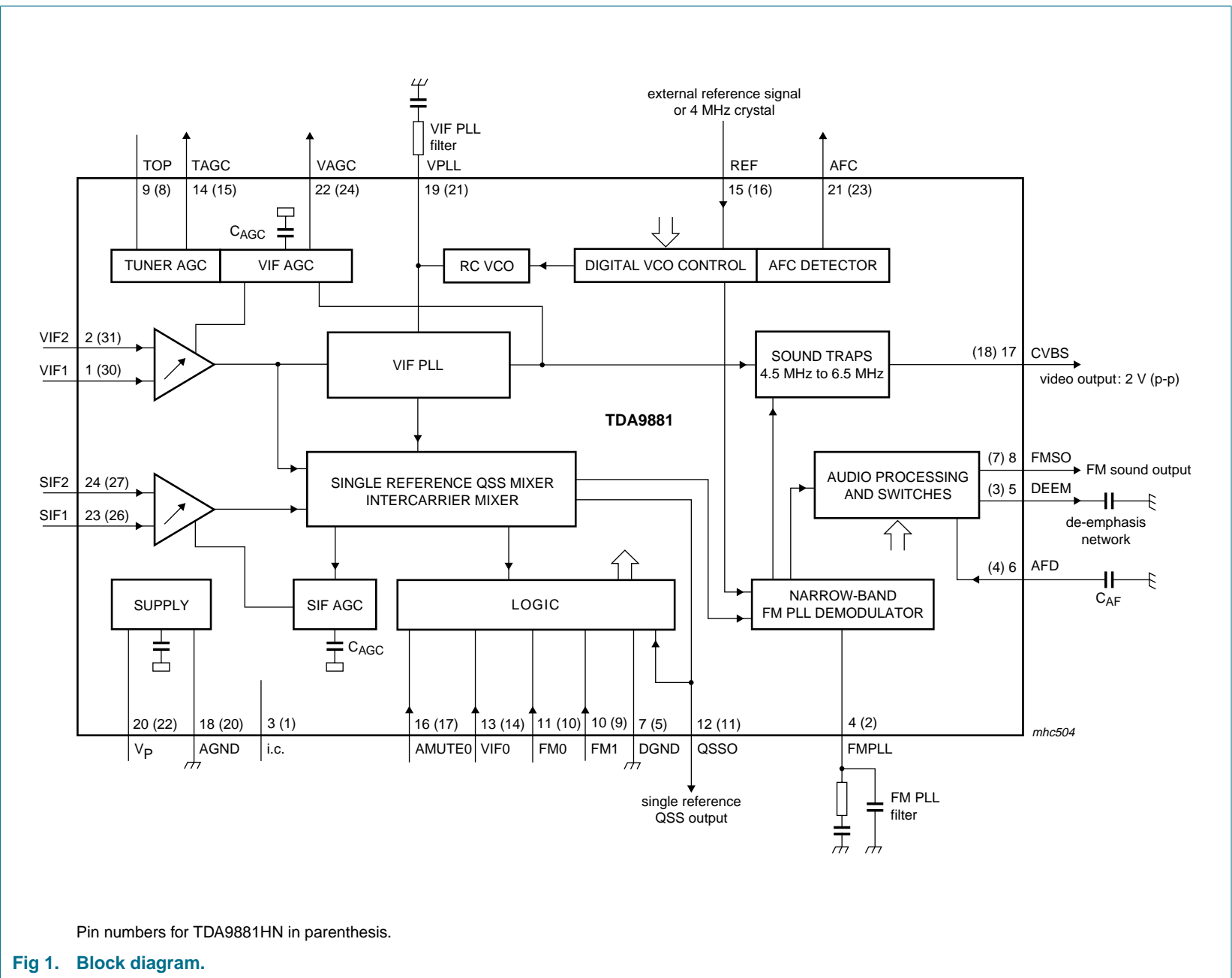

Pin numbers for TDA9881HN in parenthesis.

Fig 1. Block diagram.

## 7. Pinning information

### 7.1 Pinning

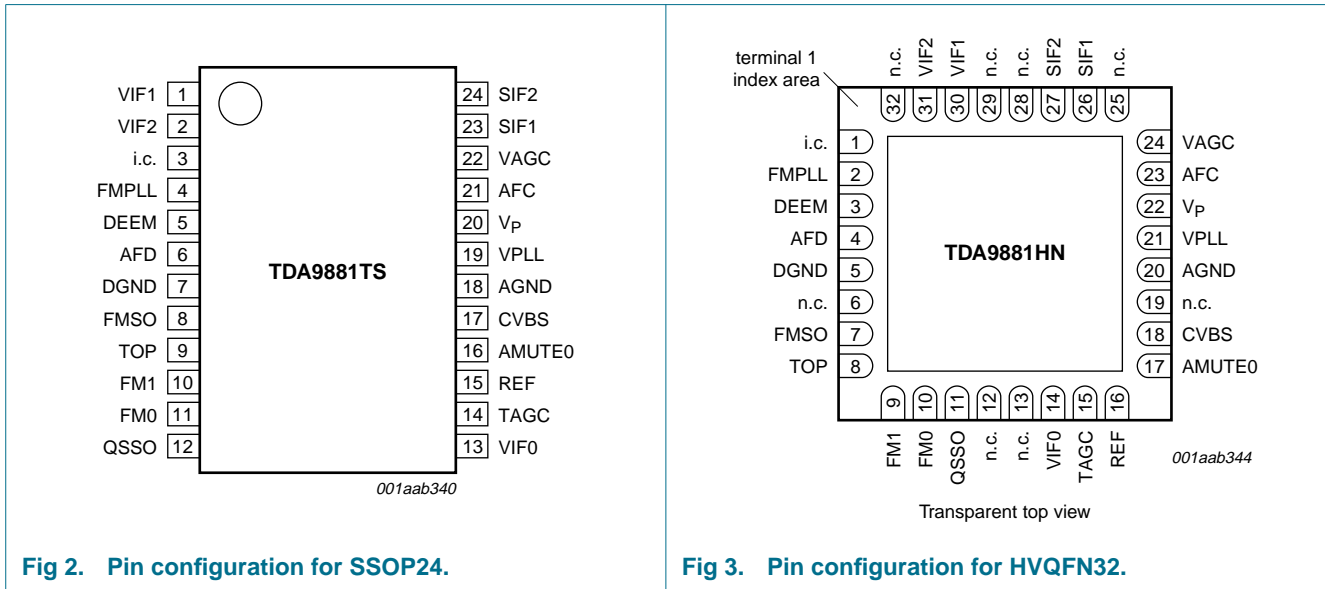

Fig 2. Pin configuration for SSOP24.

Fig 3. Pin configuration for HVQFN32.

## 7.2 Pin description

Table 3: Pin description

Symbol	Pin		Description
	TDA9881TS	TDA9881HN	
VIF1	1	30	VIF differential input 1
VIF2	2	31	VIF differential input 2
n.c.	-	32	not connected
i.c.	3	1	internally connected; leave open
FMPLL	4	2	FM PLL for loop filter
DEEM	5	3	de-emphasis output for capacitor
AFD	6	4	AF decoupling input for capacitor
DGND	7	5	digital ground
n.c.	-	6	not connected
FMSO	8	7	FM sound output
TOP	9	8	tuner AGC TakeOver Point (TOP) for resistor adjustment
FM1	10	9	FM IF select bit 1
FM0	11	10	FM IF select bit 0
QSSO	12	11	single reference QSS output and vision IF select bit 1 with resistor
n.c.	-	12	not connected
n.c.	-	13	not connected
VIF0	13	14	vision IF select bit 0
TAGC	14	15	tuner AGC output
REF	15	16	4 MHz crystal or reference signal input
AMUTE0	16	17	auto mute select bit 0
CVBS	17	18	composite video output
n.c.	-	19	not connected
AGND	18	20	analog ground
VPLL	19	21	VIF PLL for loop filter
V <sub>P</sub>	20	22	supply voltage
AFC	21	23	AFC output
VAGC	22	24	vision AGC output
n.c.	-	25	not connected
SIF1	23	26	SIF differential input 1 and intercarrier mode select
SIF2	24	27	SIF differential input 2 and intercarrier mode select
n.c.	-	28	not connected
n.c.	-	29	not connected

## 8. Functional description

A simplified block diagram of the device is illustrated in [Figure 1](#). The device contains the following functional blocks:

1. VIF amplifier
2. Tuner AGC and VIF AGC
3. VIF AGC detector
4. Frequency Phase-Locked Loop (FPLL) detector
5. VCO and divider
6. AFC and digital acquisition help circuit
7. Video demodulator and amplifier
8. Sound carrier trap
9. SIF amplifier
10. SIF AGC detector
11. Single reference QSS mixer
12. FM demodulator and acquisition help circuit
13. Audio amplifier and mute time constant
14. Internal voltage stabilizer
15. Logic.

### 8.1 VIF amplifier

The VIF amplifier consists of three AC-coupled differential stages. Gain control is performed by emitter degeneration. The total gain control range is typical 66 dB. The differential input impedance is typical 2 k $\Omega$  in parallel with 3 pF.

### 8.2 Tuner AGC and VIF AGC

This block adapts the voltage, generated at the VIF AGC detector, to the internal signal processing at the VIF amplifier and performs the tuner AGC control current generation. The onset of the tuner AGC control current generation can be set by a potentiometer at pin TOP.

### 8.3 VIF AGC detector

Gain control is performed using sync level detection.

The sync level voltage is stored in an integrated capacitor by means of a fast peak detector. This voltage is compared with a reference voltage (nominal sync level) by a comparator which charges or discharges the integrated AGC capacitor to generate the VIF gain. The time constants for decreasing or increasing the gain are nearly equal and the total AGC reaction time is fast, to cope with 'aeroplane fluttering'.

## 8.4 FPLL detector

The VIF amplifier output signal is fed to a frequency detector and a phase detector via a limiting amplifier to remove the video AM.

During acquisition the frequency detector produces a current that is proportional to the frequency difference between the VIF and the VCO signal. After frequency lock-in the phase detector produces a current that is proportional to the phase difference between the VIF and the VCO signal. The currents from the frequency and phase detector are charged into the loop filter which controls the VIF VCO and locks it to the frequency and phase of the VIF carrier.

## 8.5 VCO and divider

The VCO of the VIF FPLL operates as an integrated low radiation relaxation oscillator at twice the picture carrier frequency. The control voltage, required to tune the VCO to actually double the picture carrier frequency, is generated at the loop filter by the frequency phase detector. The possible frequency range is 50 MHz to 140 MHz (typical value).

The oscillator frequency is divided-by-two to provide two differential square wave signals with exactly 90 degrees phase difference, independent of the frequency, for use in the FPLL detectors, the video demodulator and the single reference QSS or intercarrier mixer.

## 8.6 AFC and digital acquisition help circuit

Each relaxation oscillator of the VIF PLL and FM PLL demodulator has a wide frequency range. To prevent false locking of the PLLs, with respect to the catching range, the digital acquisition help circuit provides an individual control until the frequency of the VCO is within the preselected standard dependent lock-in window of the PLL.

The VIF carrier frequencies 38.0 MHz, 38.9 MHz (M/N, B/G, I and D/K standard) and 45.75 MHz, 58.75 MHz (NTSC standard) can be selected via pin VIF0 and pin QSS0 with resistor; see [Table 4](#).

The FM carrier frequencies can be selected via pin FM0 and pin FM1; see [Table 5](#).

The in-window and out-window control at the FM PLL can additionally be used to mute the audio stage (if auto mute is selected via pin AMUTE0); see [Table 6](#).

The principle working of the digital acquisition help circuit is as follows: The PLL VCO output is connected to a downcounter which has a predefined start value (standard dependent). The VCO frequency clocks the downcounter for a fixed gate time. Thereafter, the downcounter stop value is analyzed. In the event that the stop value is higher (lower) than the expected value range, the VCO frequency will be lower (higher) than the required lock-in window frequency range. A positive (negative) control current is injected into the PLL loop filter which causes the VCO frequency to be increased (decreased) and a new counting cycle starts.

The gate time as well as the control logic of the acquisition help circuit is dependent on the precision of the reference signal at pin REF. Operation as a crystal oscillator is possible as well as connecting this input via a serial capacitor to an external reference frequency e.g. the tuning system oscillator.



The AFC signal is derived from the corresponding downcounter stop value after a counting cycle. The last four bits are latched and the digital-to-analog converted value is given as current at pin AFC.

## 8.7 Video demodulator and amplifier

The video demodulator is realized by a multiplier which is designed for low distortion and large bandwidth. The VIF signal is multiplied with the 'in phase' signal of the VIF PLL VCO.

The demodulator output signal is fed into the video preamplifier via a level shift stage with integrated low-pass filter to achieve carrier harmonics attenuation.

The output signal of the preamplifier is fed to the VIF AGC detector (see [Section 8.3](#)) and in the sound trap mode is also fed internally to the integrated sound carrier trap; see [Section 8.8](#). The differential trap output signal is converted and amplified by the following postamplifier. The video output level at pin CVBS is 2 V (p-p).

Noise clipping is provided.

## 8.8 Sound carrier trap

The sound carrier trap consists of a reference filter, a phase detector and the sound trap itself.

A sound carrier reference signal is fed into the reference low-pass filter and is shifted by nominal 90 degrees. The phase detector compares the original reference signal with the signal shifted by the reference filter and produces a DC voltage by charging or discharging an integrated capacitor with a current proportional to the phase difference between both signals, respectively to the frequency error of the integrated filters. The DC voltage controls the frequency position of the reference filter and the sound trap. Thus the accurate frequency position for the different standards is set by the sound carrier reference signal.

The sound trap itself is constructed of three separate traps to realize sufficient suppression of the first and second sound carrier.

## 8.9 SIF amplifier

The SIF amplifier consists of three AC-coupled differential stages. Gain control is performed by emitter degeneration. The total gain control range is typical 66 dB. The differential input impedance is typical 2 k $\Omega$  in parallel with 3 pF.

## 8.10 SIF AGC detector

SIF gain control is performed by the detection of the SIF voltage at the output of the SIF amplifier so that a constant SIF signal is supplied to the single reference QSS mixer.

For an optimum adaption between the SIF AGC and the VIF AGC characteristics at 13 dB picture-to-sound FM carrier ratio, the internal SIF level is reduced.

The integrated AGC capacitor is charged or discharged for the generation of the required SIF gain via a comparator. An additional circuit (threshold approximately 7 dB) ensures a very fast gain reduction for a large increasing IF amplitude step.

### 8.11 Single reference QSS mixer

With the present system high performance Hi-Fi stereo sound processing can be achieved. For a simplified application without an SIF SAW filter, the single reference QSS mixer can be switched to the intercarrier mode via pins SIF1 and SIF2; see [Table 7](#).

The single reference QSS mixer generates the 2nd FM TV sound intercarrier signal. It is realized by a linear multiplier which multiplies the SIF amplifier output signal and the VIF PLL VCO signal which is locked to the picture carrier. In this way the QSS mixer operates as a quadrature mixer in the intercarrier mode and provides suppression of the low frequency video signals.

The QSS mixer output signal is fed internally via a high-pass and low-pass combination to the FM demodulator as well as via an operational amplifier to the QSS output pin QSSO.

### 8.12 FM demodulator and acquisition help circuit

The narrow-band FM PLL detector consists of:

- Gain controlled FM amplifier and AGC detector
- Narrow-band PLL.

The intercarrier signal from the single reference QSS mixer is fed to the input of an AC-coupled gain controlled amplifier with two stages. The gain controlled output signal is fed to the phase detector of the narrow-band FM PLL (FM demodulator). For good selectivity and robustness against disturbance caused by the video signal, a high linearity of the gain controlled FM amplifier and of the phase detector as well as a constant signal level are required. The gain control is done by means of an 'in phase' demodulator for the FM carrier (from the output of the FM amplifier). The demodulation output is fed into a comparator for charging or discharging the integrated AGC capacitor. This leads to a mean value AGC loop to control the gain of the FM amplifier.

The FM demodulator is realized as a narrow-band PLL with an external loop filter, which provides the necessary selectivity (bandwidth approximately 100 kHz). To achieve good selectivity, a linear phase detector and a constant input level are required. The gain controlled intercarrier signal from the FM amplifier is fed to the phase detector. The phase detector controls, via the loop filter, the integrated low radiation relaxation oscillator. The designed frequency range is from 4 MHz to 7 MHz.

The VCO within the FM PLL is phase-locked to the incoming 2nd SIF signal which is frequency modulated. The VCO control voltage is superimposed by the AF voltage. Therefore, the VCO tracks with the FM of the 2nd SIF signal. Thus, the AF voltage is present at the loop filter and is typically 5 mV (RMS) for 27 kHz FM deviation. This AF signal is fed via a buffer to the audio amplifier.

The correct locking of the PLL is supported by the digital acquisition help circuit; see [Section 8.6](#).

### 8.13 Audio amplifier and mute time constant

The audio amplifier consists of two parts:

- AF preamplifier
- AF output amplifier.

The AF preamplifier used for FM sound is an operational amplifier with internal feedback, high gain and high common mode rejection. The AF voltage from the PLL demodulator is 5 mV (RMS) for a frequency deviation of 27 kHz and is amplified by 30 dB. By using a DC operating point control circuit (with external capacitor  $C_{AF}$ ), the AF preamplifier is decoupled from the PLL DC voltage. The low-pass characteristic of the amplifier reduces the harmonics of the sound intercarrier signal at the AF output terminal.

For FM sound a switchable de-emphasis network (with external capacitor) is implemented between the preamplifier and the output amplifier. The de-emphasis time constant with 50  $\mu$ s or 75  $\mu$ s depends on the FM carrier selection via pins FM0 and FM1; see [Table 5](#).

The AF output amplifier provides the required AF output level by a rail-to-rail output stage. A preceding stage makes use of an input selector for switching between the FM sound and mute state.

Switching to the mute state is controlled automatically, depending on the digital acquisition help circuit should the VCO of the FM PLL not be in the required frequency window. This is done by a time constant: fast for switching to the mute state and slow (typically 40 ms) for switching to the non-mute state.

Auto mute can be disabled via pin AMUTE0; see [Table 6](#).

### 8.14 Internal voltage stabilizer

The band gap circuit internally generates a voltage of approximately 2.4 V, independent of the supply voltage and the temperature. A voltage regulator circuit, connected to this voltage, produces a constant voltage of 3.55 V which is used as an internal reference voltage.

### 8.15 Logic

The logic circuit detects the logic level at the logic ports VIF0, QSSO, FM0, FM1 and AMUTE0 and controls the internal functions; see [Table 4](#) to [Table 6](#). In the event that all logic ports are open-circuit (high-ohmic or CMOS HIGH level) TV standard NTSC with a vision carrier frequency of 45.75 MHz, an FM sound carrier frequency of 4.5 MHz, de-emphasis with 75  $\mu$ s time constant and auto mute on is selected.

**Table 4: VIF frequency selection**

QSSO	VIF0	VIF frequency (MHz)
No resistor at pin	pin open-circuit	45.75
No resistor at pin	pin connected to ground	38.9
2.2 k $\Omega$ resistor to ground at pin	pin open-circuit	58.75
2.2 k $\Omega$ resistor to ground at pin	pin connected to ground	38.0

**Table 5: FM carrier frequency selection and de-emphasis settings**

FM0	FM1	FM carrier frequency (MHz)	De-emphasis ( $\mu$ s)
Pin open-circuit	pin open-circuit	4.5	75
Pin connected to ground	pin open-circuit	5.5	50
Pin open-circuit	pin connected to ground	6.0	50
Pin connected to ground	pin connected to ground	6.5	50

**Table 6: Auto mute on/off selection**

AMUTE0	Auto mute
Pin open-circuit	on
Pin connected to ground	off

**Table 7: Sound carrier mode**

SIF1 and SIF2	Sound mode
No DC path to ground	QSS mode
One or both pins connected to ground	intercarrier mode

## 9. Limiting values

**Table 8: Limiting values**

*In accordance with the Absolute Maximum Rating System (IEC 60134).*

Symbol	Parameter	Conditions	Min	Max	Unit
$V_P$	supply voltage		-	5.5	V
$V_n$	voltage on				
	all pins except AGND, DGND and TAGC		0	$V_P$	V
	pin TAGC		0	8.8	V
$t_{sc}$	short-circuit time to ground or $V_P$		-	10	s
$T_{stg}$	storage temperature		-25	+150	$^{\circ}$ C
$T_{amb}$	ambient temperature				
	TDA9881TS (SSOP24)		-20	+70	$^{\circ}$ C
	TDA9881HN (HVQFN32)		-20	+85	$^{\circ}$ C
$V_{esd}$	electrostatic discharge voltage	human body model	[1] -	$\pm$ 4000	V
		machine model	[2] -	$\pm$ 400	V

[1] Class 3A according to JESD22-A114-B.

[2] Class C according to EIA/JESD22-A115-A.

## 10. Thermal characteristics

**Table 9: Thermal characteristics**

Symbol	Parameter	Conditions	Typ	Unit
$R_{th(j-a)}$	thermal resistance from junction to ambient	in free air		
	TDA9881TS (SSOP24)		105	K/W
	TDA9881HN (HVQFN32)		40	K/W

## 11. Characteristics

**Table 10: Characteristics**

$V_P = 5\text{ V}$ ;  $T_{amb} = 25\text{ °C}$ ; see [Table 12](#) for input frequencies; B/G standard is used for the specification ( $f_{PC} = 38.9\text{ MHz}$ ;  $f_{SC} = 33.4\text{ MHz}$ ;  $PC/SC = 13\text{ dB}$ ;  $f_{mod} = 400\text{ Hz}$ ); input level  $V_{i(VIF)} = 10\text{ mV (RMS)}$  (sync level for B/G); IF input from  $50\text{ }\Omega$  via broadband transformer 1 : 1; video modulation DSB; residual carrier for B/G is 10 %; video signal in accordance with "CCIR line 17 and line 330"; measurements taken in test circuit of [Figure 21](#); unless otherwise specified.

Symbol	Parameter	Conditions	Min	Typ	Max	Unit
<b>Supply; pin <math>V_P</math></b>						
$V_P$	supply voltage		[1] 4.5	5.0	5.5	V
$I_P$	supply current		52	63	70	mA
$P_{tot}$	total power dissipation		-	305	385	mW
<b>Power-on reset</b>						
$V_{P(start)}$	supply voltage for start of reset	decreasing supply voltage	2.5	3.0	3.5	V
$V_{P(stop)}$	supply voltage for end of reset	increasing supply voltage	-	-	4.4	V
$\tau_P$	time constant ( $R \times C$ ) for network at pin $V_P$		1.2	-	-	$\mu\text{s}$
<b>VIF amplifier; pins VIF1 and VIF2</b>						
$V_{i(VIF)(rms)}$	VIF input voltage sensitivity (RMS value)	-1 dB video at output	-	60	100	$\mu\text{V}$
$V_{i(max)(rms)}$	maximum input voltage (RMS value)	+1 dB video at output	150	190	-	mV
$V_{i(ovl)(rms)}$	overload input voltage (RMS value)		[2] -	-	440	mV
$\Delta V_{IF(int)}$	internal IF amplitude difference between picture and sound carrier	within AGC range; $\Delta f = 5.5\text{ MHz}$	-	0.9	-	dB
$G_{VIF(cr)}$	VIF gain control range	see <a href="#">Figure 6</a>	60	66	-	dB
$B_{VIF(-3dB)(ll)}$	lower limit -3 dB VIF bandwidth		-	15	-	MHz
$B_{VIF(-3dB)(ul)}$	upper limit -3 dB VIF bandwidth		-	80	-	MHz
$R_{i(dif)}$	differential input resistance		[3] -	2	-	$\text{k}\Omega$
$C_{i(dif)}$	differential input capacitance		[3] -	3	-	pF
$V_I$	DC input voltage		-	1.93	-	V

**Table 10: Characteristics ...continued**

$V_P = 5\text{ V}$ ;  $T_{amb} = 25\text{ °C}$ ; see [Table 12](#) for input frequencies; B/G standard is used for the specification ( $f_{PC} = 38.9\text{ MHz}$ ;  $f_{SC} = 33.4\text{ MHz}$ ;  $PC/SC = 13\text{ dB}$ ;  $f_{mod} = 400\text{ Hz}$ ); input level  $V_{i(VIF)} = 10\text{ mV (RMS)}$  (sync level for B/G); IF input from  $50\text{ }\Omega$  via broadband transformer 1 : 1; video modulation DSB; residual carrier for B/G is 10 %; video signal in accordance with "CCIR line 17 and line 330"; measurements taken in test circuit of [Figure 21](#); unless otherwise specified.

Symbol	Parameter	Conditions	Min	Typ	Max	Unit
<b>FPLL and true synchronous video demodulator [4]</b>						
$f_{VCO(max)}$	maximum oscillator frequency for carrier regeneration	$f = 2f_{PC}$	120	140	-	MHz
$f_{VIF}$	vision carrier operating frequencies	see <a href="#">Table 4</a>	-	38.0	-	MHz
			-	38.9	-	MHz
			-	45.75	-	MHz
			-	58.75	-	MHz
$\Delta f_{VIF}$	VIF frequency window of digital acquisition help	related to $f_{VIF}$ ; see <a href="#">Figure 9</a>	-	$\pm 2.3$	-	MHz
$t_{acq}$	acquisition time	BL = 70 kHz	[5] -	-	30	ms
$V_{i(lock)(rms)}$	input voltage sensitivity for PLL to be locked (RMS value)	measured on pins VIF1 and VIF2; maximum IF gain	-	50	100	$\mu\text{V}$
$T_{cy(DAH)}$	cycle time of digital acquisition help		-	64	-	$\mu\text{s}$
$K_{O(VIF)}$	VIF VCO steepness	definition: $\Delta f_{VIF}/\Delta V_{VPLL}$	-	20	-	MHz/V
$K_{D(VIF)}$	VIF phase detector steepness	definition: $\Delta I_{VPLL}/\Delta \phi_{VIF}$	-	23	-	$\mu\text{A/rad}$
<b>Video output 2 V; pin CVBS; sound carrier on</b>						
$V_{o(p-p)}$	video output voltage (peak-to-peak value)	see <a href="#">Figure 4</a>	1.7	2.0	2.3	V
V/S	ratio between video (black-to-white) and sync level		1.90	2.33	3.00	
$V_{sync}$	sync voltage level		1.0	1.2	1.4	V
$V_{clip(u)}$	upper video clipping voltage level		$V_P - 1.1$	$V_P - 1$	-	V
$V_{clip(l)}$	lower video clipping voltage level		-	0.7	0.9	V
$R_o$	output resistance		[3] -	-	30	$\Omega$
$I_{bias(int)}$	internal DC bias current for emitter-follower		1.5	2.0	-	mA
$I_{o(sink)(max)}$	maximum AC and DC output sink current		1	-	-	mA
$I_{o(source)(max)}$	maximum AC and DC output source current		3.9	-	-	mA
$\Delta V_{o(CVBS)}$	deviation of CVBS output voltage	50 dB gain control	-	-	0.5	dB
		30 dB gain control	-	-	0.1	dB
$\Delta V_{o(bl)}$	black level tilt		-	-	2	%
$G_{dif}$	differential gain	"CCIR 330"; B/G standard	[6] -	-	5	%

**Table 10: Characteristics ...continued**

$V_P = 5\text{ V}$ ;  $T_{amb} = 25\text{ °C}$ ; see [Table 12](#) for input frequencies; B/G standard is used for the specification ( $f_{PC} = 38.9\text{ MHz}$ ;  $f_{SC} = 33.4\text{ MHz}$ ;  $PC/SC = 13\text{ dB}$ ;  $f_{mod} = 400\text{ Hz}$ ); input level  $V_{i(VIF)} = 10\text{ mV (RMS)}$  (sync level for B/G); IF input from  $50\text{ }\Omega$  via broadband transformer 1 : 1; video modulation DSB; residual carrier for B/G is 10 %; video signal in accordance with "CCIR line 17 and line 330"; measurements taken in test circuit of [Figure 21](#); unless otherwise specified.

Symbol	Parameter	Conditions	Min	Typ	Max	Unit
$\Phi_{dif}$	differential phase	"CCIR 330"	-	2	4	deg
$S/N_{W(video)}$	weighted signal-to-noise ratio	weighted in accordance with "CCIR 567"; see <a href="#">Figure 10</a>	[7] 55	-	-	dB
$S/N_{UW(video)}$	unweighted signal-to-noise ratio		[7] 47	-	-	dB
$\alpha_{IM(blue)}$	intermodulation attenuation at 'blue'	see <a href="#">Figure 11</a>	[8]			
		$f = 1.1\text{ MHz}$	58	64	-	dB
		$f = 3.3\text{ MHz}$	58	64	-	dB
$\alpha_{IM(yellow)}$	intermodulation attenuation at 'yellow'	see <a href="#">Figure 11</a>	[8]			
		$f = 1.1\text{ MHz}$	60	66	-	dB
		$f = 3.3\text{ MHz}$	59	65	-	dB
$\Delta V_{r(PC)(rms)}$	residual picture carrier (RMS value)	fundamental wave and harmonics	-	2	5	mV
$\alpha_H$	suppression of video signal harmonics	$C_L < 20\text{ pF}$ ; $R_L > 1\text{ k}\Omega$ ; AC load	[9] 35	40	-	dB
$\alpha_{spur}$	suppression of spurious elements		[10] 40	-	-	dB
$PSRR_{CVBS}$	power supply ripple rejection at pin CVBS	$f_{ripple} = 70\text{ Hz}$ ; see <a href="#">Figure 5</a>	[11] 20	25	-	dB
<b>M/N standard inclusive Korea; see <a href="#">Figure 12</a></b>						
$B_{V(-3dB)(trap)}$	-3 dB video bandwidth including sound carrier trap	$f_{trap} = 4.5\text{ MHz}$	[12] 3.95	4.05	-	MHz
$\alpha_{SC1}$	attenuation at first sound carrier	$f = 4.5\text{ MHz}$	26	36	-	dB
$\alpha_{SC1(60kHz)}$	attenuation at first sound carrier $f_{SC1} \pm 60\text{ kHz}$	$f = 4.5\text{ MHz}$	20	27	-	dB
$\alpha_{SC2}$	attenuation at second sound carrier	$f = 4.724\text{ MHz}$	20	27	-	dB
$\alpha_{SC2(60kHz)}$	attenuation at second sound carrier $f_{SC2} \pm 60\text{ kHz}$	$f = 4.724\text{ MHz}$	14	21	-	dB
$t_{d(g)(cc)}$	group delay at color carrier frequency	$f = 3.58\text{ MHz}$ ; see <a href="#">Figure 13</a>	110	180	250	ns
<b>B/G standard; see <a href="#">Figure 14</a></b>						
$B_{V(-3dB)(trap)}$	-3 dB video bandwidth including sound carrier trap	$f_{trap} = 5.5\text{ MHz}$	[12] 4.90	5.00	-	MHz
$\alpha_{SC1}$	attenuation at first sound carrier	$f = 5.5\text{ MHz}$	26	36	-	dB
$\alpha_{SC1(60kHz)}$	attenuation at first sound carrier $f_{SC1} \pm 60\text{ kHz}$	$f = 5.5\text{ MHz}$	20	30	-	dB

**Table 10: Characteristics ...continued**

$V_P = 5\text{ V}$ ;  $T_{amb} = 25\text{ °C}$ ; see [Table 12](#) for input frequencies; B/G standard is used for the specification ( $f_{PC} = 38.9\text{ MHz}$ ;  $f_{SC} = 33.4\text{ MHz}$ ;  $PC/SC = 13\text{ dB}$ ;  $f_{mod} = 400\text{ Hz}$ ); input level  $V_{i(VIF)} = 10\text{ mV (RMS)}$  (sync level for B/G); IF input from  $50\text{ }\Omega$  via broadband transformer 1 : 1; video modulation DSB; residual carrier for B/G is 10 %; video signal in accordance with "CCIR line 17 and line 330"; measurements taken in test circuit of [Figure 21](#); unless otherwise specified.

Symbol	Parameter	Conditions	Min	Typ	Max	Unit
$\alpha_{SC2}$	attenuation at second sound carrier	$f = 5.742\text{ MHz}$	20	27	-	dB
$\alpha_{SC2(60kHz)}$	attenuation at second sound carrier $f_{SC2} \pm 60\text{ kHz}$	$f = 5.742\text{ MHz}$	14	21	-	dB
$t_{d(g)(cc)}$	group delay at color carrier frequency	$f = 4.43\text{ MHz}$ ; see <a href="#">Figure 15</a>	110	180	250	ns
I standard; see <a href="#">Figure 16</a>						
$B_{V(-3dB)(trap)}$	-3 dB video bandwidth including sound carrier trap	$f_{trap} = 6.0\text{ MHz}$	<a href="#">[12]</a> 5.40	5.50	-	MHz
$\alpha_{SC1}$	attenuation at first sound carrier	$f = 6.0\text{ MHz}$	26	32	-	dB
$\alpha_{SC1(60kHz)}$	attenuation at first sound carrier $f_{SC1} \pm 60\text{ kHz}$	$f = 6.0\text{ MHz}$	20	26	-	dB
$\alpha_{SC2}$	attenuation at second sound carrier	$f = 6.55\text{ MHz}$	12	18	-	dB
$\alpha_{SC2(60kHz)}$	attenuation at second sound carrier $f_{SC2} \pm 60\text{ kHz}$	$f = 6.55\text{ MHz}$	10	15	-	dB
$t_{d(g)(cc)}$	group delay at color carrier frequency	$f = 4.43\text{ MHz}$	-	90	160	ns
D/K standard; see <a href="#">Figure 17</a>						
$B_{V(-3dB)(trap)}$	-3 dB video bandwidth including sound carrier trap	$f_{trap} = 6.5\text{ MHz}$	<a href="#">[12]</a> 5.50	5.95	-	MHz
$\alpha_{SC1}$	attenuation at first sound carrier	$f = 6.5\text{ MHz}$	26	32	-	dB
$\alpha_{SC1(60kHz)}$	attenuation at first sound carrier $f_{SC1} \pm 60\text{ kHz}$	$f = 6.5\text{ MHz}$	20	26	-	dB
$\alpha_{SC2}$	attenuation at second sound carrier	$f = 6.742\text{ MHz}$	18	24	-	dB
$\alpha_{SC2(60kHz)}$	attenuation at second sound carrier $f_{SC2} \pm 60\text{ kHz}$	$f = 6.742\text{ MHz}$	13	18	-	dB
$t_{d(g)(cc)}$	group delay at color carrier frequency	$f = 4.28\text{ MHz}$	-	60	130	ns
<b>VIF AGC</b>						
$t_{resp(inc)}$	AGC response time to an increasing VIF step	20 dB	<a href="#">[13]</a> -	4	-	ms
$t_{resp(dec)}$	AGC response time to a decreasing VIF step	20 dB	<a href="#">[13]</a> -	3	-	ms



**Table 10: Characteristics ...continued**

$V_P = 5\text{ V}$ ;  $T_{amb} = 25\text{ °C}$ ; see [Table 12](#) for input frequencies; B/G standard is used for the specification ( $f_{PC} = 38.9\text{ MHz}$ ;  $f_{SC} = 33.4\text{ MHz}$ ;  $PC/SC = 13\text{ dB}$ ;  $f_{mod} = 400\text{ Hz}$ ); input level  $V_{i(VIF)} = 10\text{ mV (RMS)}$  (sync level for B/G); IF input from  $50\text{ }\Omega$  via broadband transformer 1 : 1; video modulation DSB; residual carrier for B/G is 10 %; video signal in accordance with "CCIR line 17 and line 330"; measurements taken in test circuit of [Figure 21](#); unless otherwise specified.

Symbol	Parameter	Conditions	Min	Typ	Max	Unit
$CR_{stps}$	control steepness	definition: $\Delta G_{VIF}/\Delta V_{VAGC}$ ; $V_{VAGC} = 2\text{ V to }3\text{ V}$	-	-80	-	dB/V
<b>Pin VAGC</b>						
$V_{VAGC}$	gain control voltage range	see <a href="#">Figure 6</a>	0.8	-	3.5	V
$I_{o(sink)(max)}$	maximum output sink current		-	-	10	$\mu\text{A}$
$I_{o(source)(max)}$	maximum output source current		-	-	10	$\mu\text{A}$
<b>Tuner AGC; pin TAGC; see <a href="#">Figure 6</a> to <a href="#">Figure 8</a></b>						
$V_{i(VIF)(start1)(rms)}$	VIF input signal voltage for minimum starting point of tuner takeover at pins VIF1 and VIF2 (RMS value)	$I_{TAGC} = 120\text{ }\mu\text{A}$ ; $R_{TOP} = 22\text{ k}\Omega$	-	2	5	mV
$V_{i(VIF)(start2)(rms)}$	VIF input signal voltage for maximum starting point of tuner takeover at pins VIF1 and VIF2 (RMS value)	$I_{TAGC} = 120\text{ }\mu\text{A}$ ; $R_{TOP} = 0\text{ }\Omega$	45	90	-	mV
$QV_{TOP}$	tuner takeover point accuracy	$I_{TAGC} = 120\text{ }\mu\text{A}$ ; $R_{TOP} = 10\text{ k}\Omega$	7	17	43	mV
$\Delta QV_{TOP}/\Delta T$	takeover point variation with temperature	$I_{TAGC} = 120\text{ }\mu\text{A}$	-	0.03	0.07	dB/K
$V_o$	permissible output voltage	from external source	-	-	8.8	V
$V_{sat}$	saturation voltage	$I_{TAGC} = 450\text{ }\mu\text{A}$	-	-	0.5	V
$I_{sink}$	sink current	no tuner gain reduction; $V_{TAGC} = 8.8\text{ V}$	-	-	0.75	$\mu\text{A}$
		maximum tuner gain reduction; $V_{TAGC} = 1\text{ V}$	450	600	750	$\mu\text{A}$
$\Delta G_{IF}$	IF slip by automatic gain control	tuner gain current from 20 % to 80 %	3	5	8	dB
<b>AFC circuit; pin AFC; see <a href="#">Figure 9</a> [14] [15]</b>						
$AFC_{stps}$	AFC control steepness	definition: $\Delta I_{AFC}/\Delta f_{VIF}$	0.85	1.05	1.25	$\mu\text{A}/\text{kHz}$
$Qf_{VIF(a)}$	analog accuracy of AFC circuit	$I_{AFC} = 0\text{ A}$ ; $f_{REF} = 4\text{ MHz}$	-20	-	+20	kHz
$V_{sat(ul)}$	upper limit saturation voltage		$V_P - 0.6$	$V_P - 0.3$	-	V
$V_{sat(ll)}$	lower limit saturation voltage		-	0.3	0.6	V
$I_{o(source)}$	output source current		160	200	240	$\mu\text{A}$
$I_{o(sink)}$	output sink current		160	200	240	$\mu\text{A}$

**Table 10: Characteristics ...continued**

$V_P = 5\text{ V}$ ;  $T_{amb} = 25\text{ °C}$ ; see [Table 12](#) for input frequencies; B/G standard is used for the specification ( $f_{PC} = 38.9\text{ MHz}$ ;  $f_{SC} = 33.4\text{ MHz}$ ;  $PC/SC = 13\text{ dB}$ ;  $f_{mod} = 400\text{ Hz}$ ); input level  $V_{i(VIF)} = 10\text{ mV (RMS)}$  (sync level for B/G); IF input from  $50\text{ }\Omega$  via broadband transformer 1 : 1; video modulation DSB; residual carrier for B/G is 10 %; video signal in accordance with "CCIR line 17 and line 330"; measurements taken in test circuit of [Figure 21](#); unless otherwise specified.

Symbol	Parameter	Conditions	Min	Typ	Max	Unit
<b>SIF amplifier; pins SIF1 and SIF2</b>						
$V_{i(SIF)(rms)}$	SIF input voltage sensitivity (RMS value)	-3 dB at intercarrier output pin QSSO	-	30	70	$\mu\text{V}$
$V_{i(max)(rms)}$	maximum input voltage (RMS value)	1 dB at intercarrier output pin QSSO	50	70	-	mV
$V_{i(ovl)(rms)}$	overload input voltage (RMS value)		[2] -	-	320	mV
$G_{SIF(cr)}$	SIF gain control range	see <a href="#">Figure 8</a>	60	66	-	dB
$B_{SIF(-3dB)(ll)}$	lower limit -3 dB SIF bandwidth		-	15	-	MHz
$B_{SIF(-3dB)(ul)}$	upper limit -3 dB SIF bandwidth		-	80	-	MHz
$R_{i(dif)}$	differential input resistance		[3] -	2	-	$\text{k}\Omega$
$C_{i(dif)}$	differential input capacitance		[3] -	3	-	pF
$V_I$	DC input voltage		-	1.93	-	V
<b>SIF AGC detector</b>						
$t_{resp}$	AGC response time to an increasing or decreasing SIF step of 20 dB	increasing	-	8	-	ms
		decreasing	-	25	-	ms
<b>Single reference QSS intercarrier mixer; pin QSSO</b>						
$V_{o(intc)(rms)}$	IF intercarrier output level (RMS value)	QSS mode; SC <sub>1</sub> ; SC <sub>2</sub> off	90	140	210	mV
		intercarrier mode; PC/SC <sub>1</sub> = 20 dB; SC <sub>2</sub> off	[16] -	75	-	mV
$B_{intc(-3dB)(ul)}$	upper limit -3 dB intercarrier bandwidth		12	15	-	MHz
$\Delta V_{r(SC)(rms)}$	residual sound carrier (RMS value)	fundamental wave and harmonics	-	2	5	mV
$\Delta V_{r(PC)(rms)}$	residual picture carrier (RMS value)	fundamental wave and harmonics	-	2	5	mV
$R_o$	output resistance		[3] -	-	30	$\Omega$
$V_O$	DC output voltage		-	2	-	V
$I_{bias(int)}$	internal DC bias current for emitter follower		0.9	1.3	-	mA
$I_{o(sink)(max)}$	maximum AC output sink current		0.6	0.8	-	mA
$I_{o(source)(max)}$	maximum AC output source current		0.6	0.8	-	mA
$I_{o(source)}$	DC output source current	QSSO = 0; see <a href="#">Table 4</a>	[17] 0.75	0.93	1.20	mA

**Table 10: Characteristics ...continued**

$V_P = 5\text{ V}$ ;  $T_{amb} = 25\text{ }^\circ\text{C}$ ; see [Table 12](#) for input frequencies; B/G standard is used for the specification ( $f_{PC} = 38.9\text{ MHz}$ ;  $f_{SC} = 33.4\text{ MHz}$ ;  $PC/SC = 13\text{ dB}$ ;  $f_{mod} = 400\text{ Hz}$ ); input level  $V_{i(VIF)} = 10\text{ mV (RMS)}$  (sync level for B/G); IF input from  $50\text{ }\Omega$  via broadband transformer 1 : 1; video modulation DSB; residual carrier for B/G is 10 %; video signal in accordance with "CCIR line 17 and line 330"; measurements taken in test circuit of [Figure 21](#); unless otherwise specified.

Symbol	Parameter	Conditions	Min	Typ	Max	Unit
<b>FM PLL demodulator [15] and [18] to [22]</b>						
<b>Sound intercarrier output; pin QSSO</b>						
$V_{FM(rms)}$	IF intercarrier level for gain controlled operation of FM PLL (RMS value)	corresponding PC/SC ratio at input pins VIF1 and VIF2 is 7 dB to 47 dB	3.2	-	320	mV
$V_{FM(lock)(rms)}$	IF intercarrier level for lock-in of PLL (RMS value)		-	-	2	mV
$V_{FM(det)(rms)}$	IF intercarrier level for FM carrier detect (RMS value)		-	-	2.3	mV
$f_{FM}$	sound intercarrier operating FM frequencies	see <a href="#">Table 5</a>	-	4.5	-	MHz
			-	5.5	-	MHz
			-	6.0	-	MHz
			-	6.5	-	MHz
<b>FM sound output; pin FMSO</b>						
$V_{o(AF)(rms)}$	AF output voltage (RMS value)	25 kHz FM deviation; 75 $\mu\text{s}$ de-emphasis	400	500	600	mV
		27 kHz FM deviation; 50 $\mu\text{s}$ de-emphasis	430	540	650	mV
$V_{o(AF)(cl)(rms)}$	AF output clipping level (RMS value)	THD < 1.5 %	1.3	1.4	-	V
$\Delta V_{o(AF)/\Delta T}$	AF output voltage variation with temperature		-	$3 \times 10^{-3}$	$7 \times 10^{-3}$	dB/K
THD	total harmonic distortion		-	0.15	0.50	%
$\Delta f_{AF}$	frequency deviation	THD < 1.5 %	[19] -	-	$\pm 55$	kHz
$B_{AF(-3dB)}$	-3 dB AF bandwidth	without de-emphasis; measured with FM PLL filter of <a href="#">Figure 21</a>	80	100	-	kHz
$S/N_{W(AF)}$	weighted signal-to-noise ratio of audio signal	FM PLL only; 27 kHz FM deviation; 50 $\mu\text{s}$ de-emphasis	52	56	-	dB
		black picture; see <a href="#">Figure 18</a>	50	56	-	dB
$\Delta V_{r(SC)(rms)}$	residual sound carrier (RMS value)	fundamental wave and harmonics; without de-emphasis	-	-	2	mV
$\alpha_{AM(sup)}$	AM suppression of FM demodulator	referenced to 27 kHz FM deviation; 50 $\mu\text{s}$ de-emphasis; AM: $f = 1\text{ kHz}$ ; $m = 54\text{ %}$	40	46	-	dB

**Table 10: Characteristics ...continued**

$V_P = 5\text{ V}$ ;  $T_{amb} = 25\text{ °C}$ ; see [Table 12](#) for input frequencies; B/G standard is used for the specification ( $f_{PC} = 38.9\text{ MHz}$ ;  $f_{SC} = 33.4\text{ MHz}$ ;  $PC/SC = 13\text{ dB}$ ;  $f_{mod} = 400\text{ Hz}$ ); input level  $V_{i(VIF)} = 10\text{ mV (RMS)}$  (sync level for B/G); IF input from  $50\text{ }\Omega$  via broadband transformer 1 : 1; video modulation DSB; residual carrier for B/G is 10 %; video signal in accordance with "CCIR line 17 and line 330"; measurements taken in test circuit of [Figure 21](#); unless otherwise specified.

Symbol	Parameter	Conditions	Min	Typ	Max	Unit
$PSRR_{FM}$	power supply ripple rejection	$f_{ripple} = 70\text{ Hz}$ ; see <a href="#">Figure 5</a>	14	20	-	dB
<b>FM PLL filter; pin FMPLL</b>						
$V_{loop}$	DC loop voltage		1.5	-	3.3	V
$I_{o(source)(PD)(max)}$	maximum phase detector output source current		-	60	-	$\mu\text{A}$
$I_{o(sink)(PD)(max)}$	maximum phase detector output sink current		-	60	-	$\mu\text{A}$
$I_{o(source)(DAH)}$	output source current of digital acquisition help		-	55	-	$\mu\text{A}$
$I_{o(sink)(DAH)}$	output sink current of digital acquisition help		-	55	-	$\mu\text{A}$
$t_{W(DAH)}$	pulse width of digital acquisition help current		-	16	-	$\mu\text{s}$
$T_{cy(DAH)}$	cycle time of digital acquisition help		-	64	-	$\mu\text{s}$
$K_{O(FM)}$	VCO steepness	definition: $\Delta f_{FM}/\Delta V_{FMPLL}$	-	3.3	-	MHz/V
$K_{D(FM)}$	phase detector steepness	definition: $\Delta I_{FMPLL}/\Delta \phi_{FM}$	-	4	-	$\mu\text{A/rad}$
<b>Audio amplifier</b>						
<b>De-emphasis network; pin DEEM</b>						
$R_o$	output resistance	50 $\mu\text{s}$ de-emphasis; see <a href="#">Table 5</a>	4.4	5.0	5.6	$\text{k}\Omega$
		75 $\mu\text{s}$ de-emphasis; see <a href="#">Table 5</a>	6.6	7.5	8.4	$\text{k}\Omega$
$V_{AF(rms)}$	audio signal (RMS value)	$f_{AF} = 400\text{ Hz}$ ; $V_{FM\text{SO}} = 500\text{ mV}$	-	170	-	mV
$V_O$	DC output voltage		-	2.37	-	V
<b>AF decoupling; pin AFD</b>						
$V_{dec}$	DC decoupling voltage	dependent on $f_{FM}$ intercarrier frequency	1.5	-	3.3	V
$I_L$	leakage current	$\Delta V_{O(FM\text{SO})} < \pm 50\text{ mV}$	-	-	$\pm 25$	nA
$I_{ch(max)}$	maximum charge current		1.15	1.50	1.85	$\mu\text{A}$
$I_{dch(max)}$	maximum discharge current		1.15	1.50	1.85	$\mu\text{A}$
<b>FM sound output; pin FM\text{SO}</b>						
$R_o$	output resistance		<a href="#">3</a> -	-	300	$\Omega$
$V_{O(FM\text{SO})}$	DC output voltage		-	2.37	-	V
$R_L$	load resistance	AC-coupled	10	-	-	$\text{k}\Omega$
$R_{L(DC)}$	DC load resistance		100	-	-	$\text{k}\Omega$
$C_L$	load capacitance		-	-	1.5	nF

**Table 10: Characteristics ...continued**

$V_P = 5\text{ V}$ ;  $T_{amb} = 25\text{ °C}$ ; see [Table 12](#) for input frequencies; B/G standard is used for the specification ( $f_{PC} = 38.9\text{ MHz}$ ;  $f_{SC} = 33.4\text{ MHz}$ ;  $PC/SC = 13\text{ dB}$ ;  $f_{mod} = 400\text{ Hz}$ ); input level  $V_{i(VIF)} = 10\text{ mV (RMS)}$  (sync level for B/G); IF input from  $50\text{ }\Omega$  via broadband transformer 1 : 1; video modulation DSB; residual carrier for B/G is 10 %; video signal in accordance with "CCIR line 17 and line 330"; measurements taken in test circuit of [Figure 21](#); unless otherwise specified.

Symbol	Parameter	Conditions	Min	Typ	Max	Unit
$B_{AF(-3dB)(ul)}$	upper limit -3 dB AF bandwidth of audio amplifier		150	-	-	kHz
$B_{AF(-3dB)(ll)}$	lower limit -3 dB AF bandwidth of audio amplifier		<a href="#">[20]</a> -	-	20	Hz
$\alpha_{mute}$	mute attenuation of AF signal	via pin AMUTE0; see <a href="#">Table 6</a>	70	75	-	dB
$\Delta V_{jump}$	DC jump voltage for switching AF output to mute state or vice versa	activated by digital acquisition help; auto mute on; see <a href="#">Table 6</a>	-	$\pm 50$	$\pm 150$	mV

**FM operation** [\[21\]](#) [\[23\]](#)Intercarrier AF performance [\[24\]](#)

$S/N_W$	weighted signal-to-noise ratio	PC/SC ratio is 21 dB to 27 dB at pins VIF1 and VIF2				
		black picture	49	-	-	dB
		white picture	45	-	-	dB
		6 kHz sine wave (black-to-white modulation)	40	-	-	dB
		sound carrier subharmonics; $f = 2.75\text{ MHz} \pm 3\text{ kHz}$	35	-	-	dB

Single reference QSS AF performance [\[25\]](#) [\[26\]](#)

$S/N_{W(SC1)}$	weighted signal-to-noise ratio for $SC_1$	VIF input sound carrier suppression: PC/SC <sub>1</sub> ratio at pins VIF1 and VIF2 > 40 dB				
		black picture	51	-	-	dB
		white picture	48	-	-	dB
		6 kHz sine wave (black-to-white modulation)	42	-	-	dB
		250 kHz square wave (black-to-white modulation)	40	-	-	dB
		sound carrier subharmonics; $f = 2.75\text{ MHz} \pm 3\text{ kHz}$	43	-	-	dB
		sound carrier subharmonics; $f = 2.87\text{ MHz} \pm 3\text{ kHz}$	44	-	-	dB

**Table 10: Characteristics ...continued**

$V_P = 5\text{ V}$ ;  $T_{amb} = 25\text{ °C}$ ; see [Table 12](#) for input frequencies; B/G standard is used for the specification ( $f_{PC} = 38.9\text{ MHz}$ ;  $f_{SC} = 33.4\text{ MHz}$ ;  $PC/SC = 13\text{ dB}$ ;  $f_{mod} = 400\text{ Hz}$ ); input level  $V_{i(VIF)} = 10\text{ mV (RMS)}$  (sync level for B/G); IF input from  $50\text{ }\Omega$  via broadband transformer 1 : 1; video modulation DSB; residual carrier for B/G is 10 %; video signal in accordance with "CCIR line 17 and line 330"; measurements taken in test circuit of [Figure 21](#); unless otherwise specified.

Symbol	Parameter	Conditions	Min	Typ	Max	Unit
$S/N_{W(SC2)}$	weighted signal-to-noise ratio for $SC_2$	VIF input sound carrier suppression: PC/SC <sub>2</sub> ratio at pins VIF1 and VIF2 > 40 dB				
		black picture	46	-	-	dB
		white picture	45	-	-	dB
		6 kHz sine wave (black-to-white modulation)	41	-	-	dB
		250 kHz square wave (black-to-white modulation)	29	-	-	dB
		sound carrier subharmonics; $f = 2.75\text{ MHz} \pm 3\text{ kHz}$	42	-	-	dB
		sound carrier subharmonics; $f = 2.87\text{ MHz} \pm 3\text{ kHz}$	43	-	-	dB

**Reference frequency input; pin REF**

$V_i$	DC input voltage		2.3	2.6	2.9	V
$R_i$	input resistance		[3]	5	-	k $\Omega$
$R_{xtal}$	resonance resistance of crystal	operation as crystal oscillator	-	-	200	$\Omega$
$C_x$	pull-up or pull-down capacitance		[27]	-	-	pF
$f_{ref}$	reference signal frequency		[28]	4	-	MHz
$\Delta f_{ref}$	tolerance of reference signal frequency		[15]	-	$\pm 0.1$	%
$V_{ref(rms)}$	reference signal voltage (RMS value)	operation as input terminal	80	-	400	mV
$R_{o(ref)}$	output resistance of reference signal source		-	-	4.7	k $\Omega$
$C_K$	decoupling capacitance to external reference signal source	operation as input terminal	22	100	-	pF

**Logic; pins FM1, FM0, VIF0 and AMUTE0; see [Table 4](#) to [Table 6](#)**

$V_i$	input voltage	for LOW level	0	-	0.8	V
		for HIGH level	2.5	-	$V_P$	V
$V_{i(open)}$	free-running voltage	pin open-circuit; $I_i < 0.1\text{ }\mu\text{A}$	-	$V_P$	-	V
$R_i$	internal pull-up resistance		37.5	-	62.5	k $\Omega$

[1] Values of video and sound parameters can be decreased at  $V_P = 4.5\text{ V}$ .

- [2] Level headroom for input level jumps during gain control setting.
- [3] This parameter is not tested during the production and is only given as application information for designing the receiver circuit.
- [4] Loop bandwidth BL = 70 kHz (damping factor d = 1.9; calculated with sync level within gain control range). Calculation of the VIF PLL filter can be done by use of the following formula:

$$BL_{-3dB} = \frac{I}{2\pi} K_O K_D R, \text{ valid for } d \geq 1.2$$

$$d = \frac{I}{2} R \sqrt{K_O K_D C},$$

where:

$K_O$  is the VCO steepness  $\left(\frac{\text{rad}}{\text{V}}\right)$  or  $\left(2\pi \frac{\text{Hz}}{\text{V}}\right)$ ;  $K_D$  is the phase detector steepness  $\left(\frac{\mu\text{A}}{\text{rad}}\right)$ ;

R is the loop resistor; C is the loop capacitor;  $BL_{-3dB}$  is the loop bandwidth for -3 dB; d is the damping factor.

- [5]  $V_{i(VIF)} = 10$  mV (RMS);  $\Delta f = 1$  MHz (VCO frequency offset related to picture carrier frequency); white picture video modulation.
- [6] Condition: luminance range (5 steps) from 0 % to 100 %.
- [7]  $S/N_{W(\text{video})}$  is the ratio of black-to-white amplitude to the black level noise voltage (RMS value measured on pin CVBS). B = 5 MHz (B/G, I and D/K standard). Noise analyzer setting: 200 kHz high-pass and SC-trap switched on.
- [8] The intermodulation figures are defined for:

$$a) f = 1.1 \text{ MHz (referenced to black and white signal) as } \alpha_{IM} = 20 \log\left(\frac{V_o \text{ at } 4.4 \text{ MHz}}{V_o \text{ at } 1.1 \text{ MHz}}\right) + 3.6 \text{ dB}$$

$$b) f = 3.3 \text{ MHz (referenced to color carrier) as } \alpha_{IM} = 20 \log\left(\frac{V_o \text{ at } 4.4 \text{ MHz}}{V_o \text{ at } 3.3 \text{ MHz}}\right)$$

- [9] Modulation Vestigial Side-Band (VSB); sound carrier off;  $f_{\text{video}} > 0.5$  MHz. Measurements taken with SAW filter M1963M (sound shelf: 20 dB); loop bandwidth BL = 70 kHz.
- [10] Sound carrier on;  $f_{\text{video}} = 10$  kHz to 10 MHz. Measurements taken with SAW filter M1963M (sound shelf: 20 dB); loop bandwidth BL = 70 kHz.
- [11] Conditions: video signal, grey level and negative modulation.
- [12] AC load;  $C_L < 20$  pF and  $R_L > 1$  k $\Omega$ . The sound carrier frequencies (depending on TV standard) are attenuated by the integrated sound carrier traps (see [Figure 12](#) to [Figure 17](#);  $|H(s)|$  is the absolute value of transfer function).
- [13] The response time is valid for a VIF input level range from 200  $\mu$ V to 70 mV.
- [14] To match the AFC output signal to different tuning systems a current source output is provided. The test circuit is given in [Figure 9](#). The AFC slope (voltage per frequency) can be changed by resistors R1 and R2.
- [15] The tolerance of the reference frequency determines the accuracy of the VIF AFC, FM demodulator center frequency and maximum FM deviation.
- [16] The intercarrier output signal at pin QSSO can be calculated by the following formula taking into account the internal video signal with 1.1 V (p-p) as a reference:

$$V_{o(\text{intc})} = 1.1 \text{ V (p-p)} \times \frac{I}{2\sqrt{2}} \times 10^{\frac{V_{i(SC)}(dB) + 6 \text{ dB} \pm 3 \text{ dB}}{20}} \quad (\text{RMS})$$

where:  $\frac{I}{2\sqrt{2}}$  is the correction term for RMS value,  $\frac{V_{i(SC)}}{V_{i(PC)}}(dB)$  is the sound-to-picture carrier ratio at pins VIF1 and VIF2 in dB, 6 dB is the correction term of internal circuitry and  $\pm 3$  dB is the tolerance of video output and intercarrier output  $V_{o(\text{intc})}(\text{rms})$ .

- [17] To detect a logical 1 at pin QSSO, no DC load at pin QSSO is allowed. QSSO = 0 will be done by the application of a 2.2 k $\Omega$  resistor between pin QSSO and ground.
- [18] SIF input level is 10 mV (RMS); VIF input level is 10 mV (RMS) unmodulated.
- [19] Measured with an FM deviation of 25 kHz and the typical AF output voltage of 500 mV (RMS). For handling a frequency deviation of more than 55 kHz, the AF output signal has to be reduced in order to avoid clipping (THD < 1.5 %) by means of a resistor  $R_x$  with external application at pin AFD (see [Figure 20](#) and [Figure 21](#)).
- [20] The lower limit of the audio bandwidth depends on the value of the capacitor at pin AFD. A value of  $C_{AF} = 470$  nF leads to  $f_{AF(-3dB)} \approx 20$  Hz and  $C_{AF} = 220$  nF leads to  $f_{AF(-3dB)} \approx 40$  Hz.

- [21] For all S/N measurements the used VIF modulator has to meet the following specifications:
- Incidental phase modulation for black-to-white jump less than 0.5 degrees.
  - QSS AF performance, measured with the television demodulator AMF2 (audio output, weighted S/N ratio) better than 60 dB (at deviation 27 kHz) for 6 kHz sine wave black-to-white video modulation.
  - Picture-to-sound carrier ratio PC/SC<sub>1</sub> = 13 dB (transmitter).
- [22] Calculation of the loop filter can be done approximately by use of the following formulae:

$$f_o = \frac{1}{2\pi\sqrt{C_P}} \sqrt{K_O K_D}$$

$$\vartheta = \frac{1}{2R\sqrt{K_O K_D C_P}}$$

$$BL_{-3dB} = f_o (1.55 - \vartheta^2)$$

The formulae are only valid under the following conditions:

$$\vartheta \leq 1 \text{ and } C_S > 5C_P$$

where:  $K_O$  is the VCO steepness  $\left(\frac{\text{rad}}{\text{V}}\right)$  or  $\left(2\pi\frac{\text{Hz}}{\text{V}}\right)$ ;  $K_D$  is the phase detector steepness  $\left(\frac{\mu\text{A}}{\text{rad}}\right)$ ;  $R$  is the loop resistor;  $C_S$  is the series capacitor;  $C_P$  is the parallel capacitor;  $f_o$  is the natural frequency of PLL;  $BL_{-3dB}$  is the loop bandwidth for -3 dB;  $\vartheta$  is the damping factor. For examples, see [Table 11](#).

- [23] The PC/SC ratio is calculated as the addition of TV transmitter PC/SC<sub>1</sub> ratio and SAW filter PC/SC<sub>1</sub> ratio. This PC/SC ratio is necessary to achieve the S/N<sub>W</sub> values as noted. A different PC/SC ratio will change these values.
- [24] Measurements taken with SAW filter G1984 (Siemens) for vision and sound IF (sound shelf: 14 dB). Picture-to-sound carrier ratio of transmitter PC/SC = 13 dB. Input level on pins VIF1 and VIF2 of  $V_{i(\text{SIF})} = 10$  mV (RMS) sync level, 27 kHz FM deviation for sound carrier,  $f_{AF} = 400$  Hz. Measurements in accordance with "CCIR 468". De-emphasis is 50  $\mu\text{s}$ .
- [25] The QSS signal output on pin QSSO is analyzed by a test demodulator TDA9820. The S/N ratio of this device is more than 60 dB, related to a deviation of  $\pm 27$  kHz, in accordance with "CCIR 468".
- [26] Measurements taken with SAW filter G3962 for vision IF (suppressed sound carrier) and K9350 for sound IF (suppressed picture carrier). Input level  $V_{i(\text{SIF})} = 10$  mV (RMS), 27 kHz (54 % FM deviation).
- [27] The value of  $C_x$  determines the accuracy of the resonance frequency of the crystal. It depends on the used type of crystal.
- [28] Pin REF is able to operate as a 1-pin crystal oscillator input as well as an external reference signal input, e.g. from the tuning system.

**Table 11: Examples to the FM PLL filter**

BL <sub>-3dB</sub> (kHz)	C <sub>S</sub> (nF)	C <sub>P</sub> (pF)	R (k $\Omega$ )	$\vartheta$
100	10	390	5.6	0.5
160	10	150	9.1	0.5

**Table 12: Input frequencies and carrier ratios**

Description	Symbol	B/G standard	M/N standard	Unit
VIF carrier	$f_{PC}$	38.9	45.75 or 58.75	MHz
SIF carrier	$f_{SC1}$	33.4	41.25 or 54.25	MHz
	$f_{SC2}$	33.158	-	MHz
Picture-to-sound carrier ratio	SC <sub>1</sub>	13	7	dB
	SC <sub>2</sub>	20	-	dB



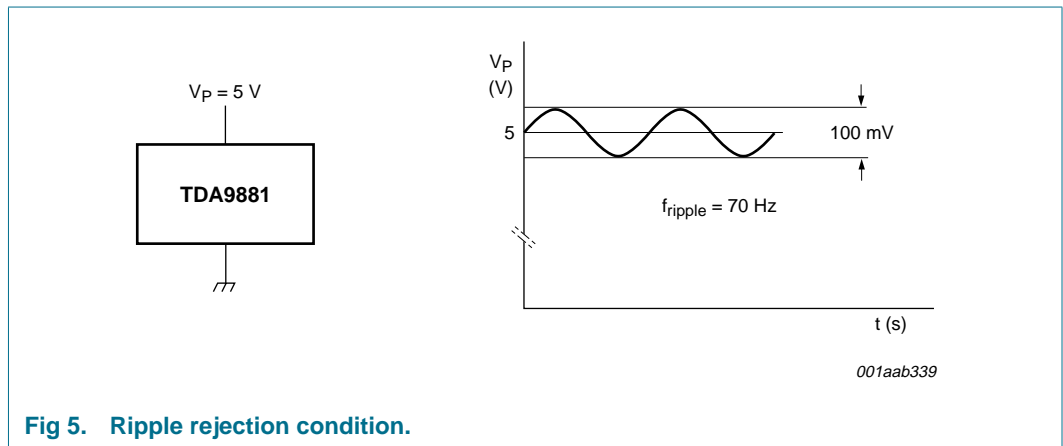
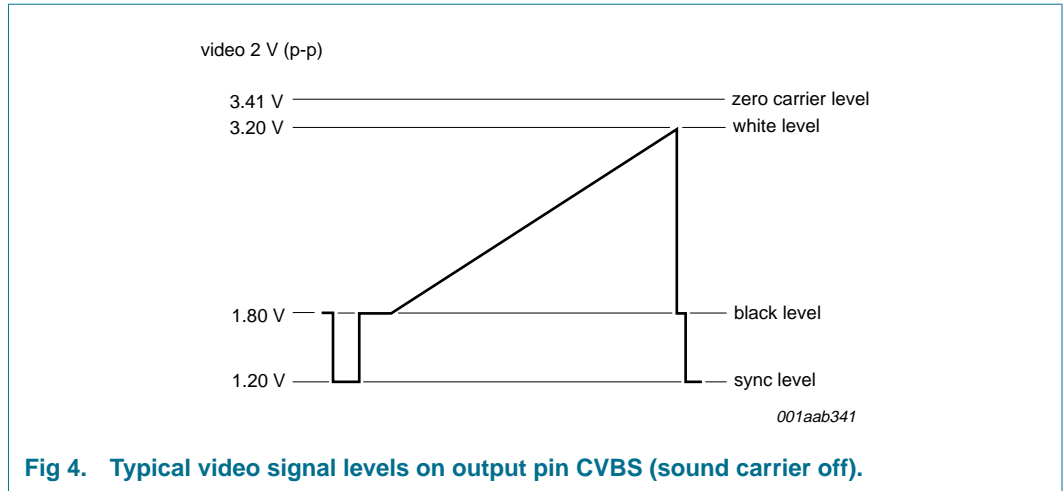

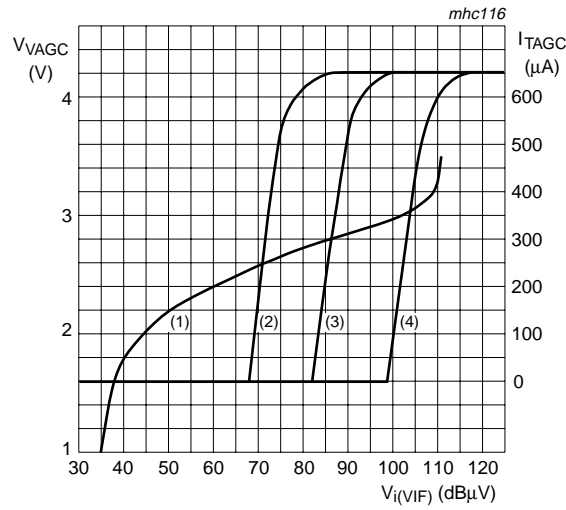

- (1)  $V_{VAGC}$  is VIF AGC voltage and can be measured at pin VAGC.
- (2)  $I_{TAGC}$  is tuner current in TV mode with  $R_{TOP} = 22\text{ k}\Omega$ .
- (3)  $I_{TAGC}$  is tuner current in TV mode with  $R_{TOP} = 10\text{ k}\Omega$ .
- (4)  $I_{TAGC}$  is tuner current in TV mode with  $R_{TOP} = 0\text{ k}\Omega$ .

Fig 6. Typical VIF and tuner AGC characteristics.

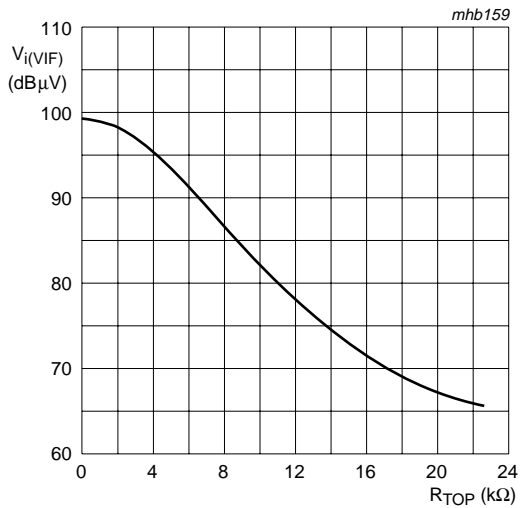

Fig 7. Typical tuner takeover point as a function of resistor  $R_{TOP}$ .

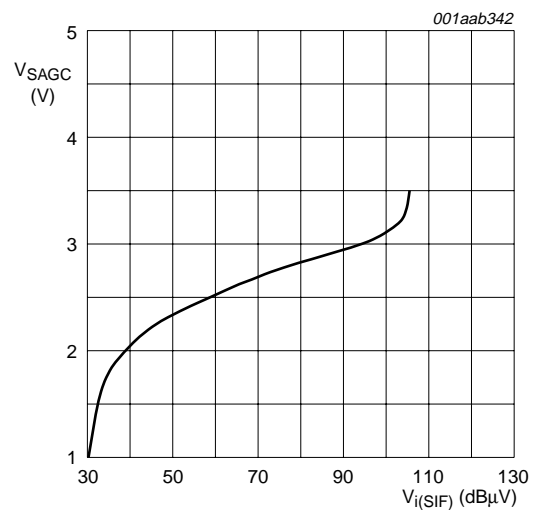
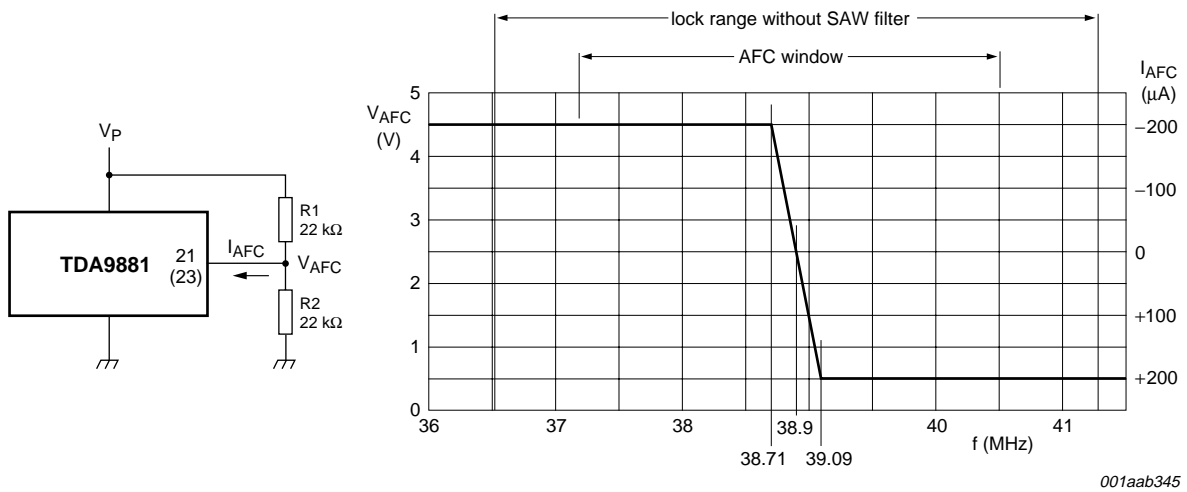

Fig 8. Typical SIF AGC characteristic.



Pin numbers for TDA9881HN in parenthesis.

Fig 9. Typical analog AFC characteristic.

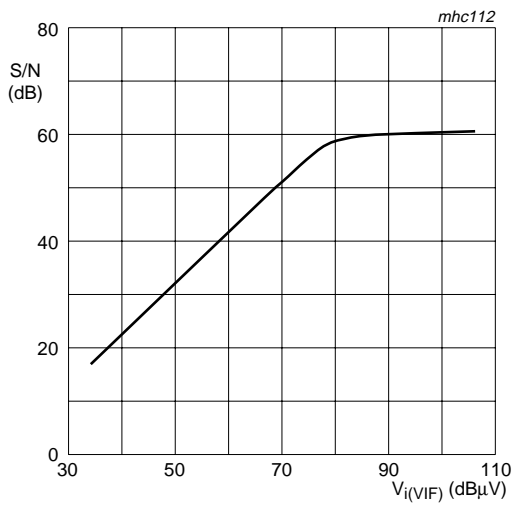
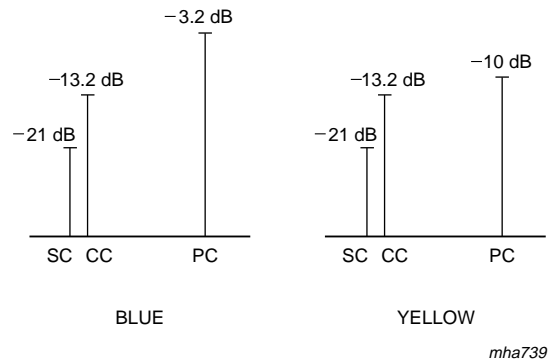

Fig 10. Typical signal-to-noise ratio as a function of VIF input voltage.



SC is sound carrier, with respect to sync level.  
CC is chrominance carrier, with respect to sync level.

PC is picture carrier, with respect to sync level.

The sound carrier levels are taking into account a sound shelf attenuation of 14 dB (SAW filter G1984M).

Fig 11. Input signal conditions.

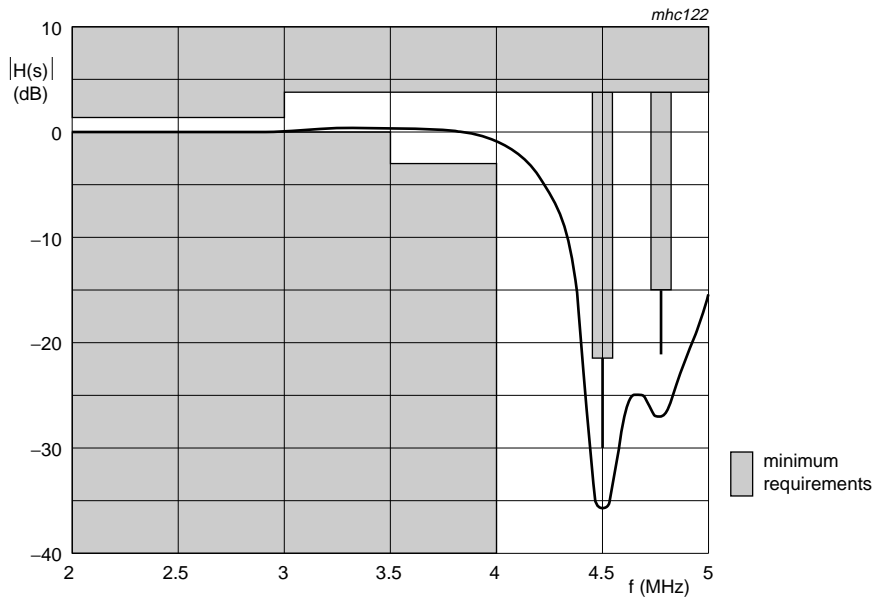
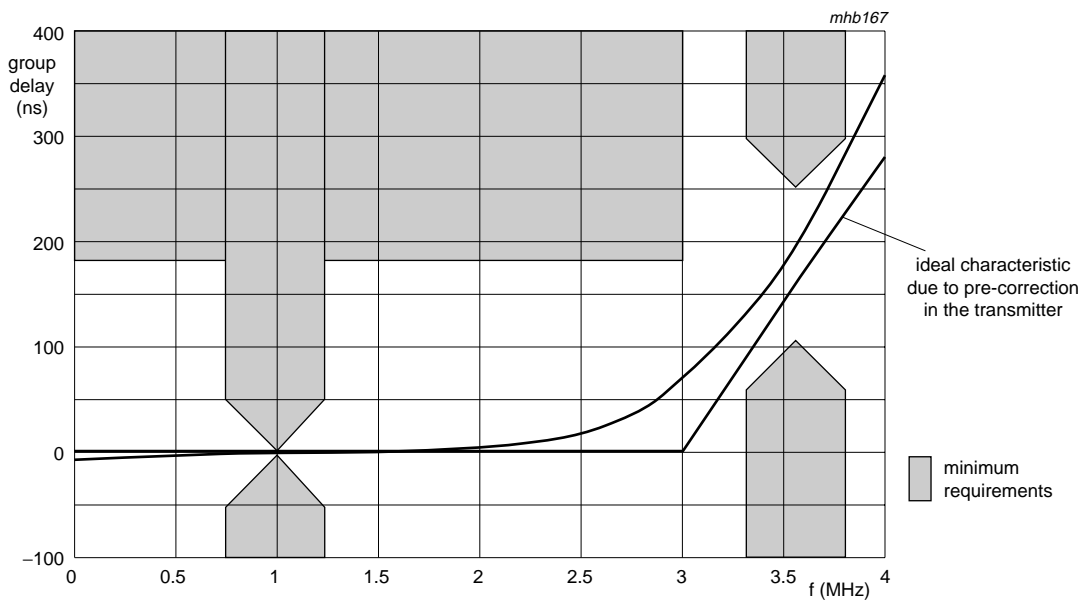

Fig 12. Typical amplitude response for sound trap at M/N standard (inclusive Korea).



Overall delay is not shown, here the maximum ripple is specified.

Fig 13. Typical group delay for sound trap at M/N standard.

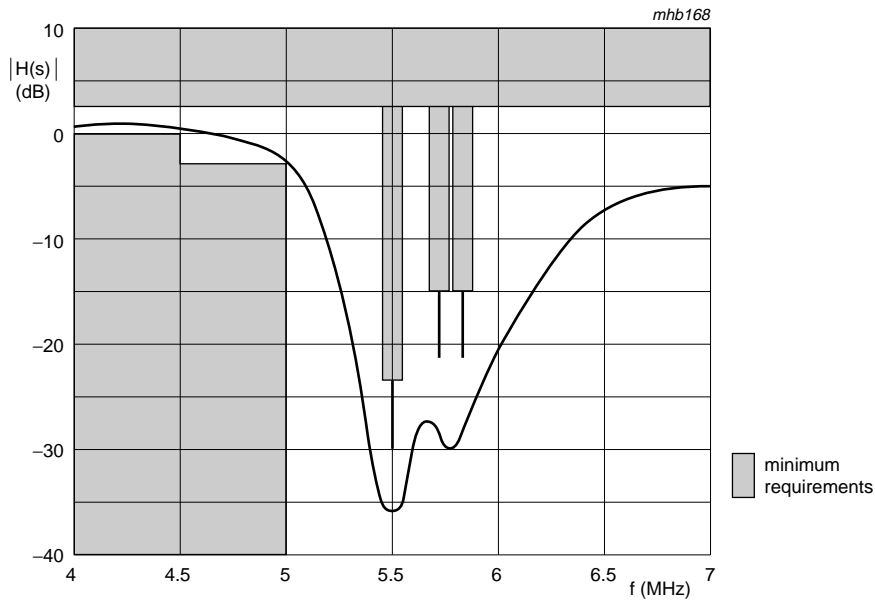
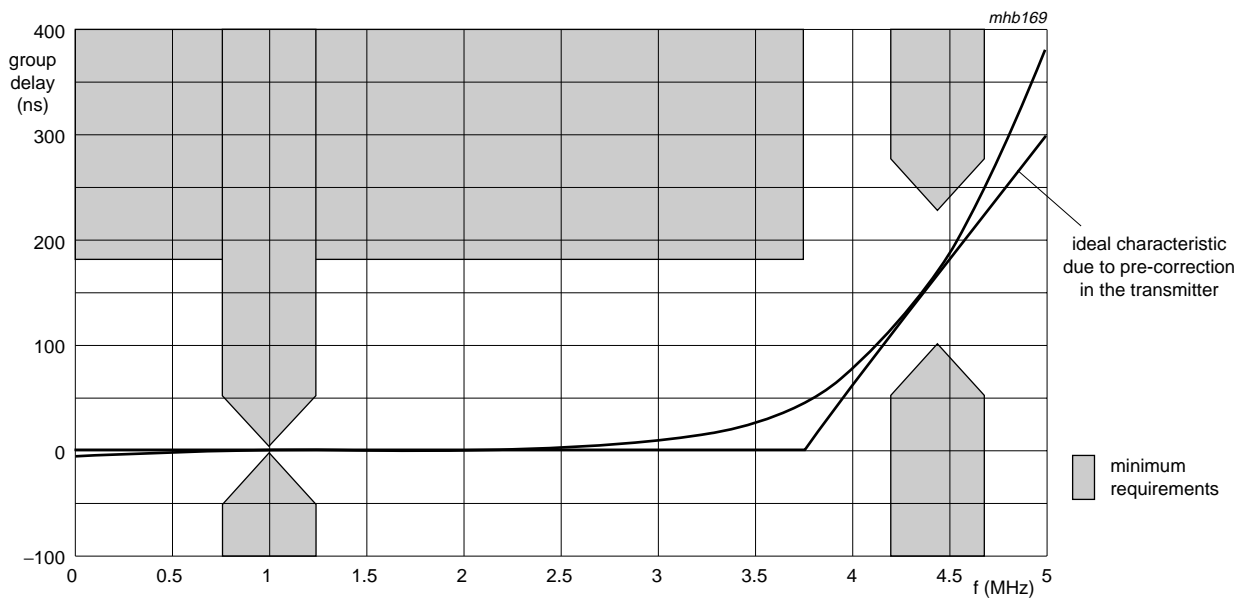

Fig 14. Typical amplitude response for sound trap at B/G standard.



Overall delay is not shown, here the maximum ripple is specified.

Fig 15. Typical group delay for sound trap at B/G standard.

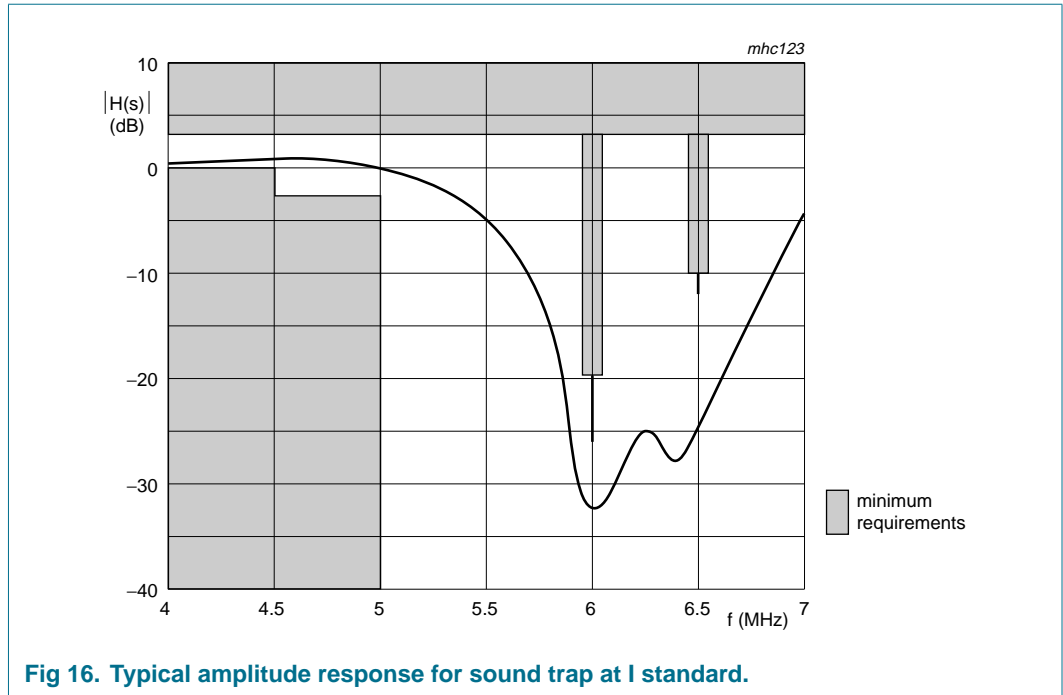

Fig 16. Typical amplitude response for sound trap at I standard.

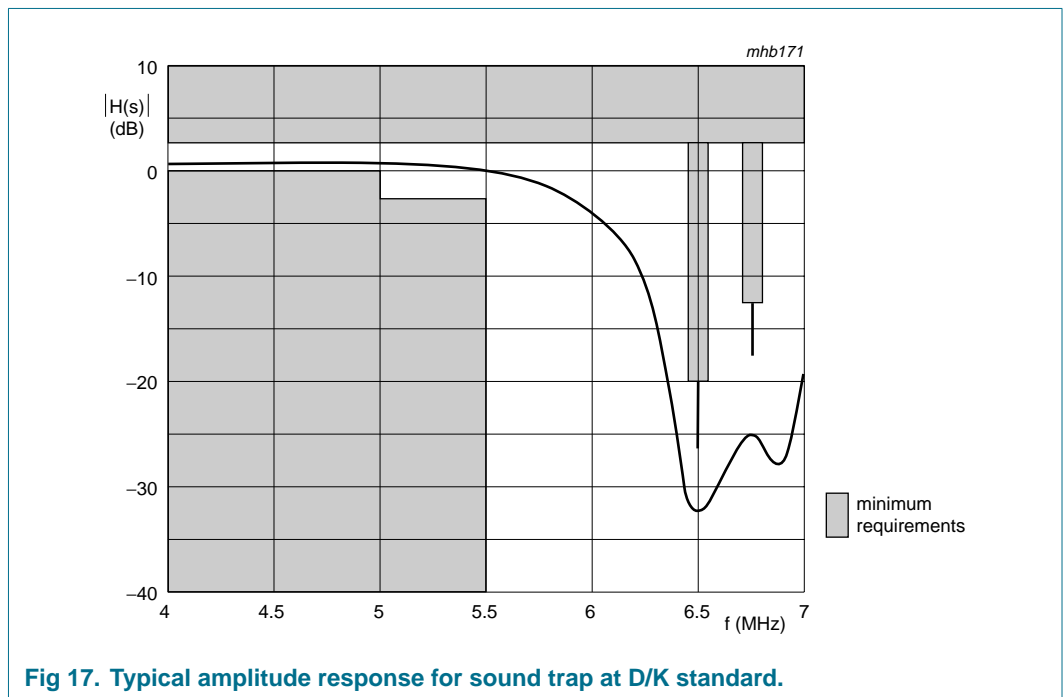
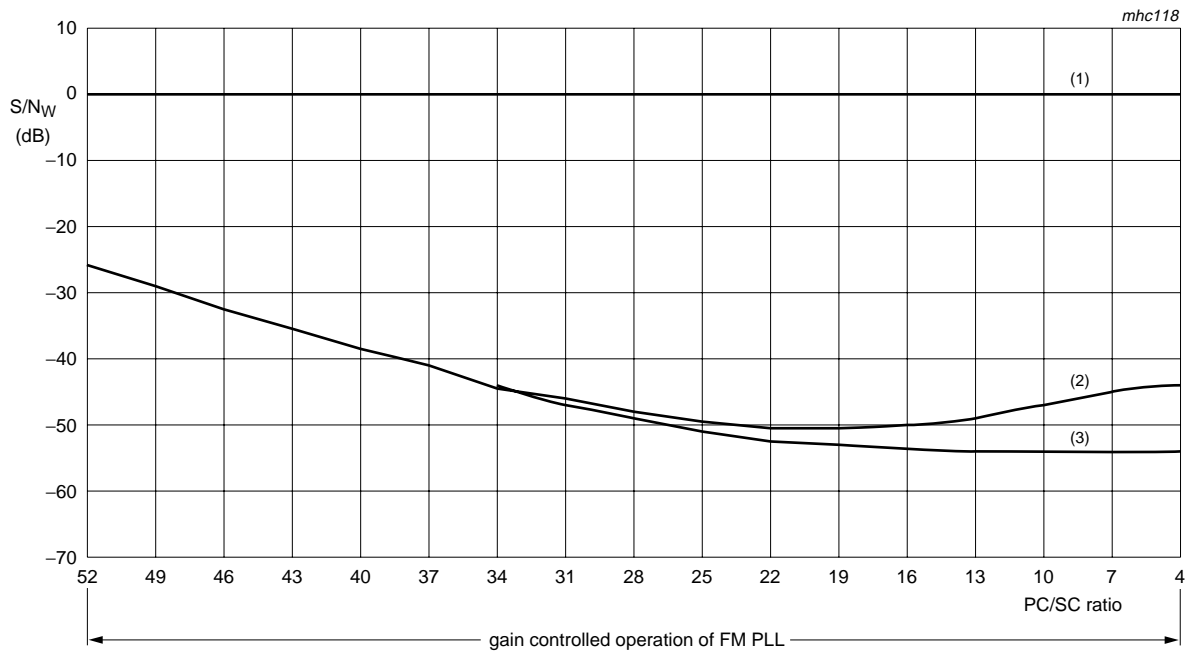

Fig 17. Typical amplitude response for sound trap at D/K standard.



Conditions: PC/SC ratio is measured at pins VIF1 and VIF2; via transformer; 27 kHz FM deviation; 50 μs de-emphasis.

- (1) Signal.
- (2) Noise at H-picture (CCIR weighted quasi peak).
- (3) Noise at black picture (CCIR weighted quasi peak).

**Fig 18. Audio signal-to-noise ratio as a function of picture-to-sound carrier ratio in intercarrier mode.**

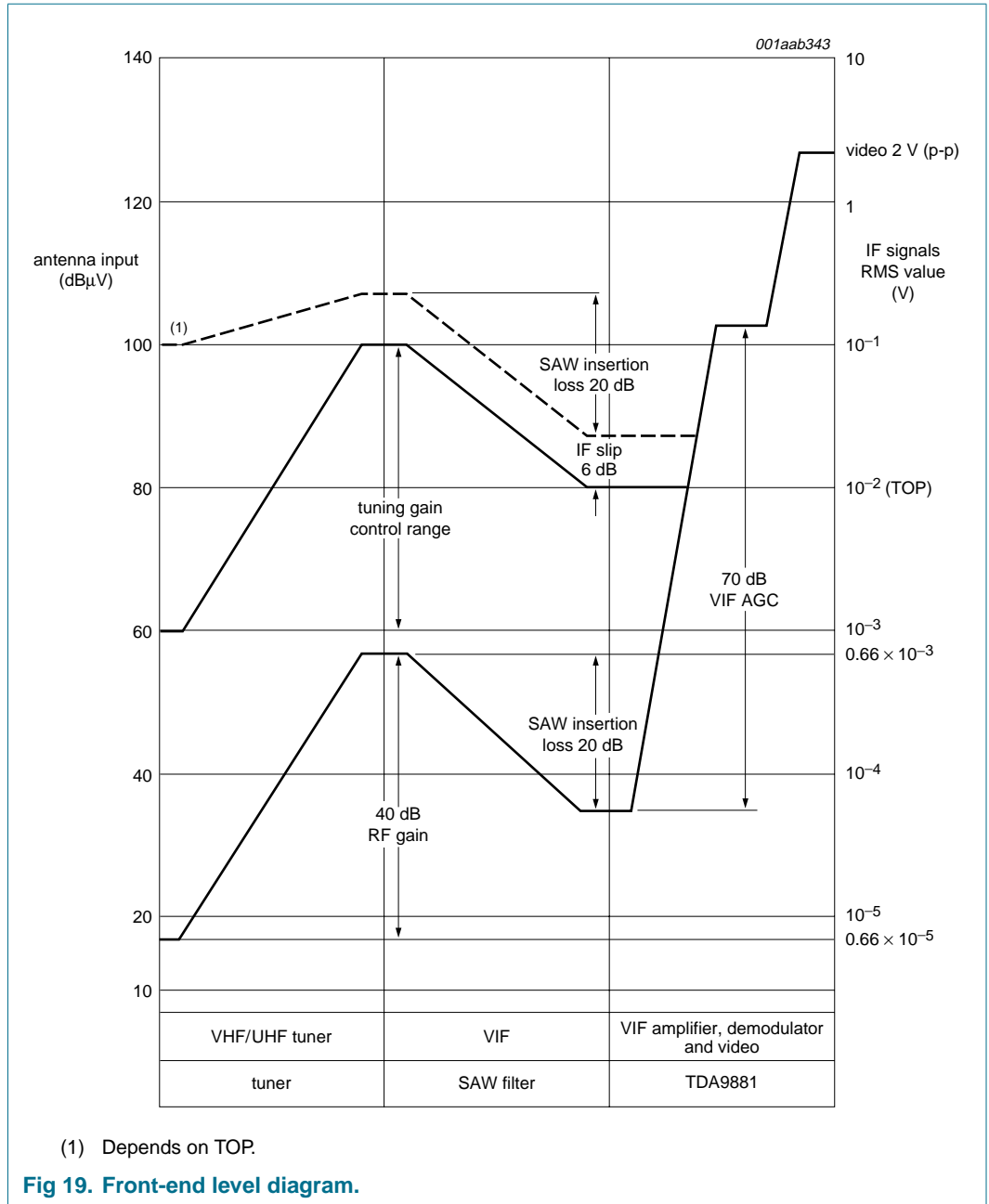



## 12. Application information

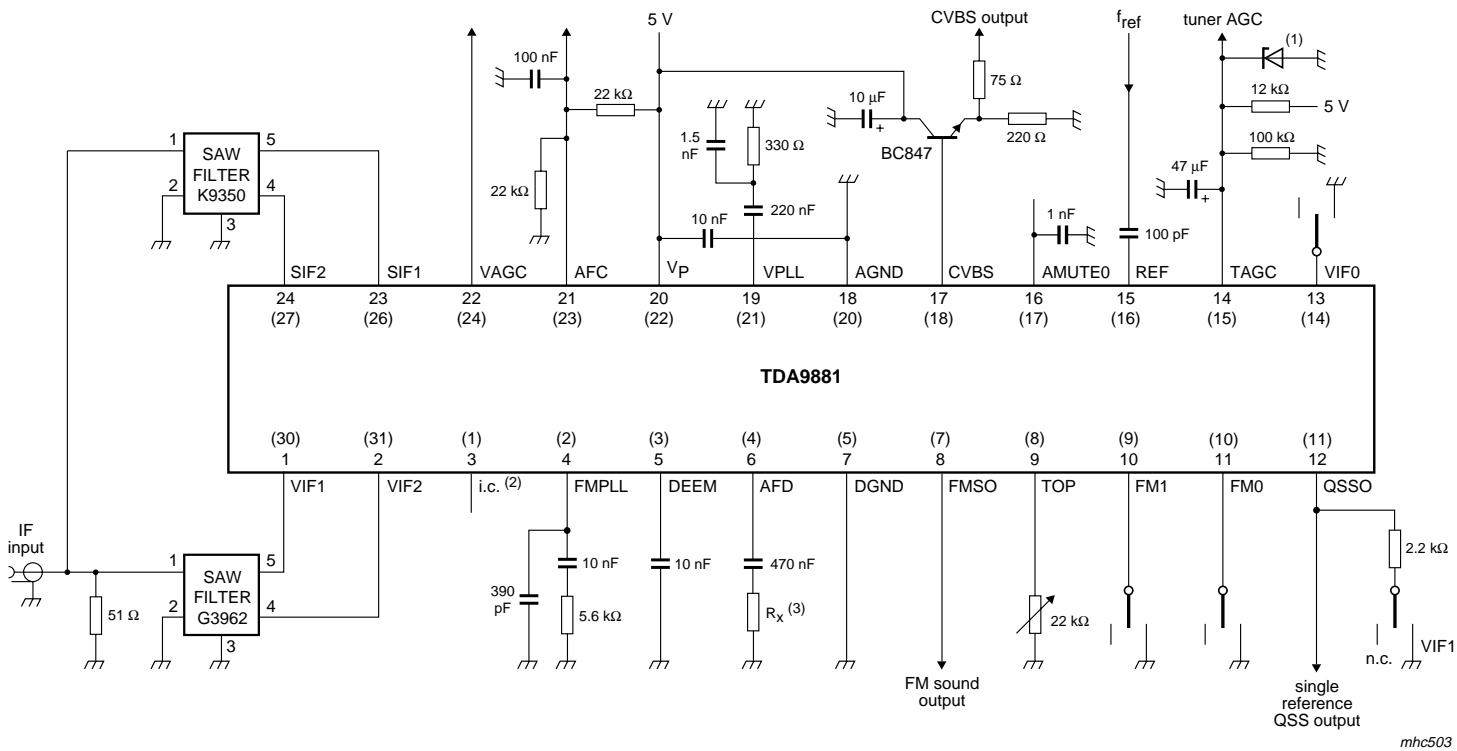

mhc503

Pin numbers for TDA9881HN in parenthesis.

- (1) Optional measures to improve ESD performance within a TV-set application.
- (2) Internal connected; the pin must be left open-circuit.
- (3) AF output signal reduction; see [Table note 19](#) of [Section 11](#).

Fig 20. Application diagram of TDA9881.

13. Test information

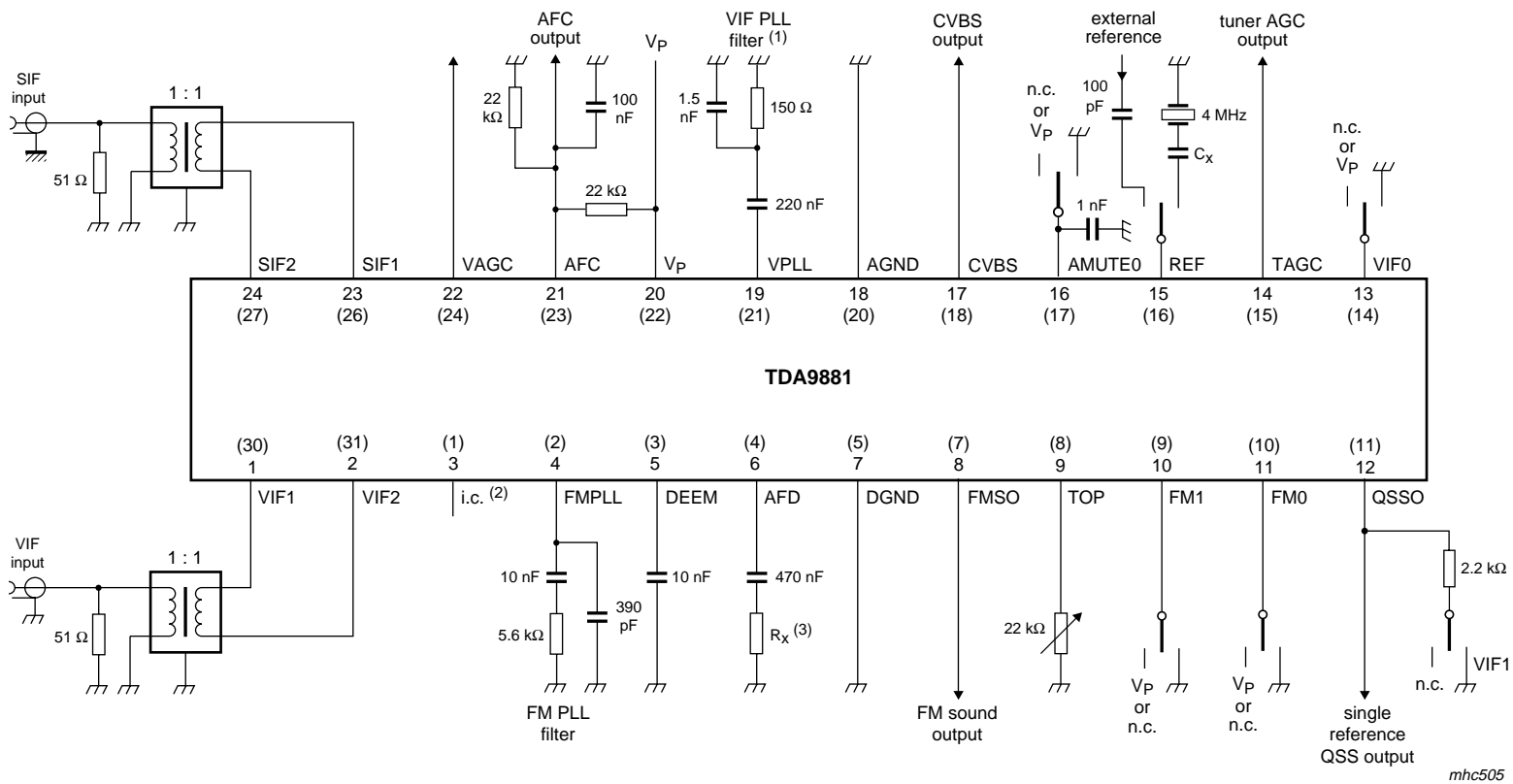

Pin numbers for TDA9881HN in parenthesis.

- (1) Different VIF loop filter in comparison with the application circuit due to different input characteristics (SAW filter or transformer).
- (2) Internal connected; the pin must be left open-circuit.
- (3) AF output signal reduction; see [Table note 19](#) of [Section 11](#).

Fig 21. Test circuit.

## 14. Package outline

SSOP24: plastic shrink small outline package; 24 leads; body width 5.3 mm

SOT340-1

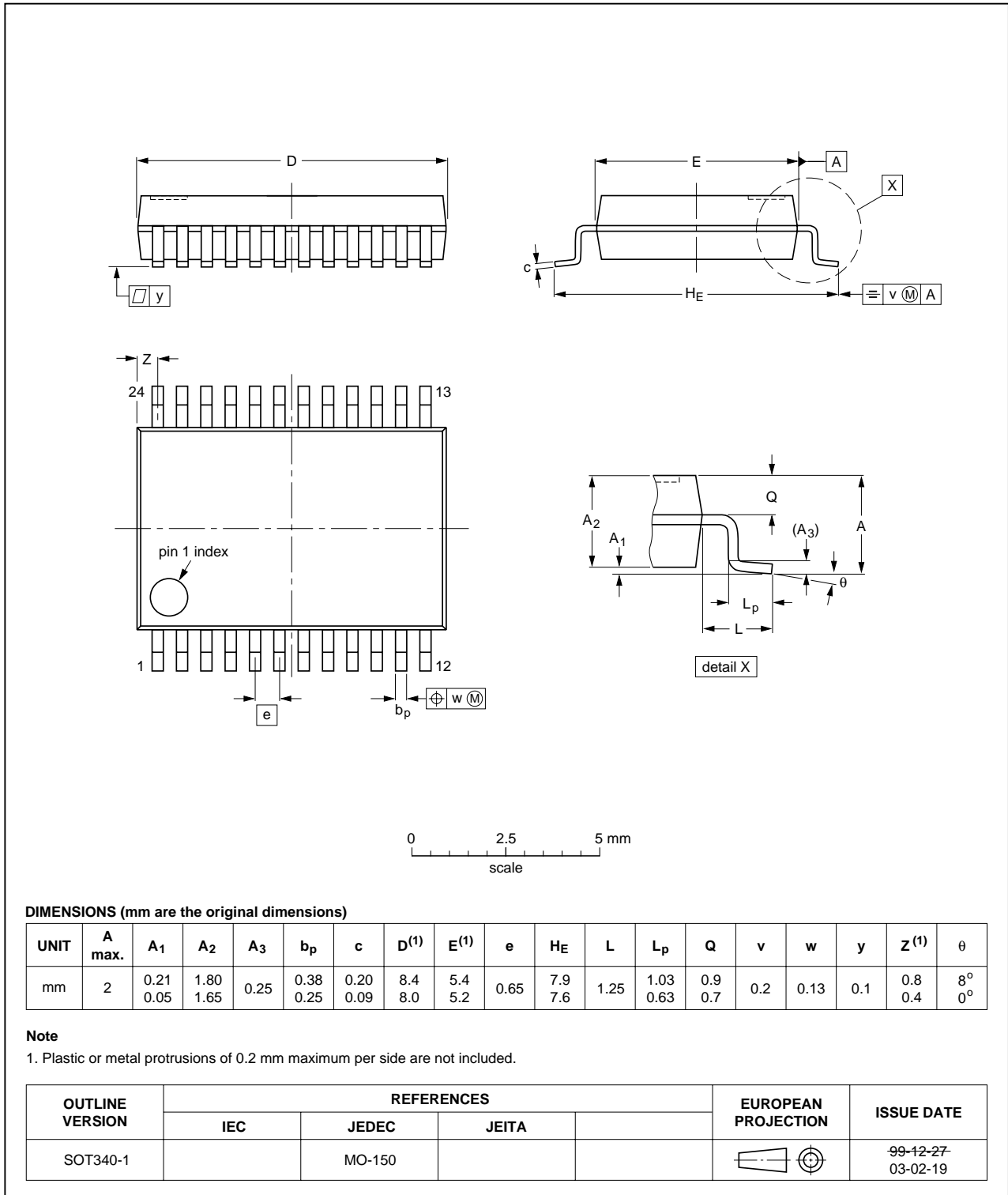

Fig 22. Package outline SOT340-1 (SSOP24).

HVQFN32: plastic thermal enhanced very thin quad flat package; no leads;  
32 terminals; body 5 x 5 x 0.85 mm

SOT617-3

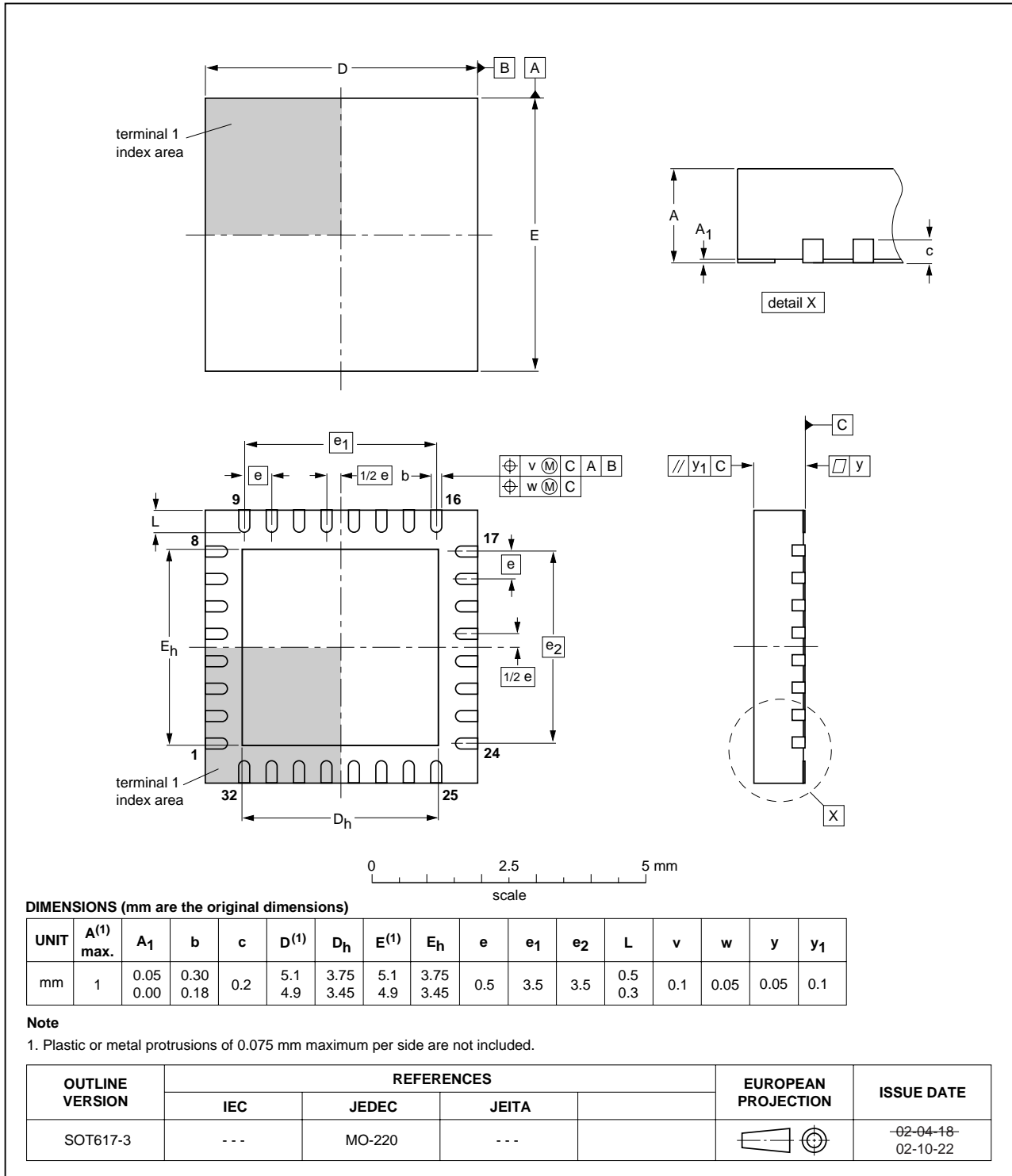

Fig 23. Package outline SOT617-3 (HVQFN32).

## 15. Soldering

### 15.1 Introduction to soldering surface mount packages

This text gives a very brief insight to a complex technology. A more in-depth account of soldering ICs can be found in our *Data Handbook IC26; Integrated Circuit Packages* (document order number 9398 652 90011).

There is no soldering method that is ideal for all surface mount IC packages. Wave soldering can still be used for certain surface mount ICs, but it is not suitable for fine pitch SMDs. In these situations reflow soldering is recommended.

### 15.2 Reflow soldering

Reflow soldering requires solder paste (a suspension of fine solder particles, flux and binding agent) to be applied to the printed-circuit board by screen printing, stencilling or pressure-syringe dispensing before package placement. Driven by legislation and environmental forces the worldwide use of lead-free solder pastes is increasing.

Several methods exist for reflowing; for example, convection or convection/infrared heating in a conveyor type oven. Throughput times (preheating, soldering and cooling) vary between 100 seconds and 200 seconds depending on heating method.

Typical reflow peak temperatures range from 215 °C to 270 °C depending on solder paste material. The top-surface temperature of the packages should preferably be kept:

- below 225 °C (SnPb process) or below 245 °C (Pb-free process)
  - for all BGA, HTSSON..T and SSOP..T packages
  - for packages with a thickness  $\geq 2.5$  mm
  - for packages with a thickness  $< 2.5$  mm and a volume  $\geq 350$  mm<sup>3</sup> so called thick/large packages.
- below 240 °C (SnPb process) or below 260 °C (Pb-free process) for packages with a thickness  $< 2.5$  mm and a volume  $< 350$  mm<sup>3</sup> so called small/thin packages.

Moisture sensitivity precautions, as indicated on packing, must be respected at all times.

### 15.3 Wave soldering

Conventional single wave soldering is not recommended for surface mount devices (SMDs) or printed-circuit boards with a high component density, as solder bridging and non-wetting can present major problems.

To overcome these problems the double-wave soldering method was specifically developed.

If wave soldering is used the following conditions must be observed for optimal results:

- Use a double-wave soldering method comprising a turbulent wave with high upward pressure followed by a smooth laminar wave.
- For packages with leads on two sides and a pitch (e):
  - larger than or equal to 1.27 mm, the footprint longitudinal axis is **preferred** to be parallel to the transport direction of the printed-circuit board;

- smaller than 1.27 mm, the footprint longitudinal axis **must** be parallel to the transport direction of the printed-circuit board.

The footprint must incorporate solder thieves at the downstream end.

- For packages with leads on four sides, the footprint must be placed at a 45° angle to the transport direction of the printed-circuit board. The footprint must incorporate solder thieves downstream and at the side corners.

During placement and before soldering, the package must be fixed with a droplet of adhesive. The adhesive can be applied by screen printing, pin transfer or syringe dispensing. The package can be soldered after the adhesive is cured.

Typical dwell time of the leads in the wave ranges from 3 seconds to 4 seconds at 250 °C or 265 °C, depending on solder material applied, SnPb or Pb-free respectively.

A mildly-activated flux will eliminate the need for removal of corrosive residues in most applications.

## 15.4 Manual soldering

Fix the component by first soldering two diagonally-opposite end leads. Use a low voltage (24 V or less) soldering iron applied to the flat part of the lead. Contact time must be limited to 10 seconds at up to 300 °C.

When using a dedicated tool, all other leads can be soldered in one operation within 2 seconds to 5 seconds between 270 °C and 320 °C.

## 15.5 Package related soldering information

**Table 13: Suitability of surface mount IC packages for wave and reflow soldering methods**

Package [1]	Soldering method	
	Wave	Reflow [2]
BGA, HTSSON..T [3], LBGA, LFBGA, SQFP, SSOP..T [3], TFBGA, VFBGA, XSON	not suitable	suitable
DHVQFN, HBCC, HBGA, HLQFP, HSO, HSOP, HSQFP, HSSON, HTQFP, HTSSOP, HVQFN, HVSON, SMS	not suitable [4]	suitable
PLCC [5], SO, SOJ	suitable	suitable
LQFP, QFP, TQFP	not recommended [5] [6]	suitable
SSOP, TSSOP, VSO, VSSOP	not recommended [7]	suitable
CWQCCN..L [8], PMFP [9], WQCCN..L [8]	not suitable	not suitable

[1] For more detailed information on the BGA packages refer to the *(LF)BGA Application Note (AN01026)*; order a copy from your Philips Semiconductors sales office.

[2] All surface mount (SMD) packages are moisture sensitive. Depending upon the moisture content, the maximum temperature (with respect to time) and body size of the package, there is a risk that internal or external package cracks may occur due to vaporization of the moisture in them (the so called popcorn effect). For details, refer to the Drypack information in the *Data Handbook IC26; Integrated Circuit Packages; Section: Packing Methods*.

[3] These transparent plastic packages are extremely sensitive to reflow soldering conditions and must on no account be processed through more than one soldering cycle or subjected to infrared reflow soldering with peak temperature exceeding 217 °C ± 10 °C measured in the atmosphere of the reflow oven. The package body peak temperature must be kept as low as possible.

- [4] These packages are not suitable for wave soldering. On versions with the heatsink on the bottom side, the solder cannot penetrate between the printed-circuit board and the heatsink. On versions with the heatsink on the top side, the solder might be deposited on the heatsink surface.
- [5] If wave soldering is considered, then the package must be placed at a 45° angle to the solder wave direction. The package footprint must incorporate solder thieves downstream and at the side corners.
- [6] Wave soldering is suitable for LQFP, QFP and TQFP packages with a pitch (e) larger than 0.8 mm; it is definitely not suitable for packages with a pitch (e) equal to or smaller than 0.65 mm.
- [7] Wave soldering is suitable for SSOP, TSSOP, VSO and VSSOP packages with a pitch (e) equal to or larger than 0.65 mm; it is definitely not suitable for packages with a pitch (e) equal to or smaller than 0.5 mm.
- [8] Image sensor packages in principle should not be soldered. They are mounted in sockets or delivered pre-mounted on flex foil. However, the image sensor package can be mounted by the client on a flex foil by using a hot bar soldering process. The appropriate soldering profile can be provided on request.
- [9] Hot bar soldering or manual soldering is suitable for PMFP packages.

## 16. Revision history

Table 14: Revision history

Document ID	Release date	Data sheet status	Change notice	Doc. number	Supersedes
TDA9881_1	20041116	Product data sheet	-	9397 750 13417	-



## 17. Data sheet status

Level	Data sheet status <sup>[1]</sup>	Product status <sup>[2]</sup> <sup>[3]</sup>	Definition
I	Objective data	Development	This data sheet contains data from the objective specification for product development. Philips Semiconductors reserves the right to change the specification in any manner without notice.
II	Preliminary data	Qualification	This data sheet contains data from the preliminary specification. Supplementary data will be published at a later date. Philips Semiconductors reserves the right to change the specification without notice, in order to improve the design and supply the best possible product.
III	Product data	Production	This data sheet contains data from the product specification. Philips Semiconductors reserves the right to make changes at any time in order to improve the design, manufacturing and supply. Relevant changes will be communicated via a Customer Product/Process Change Notification (CPCN).

[1] Please consult the most recently issued data sheet before initiating or completing a design.

[2] The product status of the device(s) described in this data sheet may have changed since this data sheet was published. The latest information is available on the Internet at URL <http://www.semiconductors.philips.com>.

[3] For data sheets describing multiple type numbers, the highest-level product status determines the data sheet status.

## 18. Definitions

**Short-form specification** — The data in a short-form specification is extracted from a full data sheet with the same type number and title. For detailed information see the relevant data sheet or data handbook.

**Limiting values definition** — Limiting values given are in accordance with the Absolute Maximum Rating System (IEC 60134). Stress above one or more of the limiting values may cause permanent damage to the device. These are stress ratings only and operation of the device at these or at any other conditions above those given in the Characteristics sections of the specification is not implied. Exposure to limiting values for extended periods may affect device reliability.

**Application information** — Applications that are described herein for any of these products are for illustrative purposes only. Philips Semiconductors make no representation or warranty that such applications will be suitable for the specified use without further testing or modification.

## 19. Disclaimers

**Life support** — These products are not designed for use in life support appliances, devices, or systems where malfunction of these products can reasonably be expected to result in personal injury. Philips Semiconductors customers using or selling these products for use in such applications do so at their own risk and agree to fully indemnify Philips Semiconductors for any damages resulting from such application.

**Right to make changes** — Philips Semiconductors reserves the right to make changes in the products - including circuits, standard cells, and/or software - described or contained herein in order to improve design and/or performance. When the product is in full production (status 'Production'), relevant changes will be communicated via a Customer Product/Process Change Notification (CPCN). Philips Semiconductors assumes no responsibility or liability for the use of any of these products, conveys no license or title under any patent, copyright, or mask work right to these products, and makes no representations or warranties that these products are free from patent, copyright, or mask work right infringement, unless otherwise specified.

## 20. Contact information

For additional information, please visit: <http://www.semiconductors.philips.com>

For sales office addresses, send an email to: [sales.addresses@www.semiconductors.philips.com](mailto:sales.addresses@www.semiconductors.philips.com)

## 21. Contents

<b>1</b>	<b>General description</b> .....	<b>1</b>
<b>2</b>	<b>Features</b> .....	<b>1</b>
<b>3</b>	<b>Applications</b> .....	<b>1</b>
<b>4</b>	<b>Quick reference data</b> .....	<b>2</b>
<b>5</b>	<b>Ordering information</b> .....	<b>3</b>
<b>6</b>	<b>Block diagram</b> .....	<b>4</b>
<b>7</b>	<b>Pinning information</b> .....	<b>5</b>
7.1	Pinning .....	5
7.2	Pin description .....	6
<b>8</b>	<b>Functional description</b> .....	<b>7</b>
8.1	VIF amplifier .....	7
8.2	Tuner AGC and VIF AGC .....	7
8.3	VIF AGC detector .....	7
8.4	FPLL detector .....	8
8.5	VCO and divider .....	8
8.6	AFC and digital acquisition help circuit .....	8
8.7	Video demodulator and amplifier .....	9
8.8	Sound carrier trap .....	9
8.9	SIF amplifier .....	9
8.10	SIF AGC detector .....	9
8.11	Single reference QSS mixer .....	10
8.12	FM demodulator and acquisition help circuit .....	10
8.13	Audio amplifier and mute time constant .....	11
8.14	Internal voltage stabilizer .....	11
8.15	Logic .....	11
<b>9</b>	<b>Limiting values</b> .....	<b>12</b>
<b>10</b>	<b>Thermal characteristics</b> .....	<b>13</b>
<b>11</b>	<b>Characteristics</b> .....	<b>13</b>
<b>12</b>	<b>Application information</b> .....	<b>33</b>
<b>13</b>	<b>Test information</b> .....	<b>34</b>
<b>14</b>	<b>Package outline</b> .....	<b>35</b>
<b>15</b>	<b>Soldering</b> .....	<b>37</b>
15.1	Introduction to soldering surface mount packages .....	37
15.2	Reflow soldering .....	37
15.3	Wave soldering .....	37
15.4	Manual soldering .....	38
15.5	Package related soldering information .....	38
<b>16</b>	<b>Revision history</b> .....	<b>40</b>
<b>17</b>	<b>Data sheet status</b> .....	<b>41</b>
<b>18</b>	<b>Definitions</b> .....	<b>41</b>
<b>19</b>	<b>Disclaimers</b> .....	<b>41</b>
<b>20</b>	<b>Contact information</b> .....	<b>41</b>



© Koninklijke Philips Electronics N.V. 2004

All rights are reserved. Reproduction in whole or in part is prohibited without the prior written consent of the copyright owner. The information presented in this document does not form part of any quotation or contract, is believed to be accurate and reliable and may be changed without notice. No liability will be accepted by the publisher for any consequence of its use. Publication thereof does not convey nor imply any license under patent- or other industrial or intellectual property rights.

Date of release: 16 November 2004  
Document number: 9397 750 13417

Published in The Netherlands