

DATA SHEET

TDA8560Q

**2 × 40 W/2 Ω stereo BTL car radio
power amplifier with diagnostic
facility**

Product specification
Supersedes data of March 1994
File under Integrated Circuits, IC01

1996 Jan 08

2 × 40 W/2 Ω stereo BTL car radio power amplifier with diagnostic facility

TDA8560Q

FEATURES

- Requires very few external components
- High output power
- 4 Ω and 2 Ω load impedance
- Low output offset voltage
- Fixed gain
- Diagnostic facility (distortion, short-circuit and temperature detection)
- Good ripple rejection
- Mode select switch (operating, mute and standby)
- Load dump protection
- Short-circuit safe to ground, to V_P and across the load
- Low power dissipation in any short-circuit condition
- Thermally protected
- Reverse polarity safe
- Electrostatic discharge protection
- No switch-on/switch-off plop
- Flexible leads
- Low thermal resistance.

GENERAL DESCRIPTION

The TDA8560Q is an integrated class-B output amplifier in a 13-lead single-in-line (SIL) power package. It contains 2 × 40 W/2 Ω amplifiers in BTL configuration.

The device is primarily developed for car radio applications.

QUICK REFERENCE DATA

SYMBOL	PARAMETER	CONDITIONS	MIN.	TYP.	MAX.	UNIT
V_P	operating supply voltage		6.0	14.4	18	V
I_{ORM}	repetitive peak output current		–	–	7.5	A
$I_{q(tot)}$	total quiescent current		–	115	–	mA
I_{sb}	standby current		–	0.1	100	μA
I_{sw}	switch-on current		–	–	40	μA
$ Z_i $	input impedance		25	30	–	kΩ
P_o	output power	$R_L = 4 \Omega$; THD = 10%	–	25	–	W
		$R_L = 2 \Omega$; THD = 10%	–	40	–	W
SVRR	supply voltage ripple rejection	$R_s = 0 \Omega$	–	45	–	dB
α_{cs}	channel separation	$R_s = 10 \text{ k}\Omega$	–	50	–	dB
G_v	closed loop voltage gain		39	40	41	dB
V_{no}	noise output voltage	$R_s = 0 \Omega$	–	–	250	μV
$ \Delta V_O $	DC output offset voltage		–	–	200	mV

ORDERING INFORMATION

TYPE NUMBER	PACKAGE		
	NAME	DESCRIPTION	VERSION
TDA8560Q	DBS13P	plastic DIL-bent-SIL power package; 13 leads (lead length 12 mm)	SOT141-6

2 × 40 W/2 Ω stereo BTL car radio
power amplifier with diagnostic facility

TDA8560Q

BLOCK DIAGRAM

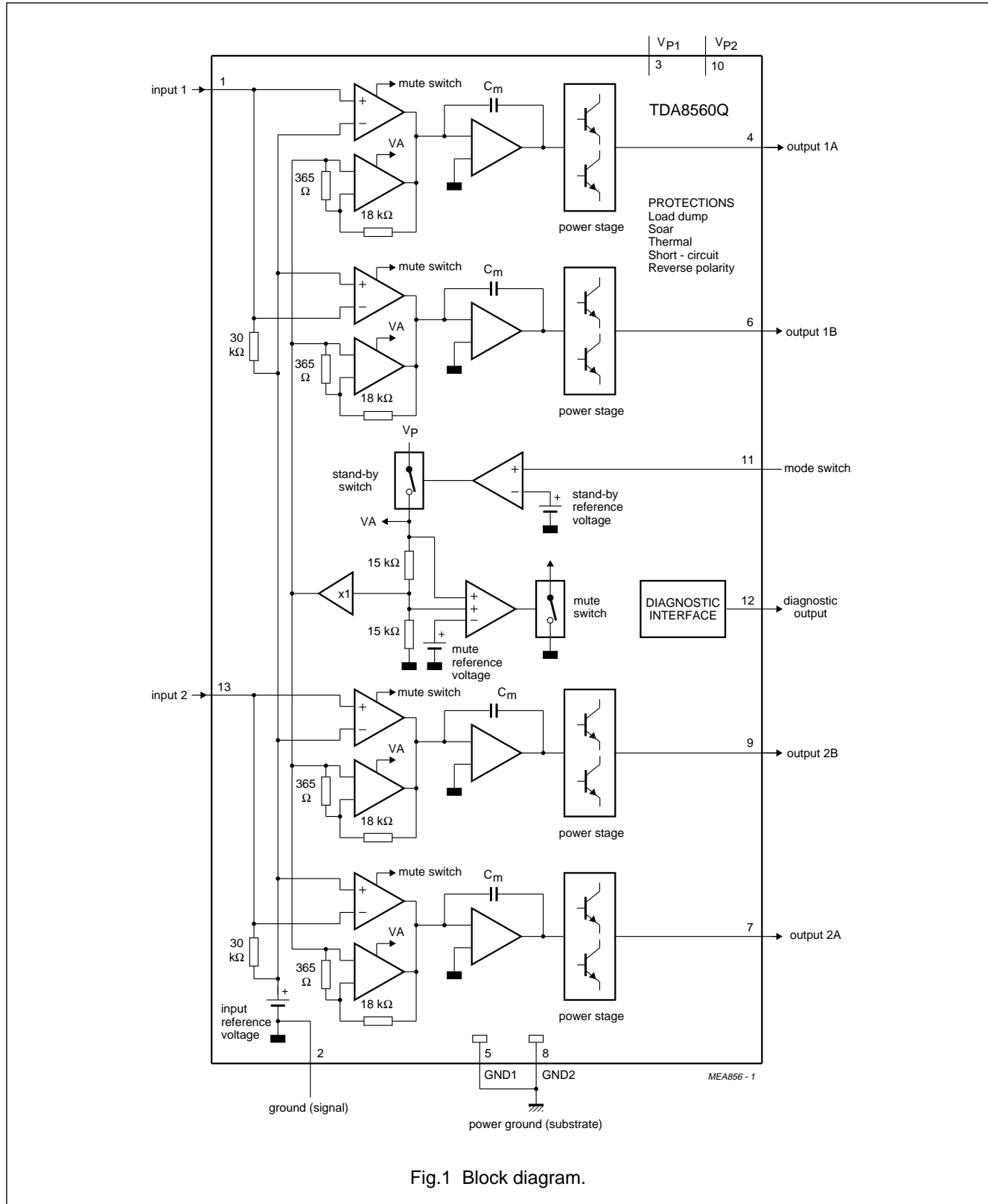

Fig.1 Block diagram.

**2 × 40 W/2 Ω stereo BTL car radio
power amplifier with diagnostic facility**

TDA8560Q

PINNING

SYMBOL	PIN	DESCRIPTION
IN 1	1	input 1
GND(S)	2	signal ground
V _{P1}	3	supply voltage 1
OUT 1A	4	output 1A
GND1	5	power ground 1
OUT 1B	6	output 1B
OUT 2A	7	output 2A
GND2	8	power ground 2
OUT 2B	9	output 2B
V _{P2}	10	supply voltage 2
MODE	11	mode switch input
V _{DIAG}	12	diagnostic output
IN 2	13	input 2

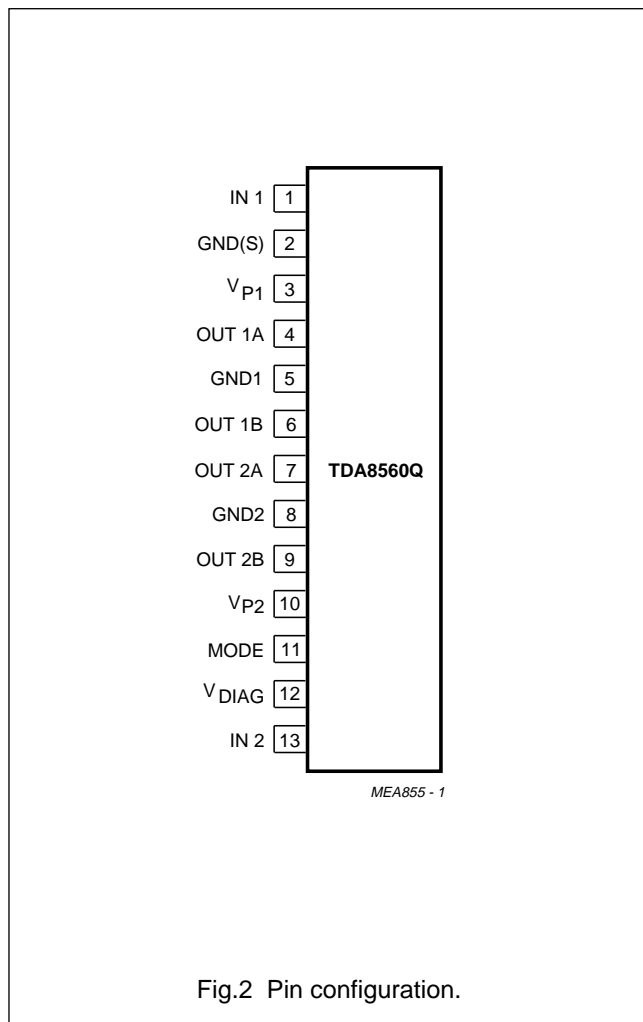

Fig.2 Pin configuration.

FUNCTIONAL DESCRIPTION

The TDA8560Q contains two identical amplifiers and can be used for bridge applications. The gain of each amplifier is fixed at 40 dB. Special features of the device are as follows.

Mode select switch (pin 11)

- Standby: low supply current (<100 μA)
- Mute: input signal suppressed
- Operating: normal on condition.

Since this pin has a very low input current (<40 μA), a low cost supply switch can be applied.

To avoid switch-on plops, it is advised to keep the amplifier in the mute mode during ≥100 ms (charging of the input capacitors at pin 1 and pin 13).

This can be achieved by:

- Microprocessor control
- External timing circuit (see Fig.7).

Diagnostic output (pin 12)

DYNAMIC DISTORTION DETECTOR (DDD)

At the onset of clipping of one or more output stages, the dynamic distortion detector becomes active and pin 12 goes low. This information can be used to drive a sound processor or DC volume control to attenuate the input signal and thus limit the distortion. The output level of pin 12 is independent of the number of channels that are clipping (see Fig.3).

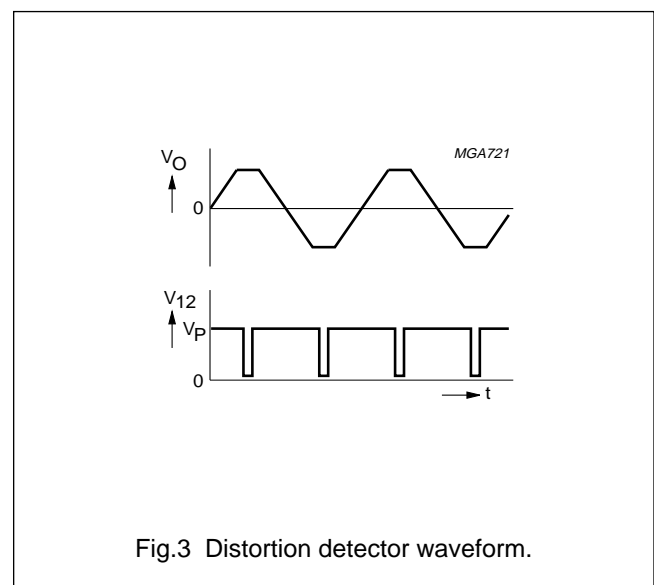

Fig.3 Distortion detector waveform.

2 × 40 W/2 Ω stereo BTL car radio power amplifier with diagnostic facility

TDA8560Q

SHORT-CIRCUIT PROTECTION

When a short-circuit occurs at one or more outputs to ground or to the supply voltage, the output stages are switched off until the short-circuit is removed and the device is switched on again, with a delay of approximately 20 ms, after removal of the short-circuit. During this short-circuit condition, pin 12 is continuously low.

When a short-circuit across the load of one or both channels occurs the output stages are switched off during approximately 20 ms. After that time it is checked during approximately 50 μs to see whether the short-circuit is still present. Due to this duty cycle of 50 μs/20 ms the average current consumption during this short-circuit condition is very low (approximately 40 mA).

During this short-circuit condition, pin 12 is low for 20 ms and high for 50 μs (see Fig.4).

The power dissipation in any short-circuit condition is very low.

TEMPERATURE DETECTION

When the virtual junction temperature T_{vj} reaches 150 °C, pin 12 will become continuously low.

OPEN COLLECTOR OUTPUT

Pin 12 is an open collector output, which allows pin 12 of more devices being tied together.

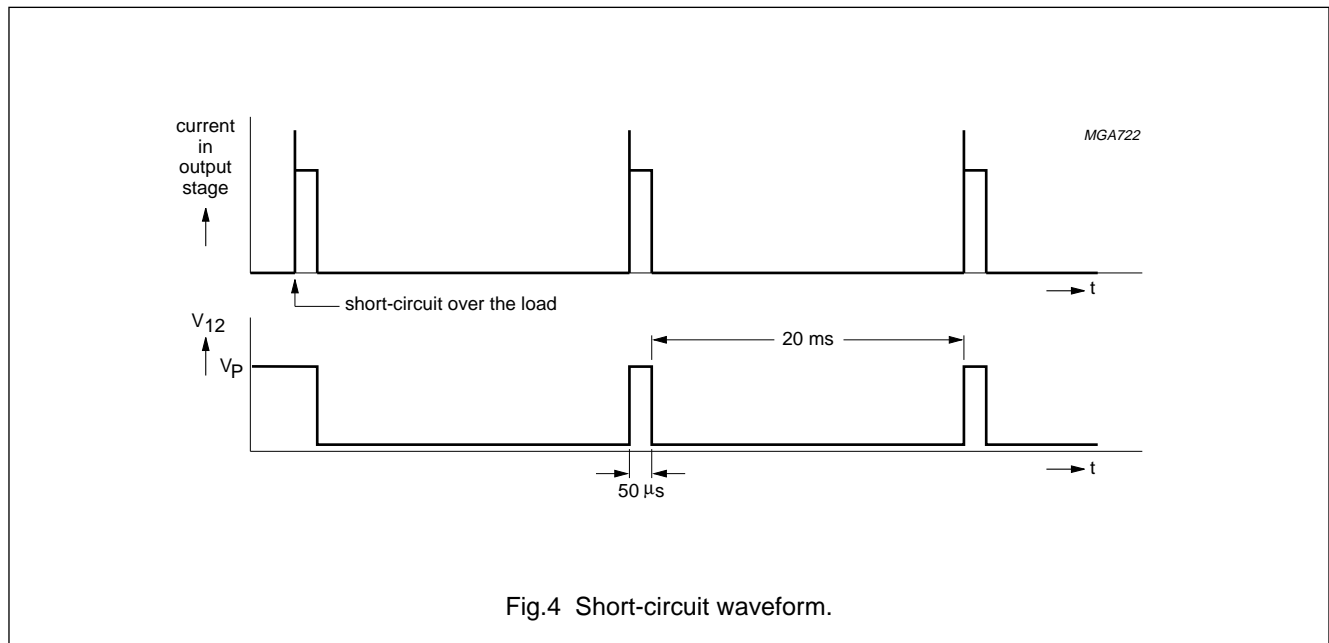

Fig.4 Short-circuit waveform.

**2 × 40 W/2 Ω stereo BTL car radio
power amplifier with diagnostic facility**

TDA8560Q

LIMITING VALUES

In accordance with the Absolute Maximum Rating System (IEC 134).

SYMBOL	PARAMETER	CONDITIONS	MIN.	MAX.	UNIT
V _P	supply voltage		–	18	V
	operating		–	30	V
	non-operating		–	45	V
	load dump protection	during 50 ms; t _r ≥ 2.5 ms	–	45	V
V _{psc}	AC and DC short-circuit safe voltage		–	18	V
V _{pr}	reverse polarity		–	6	V
I _{OSM}	non-repetitive peak output current		–	10	A
I _{ORM}	repetitive peak output current		–	7.5	A
P _{tot}	total power dissipation		–	60	W
T _{stg}	storage temperature		–55	+150	°C
T _{amb}	operating ambient temperature		–40	+85	°C
T _{vj}	virtual junction temperature		–	150	°C

THERMAL CHARACTERISTICS

SYMBOL	PARAMETER	VALUE	UNIT
R _{th j-a}	thermal resistance from junction to ambient in free air	40	K/W
R _{th j-c}	thermal resistance from junction to case (see Fig.5)	1.3	K/W

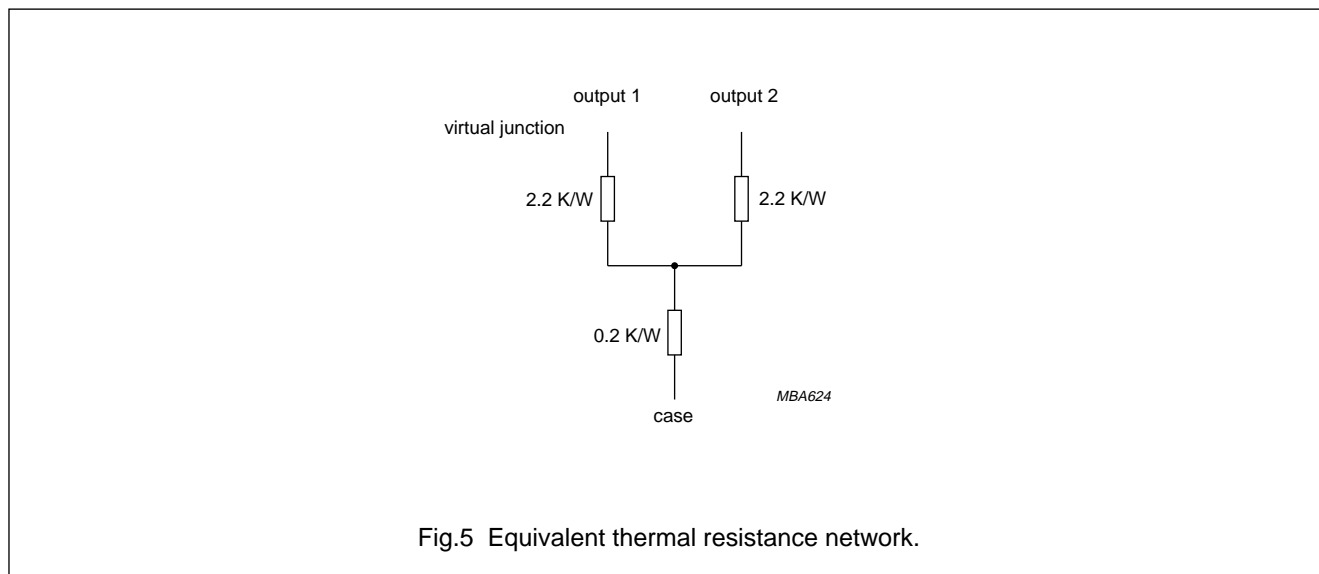

Fig.5 Equivalent thermal resistance network.

**2 × 40 W/2 Ω stereo BTL car radio
power amplifier with diagnostic facility**

TDA8560Q

DC CHARACTERISTICS

$V_P = 14.4\text{ V}$; $T_{amb} = 25\text{ °C}$; measured in Fig.6; unless otherwise specified.

SYMBOL	PARAMETER	CONDITIONS	MIN.	TYP.	MAX.	UNIT
Supply						
V_P	supply voltage	note 1	6.0	14.4	18	V
I_q	quiescent current	$R_L = \infty$	–	115	180	mA
Operating condition						
V_{11}	mode switch voltage level		8.5	–	V_P	V
I_{11}	mode switch current	$V_{11} = 14.4\text{ V}$	–	15	40	μA
V_O	DC output voltage	note 2	–	7.0	–	V
$ \Delta V_O $	DC output offset voltage		–	–	200	mV
Mute condition						
V_{11}	mode switch voltage level		3.3	–	6.4	V
V_O	DC output voltage	note 2	–	7.0	–	V
$ \Delta V_O $	DC output offset voltage		–	–	200	mV
Standby condition						
V_{11}	mode switch voltage level		0	–	2	V
I_{sb}	standby current		–	0.1	100	μA
Diagnostic output						
V_{12}	diagnostic output voltage	any short-circuit or clipping	–	–	0.6	V

Notes

1. The circuit is DC adjusted at $V_P = 6$ to 18 V and AC operating at $V_P = 8.5$ to 18 V .
2. At $18\text{ V} < V_P < 30\text{ V}$ the DC output voltage $\leq \frac{1}{2}V_P$.

2 × 40 W/2 Ω stereo BTL car radio power amplifier with diagnostic facility

TDA8560Q

AC CHARACTERISTICS

$V_P = 14.4\text{ V}$; $R_L = 2\ \Omega$; $f = 1\text{ kHz}$; $T_{\text{amb}} = 25\text{ °C}$; measured in Fig.6; unless otherwise specified.

SYMBOL	PARAMETER	CONDITIONS	MIN.	TYP.	MAX.	UNIT
P_o	output power	THD = 0.5%	25	30	–	W
		THD = 10%	33	40	–	W
		THD = 30%	45	55	–	W
P_o	output power	$V_P = 13.2\text{ V}$				
		THD = 0.5%	–	25	–	W
		THD = 10%	–	35	–	W
THD	total harmonic distortion	$P_o = 1\text{ W}$	–	0.1	–	%
		$V_{12} \leq 0.6\text{ V}$; note 1	–	10	–	%
B	power bandwidth	THD = 0.5%; $P_o = -1\text{ dB}$ with respect to 25 W	–	20 to 20000	–	Hz
f_{lr}	low frequency roll-off	at -1 dB ; note 2	–	25	–	Hz
f_{hr}	high frequency roll-off	at -1 dB	20	–	–	kHz
G_v	closed loop voltage gain		39	40	41	dB
SVRR	supply voltage ripple rejection					
	on	note 3	40	–	–	dB
	mute	note 3	50	–	–	dB
	standby	note 3	80	–	–	dB
$ Z_i $	input impedance		25	30	38	kΩ
V_{no}	noise output voltage					
	on	note 4	–	200	250	μV
	on	note 5	–	250	–	μV
	mute	note 6	–	135	–	μV
α_{cs}	channel separation	note 7	45	–	–	dB
$ \Delta G_v $	channel unbalance		–	–	1	dB
V_o	output voltage in mute	note 8	–	–	5	mV

Notes

- Dynamic distortion detector active.
- Frequency response externally fixed.
- $V_{\text{ripple}} = V_{\text{ripple(max)}} = 2\text{ V (p-p)}$; $R_s = 0\ \Omega$.
- $B = 20\text{ Hz to }20\text{ kHz}$; $R_s = 0\ \Omega$.
- $B = 20\text{ Hz to }20\text{ kHz}$; $R_s = 10\text{ k}\Omega$.
- $B = 20\text{ Hz to }20\text{ kHz}$; independent of R_s .
- $P_o = 25\text{ W}$; $R_s = 10\text{ k}\Omega$.
- $V_i = V_{i(\text{max})} = 1\text{ V (RMS)}$.

**2 × 40 W/2 Ω stereo BTL car radio
power amplifier with diagnostic facility**

TDA8560Q

AC CHARACTERISTICS

$V_P = 14.4\text{ V}$; $R_L = 4\ \Omega$; $f = 1\text{ kHz}$; $T_{amb} = 25\text{ °C}$; measured in Fig.6; unless otherwise specified.

SYMBOL	PARAMETER	CONDITIONS	MIN.	TYP.	MAX.	UNIT
P _o	output power	THD = 0.5%	16	19	–	W
		THD = 10%	21	25	–	W
		THD = 30%	28	35	–	W
P _o	output power	V _P = 13.2 V				
		THD = 0.5%	–	15	–	W
		THD = 10%	–	21	–	W
THD	total harmonic distortion	P _o = 1 W	–	0.1	–	%

**2 × 40 W/2 Ω stereo BTL car radio
power amplifier with diagnostic facility**

TDA8560Q

QUALITY SPECIFICATION

Quality in accordance with "Quality reference handbook SNW-FQ-611E", if this type used as an audio amplifier. This handbook can be ordered using the code 9397 750 00192.

TEST AND APPLICATION INFORMATION

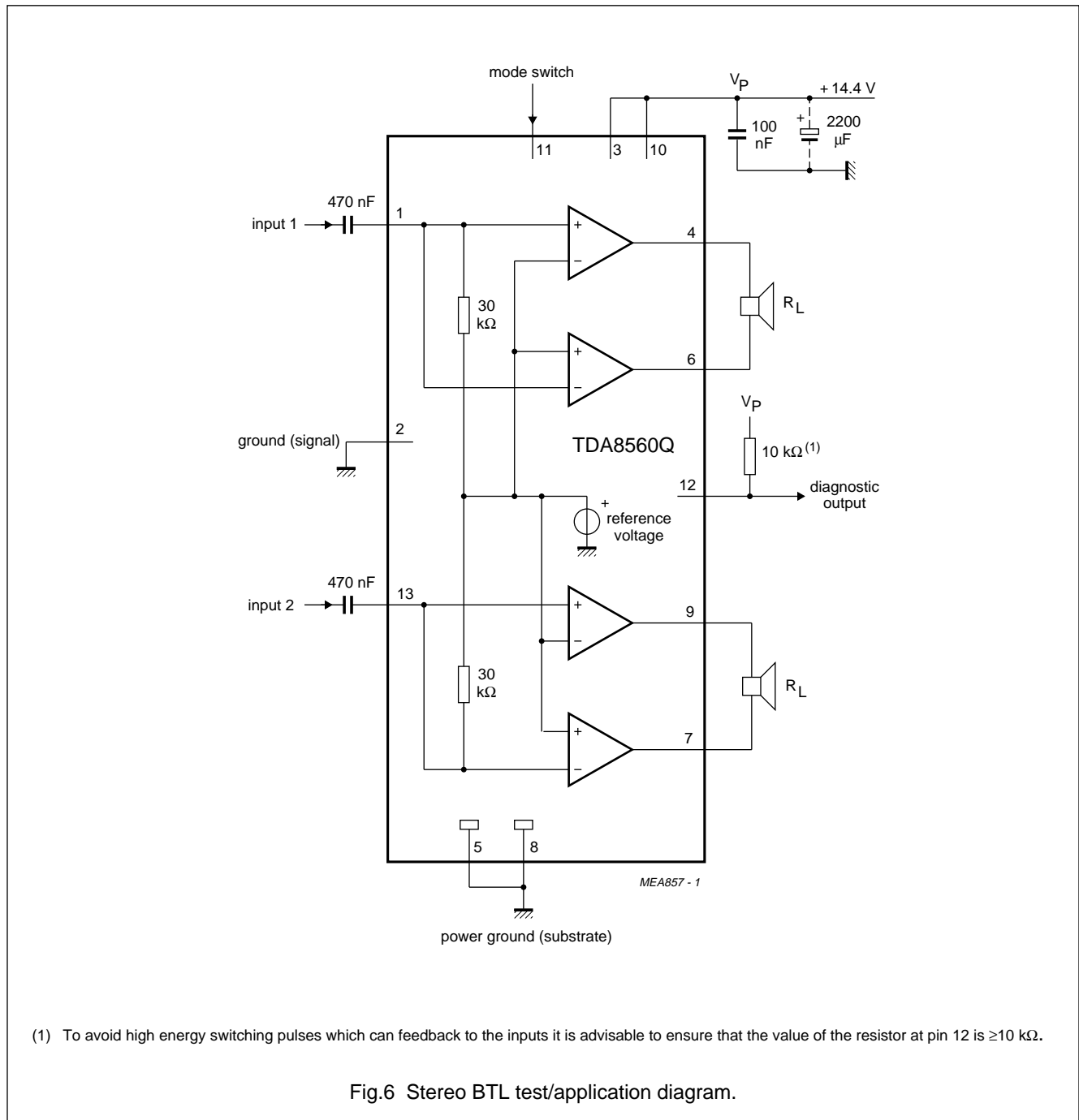

**2 × 40 W/2 Ω stereo BTL car radio
power amplifier with diagnostic facility**

TDA8560Q

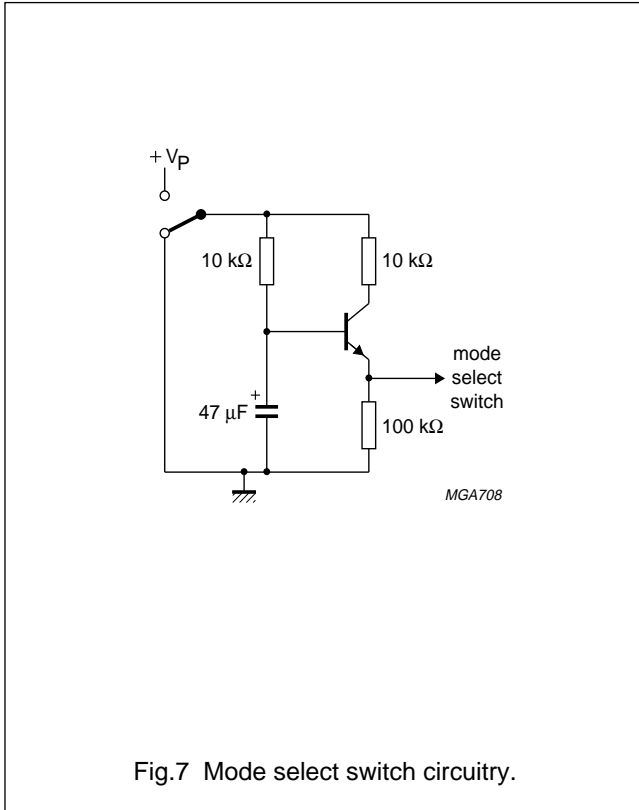

Fig.7 Mode select switch circuitry.

Diagnostic output

Special care must be taken in the printed-circuit board layout to separate pin 12 from pin 1 and pin 13, to minimize the crosstalk between the diagnostic output and the inputs.

Mode select switch

To avoid switch-on plops, it is advised to keep the amplifier in the mute mode during >100 ms (charging of the input capacitors at pin 1 and pin 13).

The circuit in Fig.7 slowly ramps up the voltage at the mode select switch pin when switching on and results in fast muting when switching off.

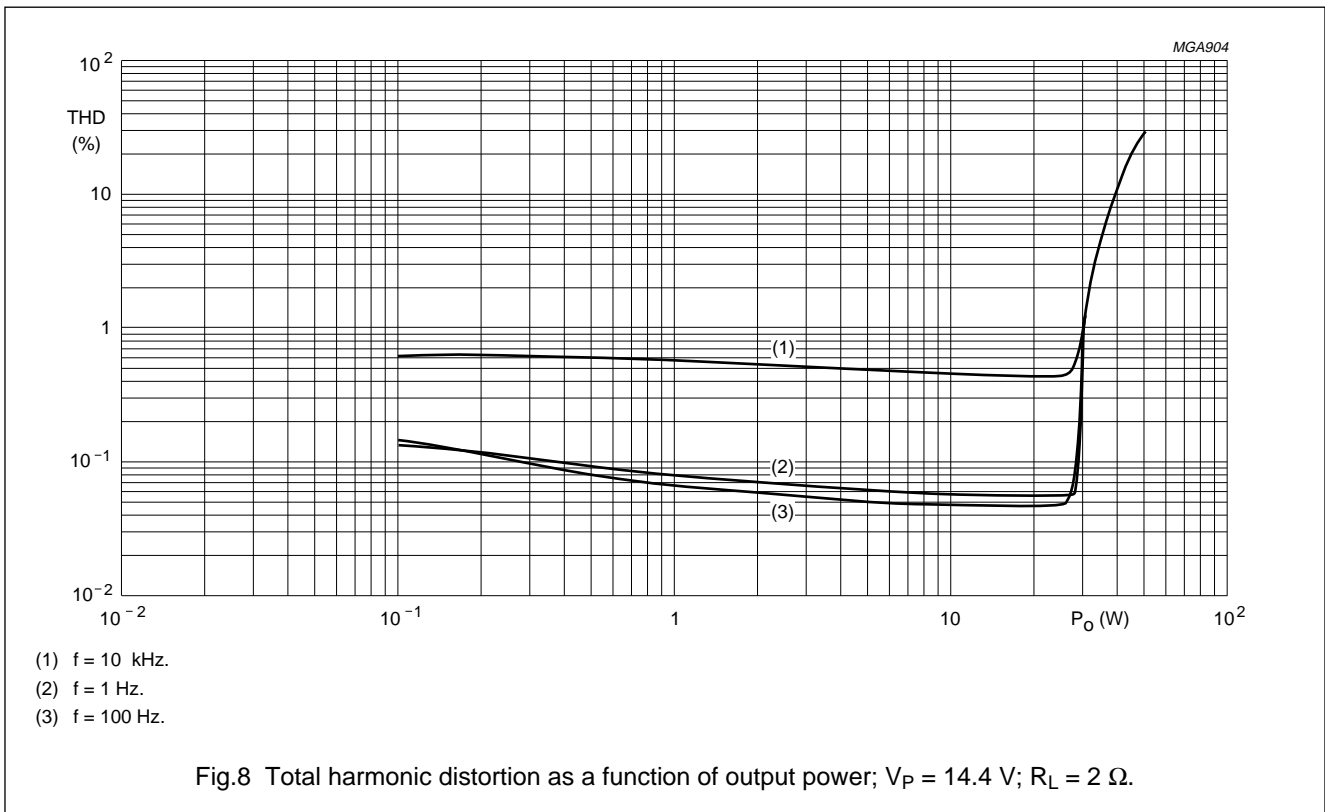
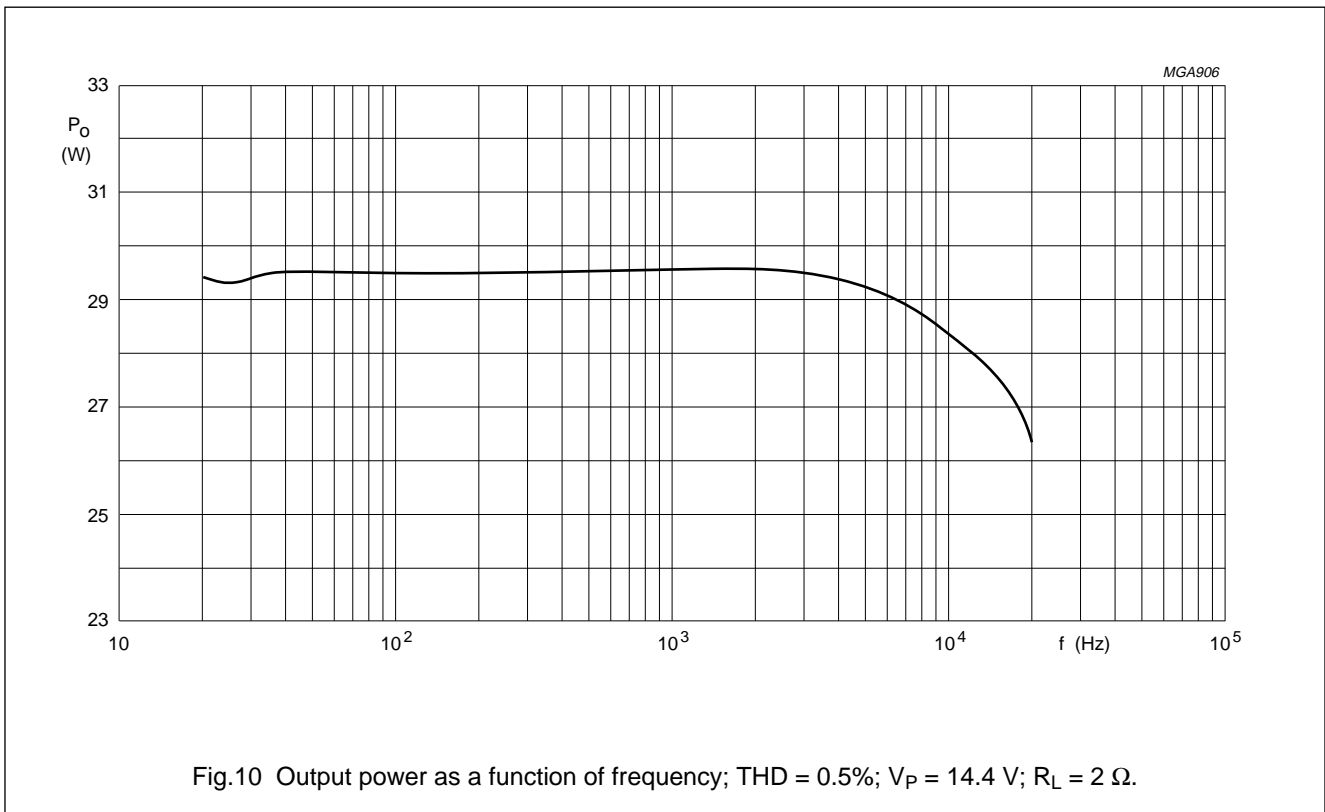
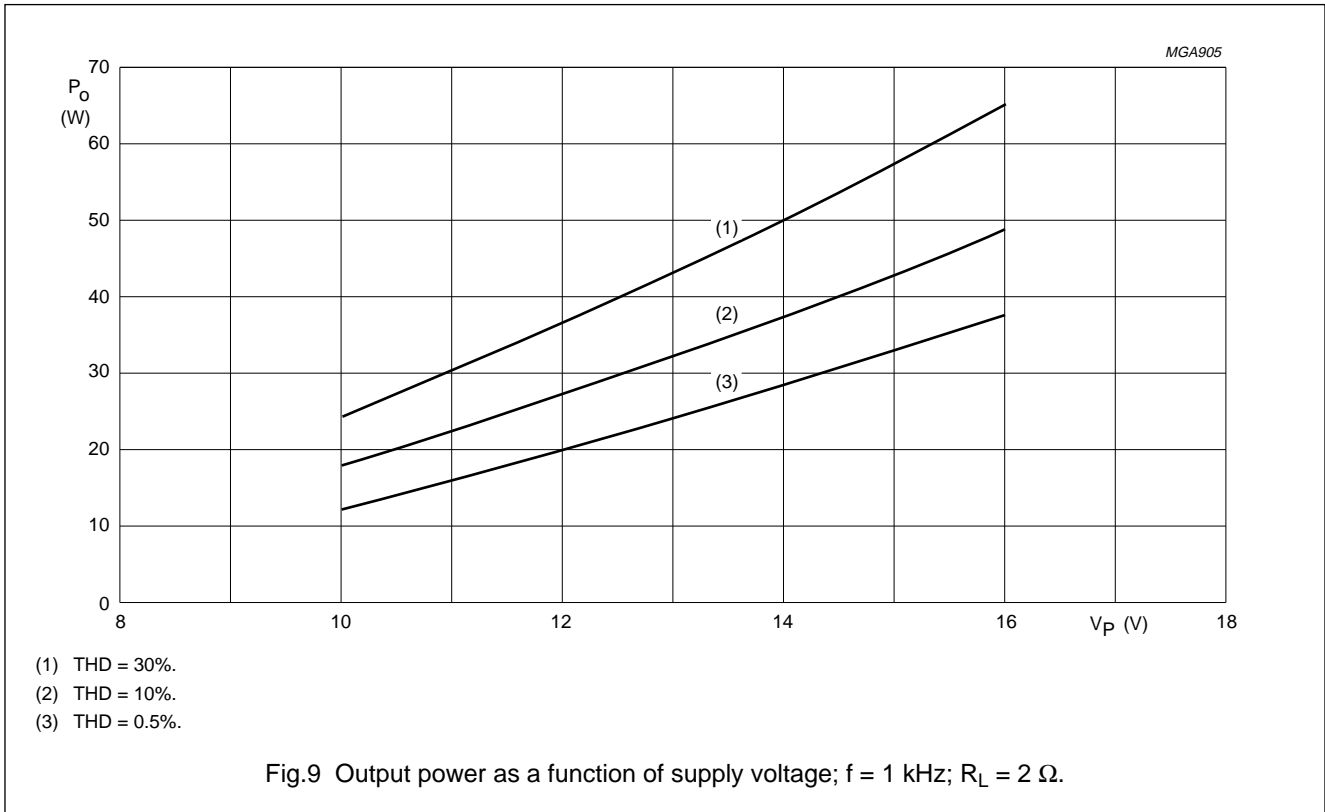

Fig.8 Total harmonic distortion as a function of output power; $V_p = 14.4 \text{ V}$; $R_L = 2 \Omega$.

**2 × 40 W/2 Ω stereo BTL car radio
power amplifier with diagnostic facility**

TDA8560Q



**2 × 40 W/2 Ω stereo BTL car radio
power amplifier with diagnostic facility**

TDA8560Q

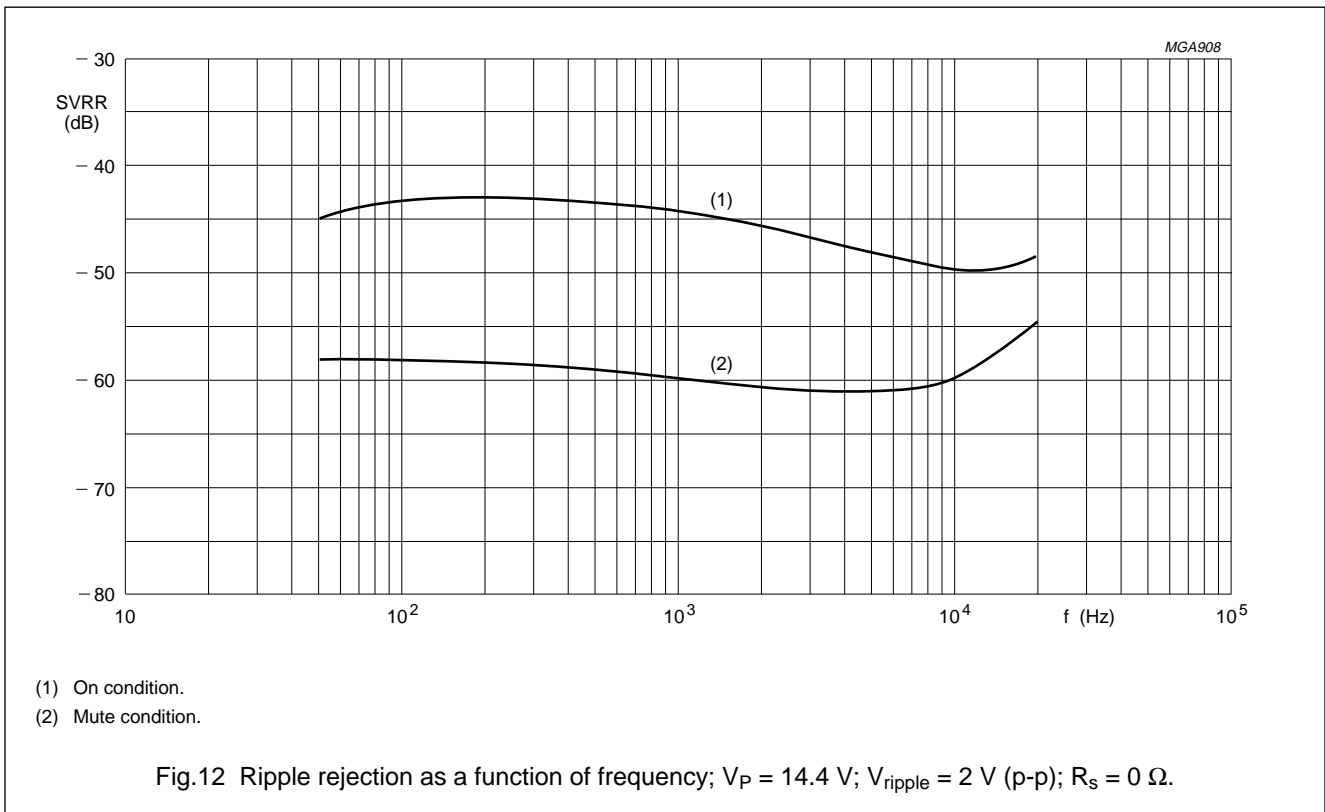
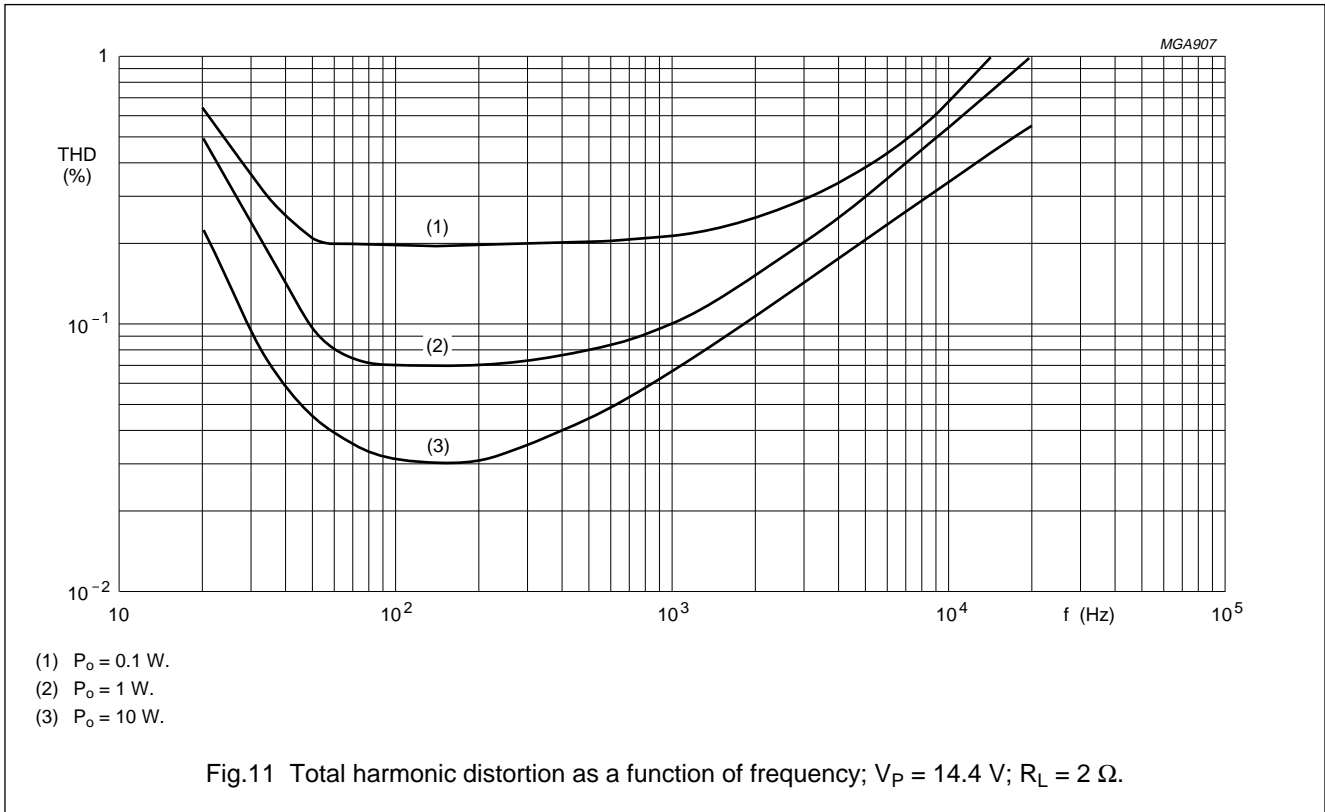

**2 × 40 W/2 Ω stereo BTL car radio
power amplifier with diagnostic facility**

TDA8560Q

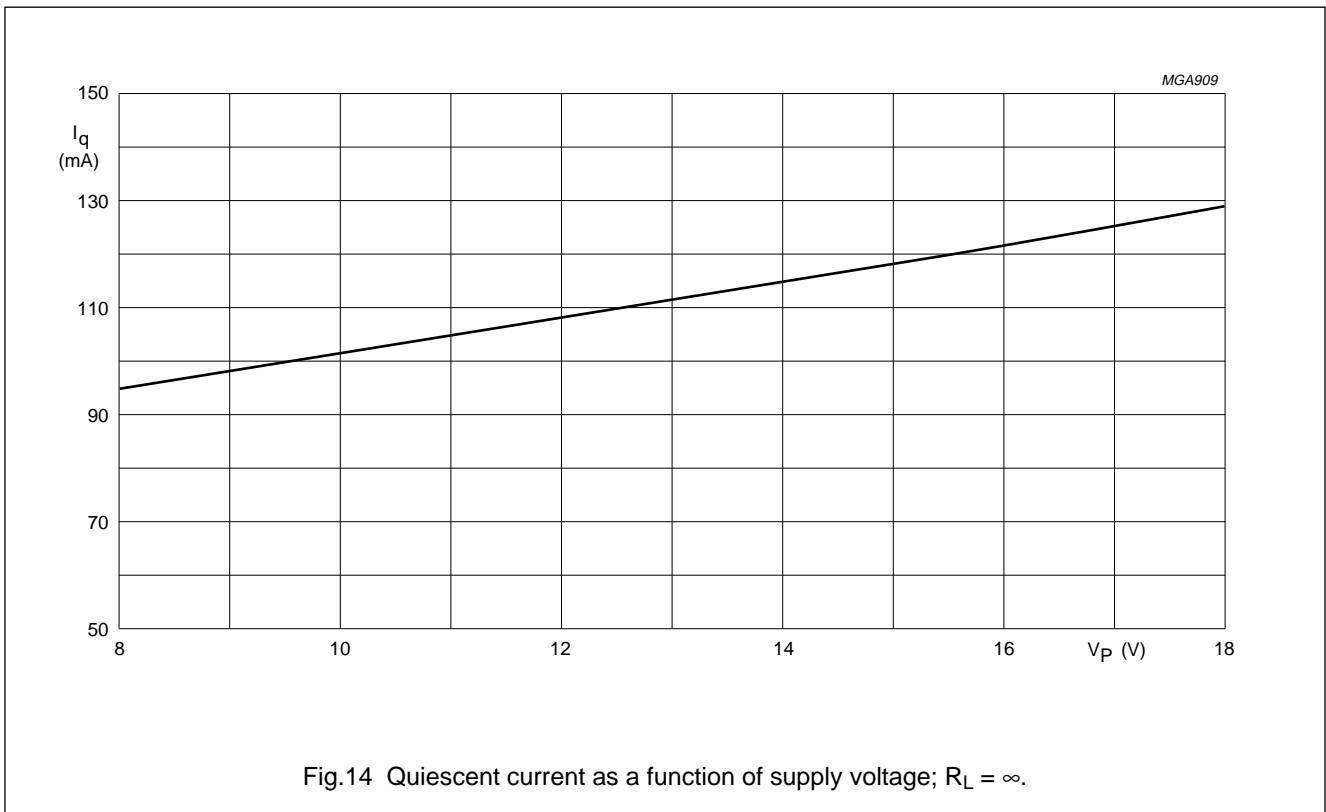
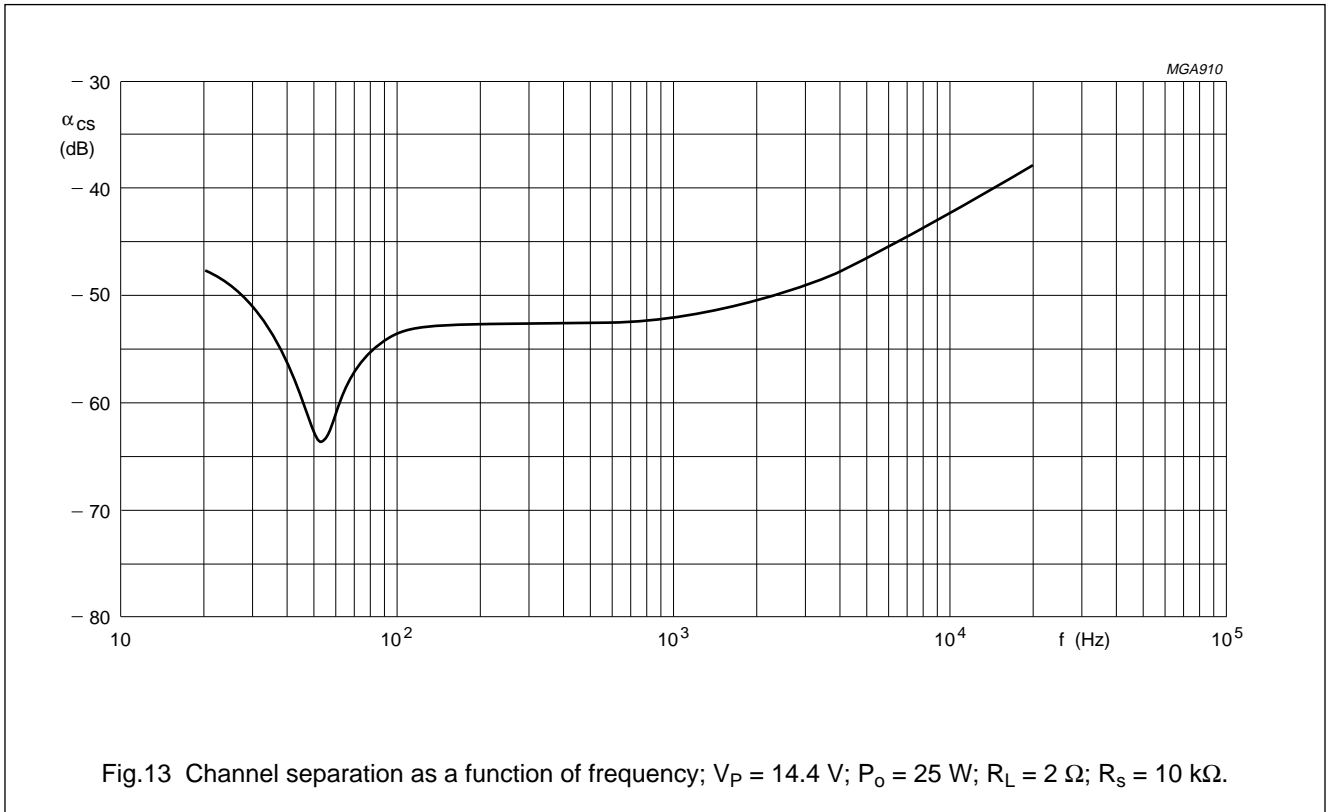

**2 × 40 W/2 Ω stereo BTL car radio
power amplifier with diagnostic facility**

TDA8560Q

PACKAGE OUTLINE

DBS13P: plastic DIL-bent-SIL power package; 13 leads (lead length 12 mm)

SOT141-6

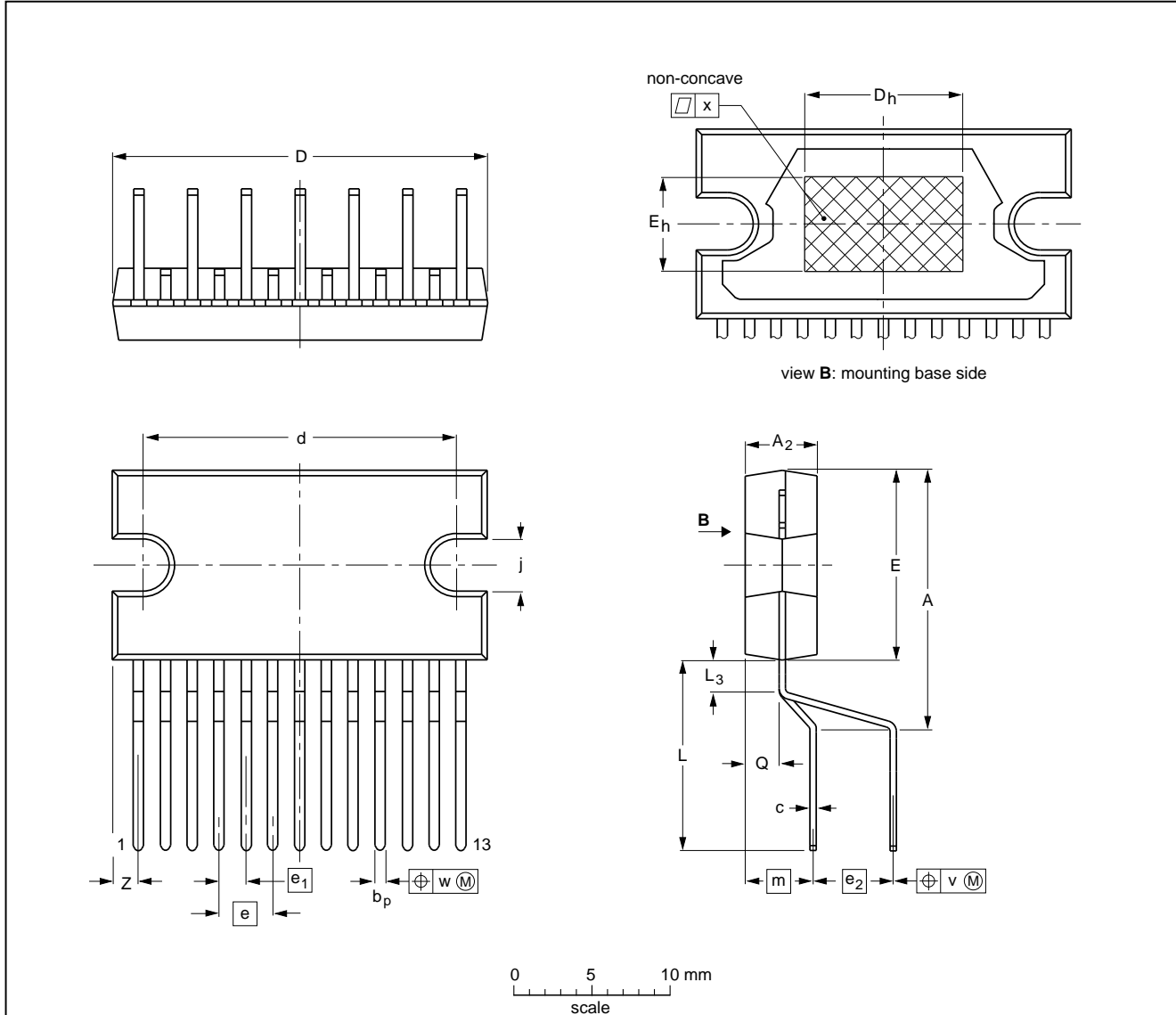

DIMENSIONS (mm are the original dimensions)

UNIT	A	A ₂	b _p	c	D ⁽¹⁾	d	D _h	E ⁽¹⁾	e	e ₁	e ₂	E _h	j	L	L ₃	m	Q	v	w	x	Z ⁽¹⁾
mm	17.0 15.5	4.6 4.2	0.75 0.60	0.48 0.38	24.0 23.6	20.0 19.6	10	12.2 11.8	3.4	1.7	5.08	6	3.4 3.1	12.4 11.0	2.4 1.6	4.3	2.1 1.8	0.8	0.25	0.03	2.00 1.45

Note

1. Plastic or metal protrusions of 0.25 mm maximum per side are not included.

OUTLINE VERSION	REFERENCES			EUROPEAN PROJECTION	ISSUE DATE
	IEC	JEDEC	EIAJ		
SOT141-6					92-11-17 95-03-11

2 × 40 W/2 Ω stereo BTL car radio power amplifier with diagnostic facility

TDA8560Q

SOLDERING

Introduction

There is no soldering method that is ideal for all IC packages. Wave soldering is often preferred when through-hole and surface mounted components are mixed on one printed-circuit board. However, wave soldering is not always suitable for surface mounted ICs, or for printed-circuits with high population densities. In these situations reflow soldering is often used.

This text gives a very brief insight to a complex technology. A more in-depth account of soldering ICs can be found in our "IC Package Databook" (order code 9398 652 90011).

Soldering by dipping or by wave

The maximum permissible temperature of the solder is 260 °C; solder at this temperature must not be in contact with the joint for more than 5 seconds. The total contact time of successive solder waves must not exceed 5 seconds.

DEFINITIONS

Data sheet status	
Objective specification	This data sheet contains target or goal specifications for product development.
Preliminary specification	This data sheet contains preliminary data; supplementary data may be published later.
Product specification	This data sheet contains final product specifications.
Limiting values	
Limiting values given are in accordance with the Absolute Maximum Rating System (IEC 134). Stress above one or more of the limiting values may cause permanent damage to the device. These are stress ratings only and operation of the device at these or at any other conditions above those given in the Characteristics sections of the specification is not implied. Exposure to limiting values for extended periods may affect device reliability.	
Application information	
Where application information is given, it is advisory and does not form part of the specification.	

LIFE SUPPORT APPLICATIONS

These products are not designed for use in life support appliances, devices, or systems where malfunction of these products can reasonably be expected to result in personal injury. Philips customers using or selling these products for use in such applications do so at their own risk and agree to fully indemnify Philips for any damages resulting from such improper use or sale.

The device may be mounted up to the seating plane, but the temperature of the plastic body must not exceed the specified maximum storage temperature ($T_{stg\ max}$). If the printed-circuit board has been pre-heated, forced cooling may be necessary immediately after soldering to keep the temperature within the permissible limit.

Repairing soldered joints

Apply a low voltage soldering iron (less than 24 V) to the lead(s) of the package, below the seating plane or not more than 2 mm above it. If the temperature of the soldering iron bit is less than 300 °C it may remain in contact for up to 10 seconds. If the bit temperature is between 300 and 400 °C, contact may be up to 5 seconds.