

DATA SHEET

TDA8543 2 W BTL audio amplifier

Product specification
File under Integrated Circuits, IC01

1997 Jun 12

2 W BTL audio amplifier**TDA8543****FEATURES**

- Flexibility in use
- Few external components
- Low saturation voltage of output stage
- Gain can be fixed with external resistors
- Standby mode controlled by CMOS compatible levels
- Low standby current
- No switch-on/switch-off plops
- High supply voltage ripple rejection
- Protected against electrostatic discharge
- Outputs short-circuit safe to ground, V_{CC} and across the load
- Thermally protected.

GENERAL DESCRIPTION

The TDA8543(T) is a one channel audio power amplifier for an output power of 2 W with an 8 Ω load at a 7.5 V supply. The circuit contains a BTL amplifier with a complementary PNP-NPN output stage and standby/mute logic. The TDA8543T comes in a 16 pin SO package and the TDA8543 in a 16 pin DIP package.

APPLICATIONS

- Portable consumer products
- Personal computers
- Telephony.

QUICK REFERENCE DATA

SYMBOL	PARAMETER	CONDITIONS	MIN.	TYP.	MAX.	UNIT
V_{CC}	supply voltage		2.2	5	18	V
I_q	quiescent current	$V_{CC} = 5\text{ V}$	–	8	12	mA
I_{stb}	standby current		–	–	10	μA
P_o	output power	THD = 10% $R_L = 8\ \Omega; V_{CC} = 5\text{ V}$ $R_L = 8\ \Omega; V_{CC} = 7.5\text{ V}$ $R_L = 16\ \Omega; V_{CC} = 9\text{ V}$	1	1.2	–	W
THD	total harmonic distortion	$P_o = 0.5\text{ W}$	–	0.15	–	%
SVRR	supply voltage ripple rejection		50	–	–	dB

ORDERING INFORMATION

TYPE NUMBER	PACKAGE		
	NAME	DESCRIPTION	VERSION
TDA8543T	SO16	plastic small outline package; 16 leads; body width 3.9 mm	SOT109-1
TDA8543	DIP16	plastic dual in-line package; 16 leads (300 mil); long body	SOT38-1

2 W BTL audio amplifier

TDA8543

BLOCK DIAGRAM

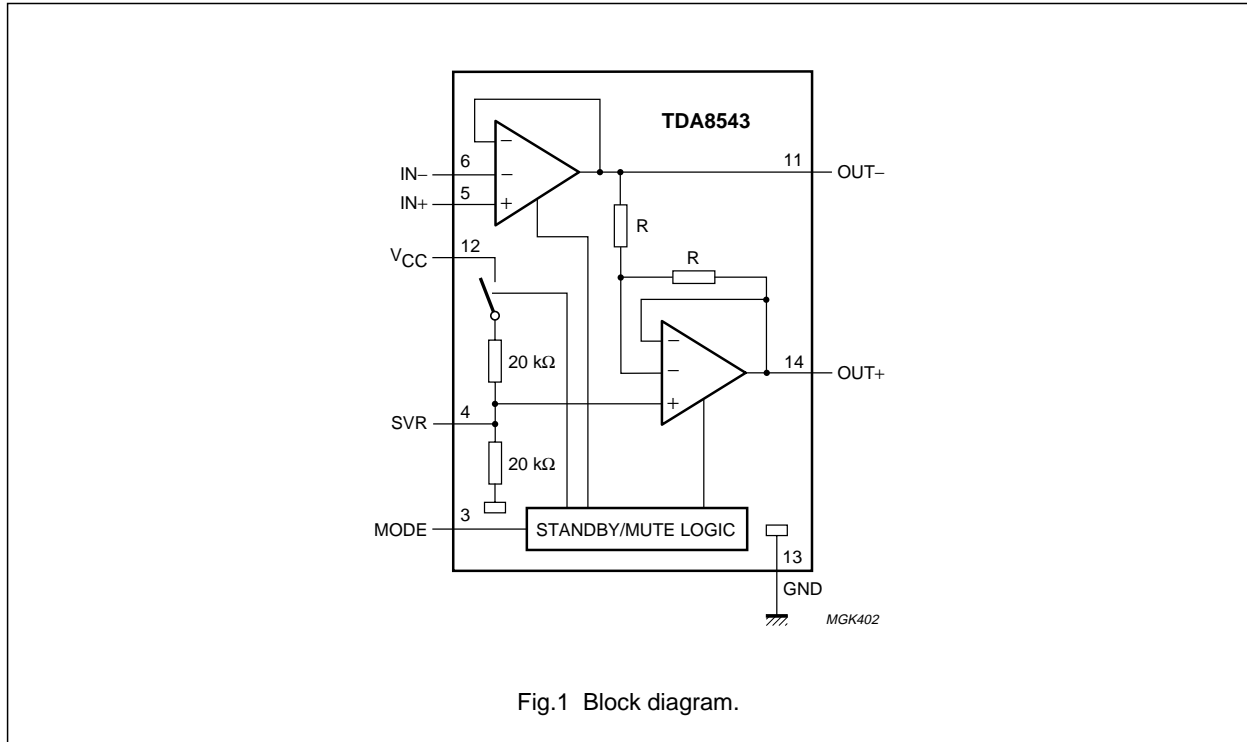

PINNING

SYMBOL	PIN	DESCRIPTION
n.c.	1	not connected
n.c.	2	not connected
MODE	3	operating mode select (standby, mute, operating)
SVR	4	half supply voltage, decoupling ripple rejection
IN+	5	positive input
IN-	6	negative input
n.c.	7	not connected
n.c.	8	not connected
n.c.	9	not connected
n.c.	10	not connected
OUT-	11	negative loudspeaker terminal
V _{CC}	12	supply voltage
GND	13	ground
OUT+	14	positive loudspeaker terminal
n.c.	15	not connected
n.c.	16	not connected

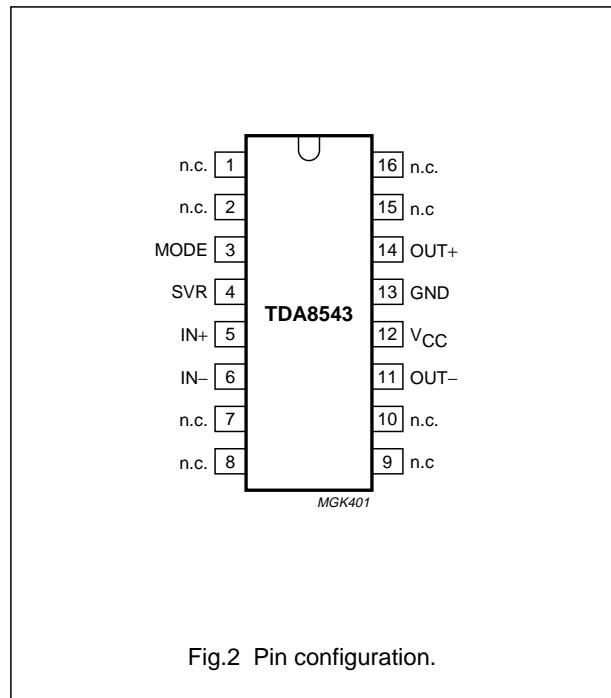

2 W BTL audio amplifier

TDA8543

FUNCTIONAL DESCRIPTION

The TDA8543(T) is a BTL audio power amplifier capable of delivering an output power between 1 and 2 W, depending on supply voltage, load resistance and package. Using the MODE pin the device can be switched to standby and mute condition. The device is protected by an internal thermal shutdown protection mechanism.

The gain can be set within a range from 6 dB to 30 dB by external feedback resistors.

Power amplifier

The power amplifier is a Bridge Tied Load (BTL) amplifier with a complementary PNP-NPN output stage.

The voltage loss on the positive supply line is the saturation voltage of a PNP power transistor, on the negative side the saturation voltage of an NPN power transistor.

Mode select pin

The device is in standby mode (with a very low current consumption) if the voltage at the MODE pin is $>(V_{CC} - 0.5 \text{ V})$, or if this pin is floating. At a MODE voltage level of less than 0.5 V the amplifier is fully operational.

In the range between 1.5 V and $V_{CC} - 1.5 \text{ V}$ the amplifier is in mute condition. The mute condition is useful to suppress plop noise at the output, caused by charging of the input capacitor.

LIMITING VALUES

In accordance with the Absolute Maximum Rating System (IEC 134).

SYMBOL	PARAMETER	CONDITIONS	MIN.	MAX.	UNIT
V_{CC}	supply voltage	operating	-0.3	+18	V
V_I	input voltage		-0.3	$V_{CC} + 0.3$	V
I_{ORM}	repetitive peak output current		-	1	A
T_{stg}	storage temperature	non-operating	-55	+150	°C
T_{amb}	operating ambient temperature		-40	+85	°C
V_{psc}	AC and DC short-circuit safe voltage		-	10	V
P_{tot}	total power dissipation	SO16	-	1.2	W
		DIP16	-	2.2	W

QUALITY SPECIFICATION

In accordance with "SNW-FQ-611-E". The number of the quality specification can be found in the "Quality Reference Handbook". The handbook can be ordered using the code 9397 750 00192.

THERMAL CHARACTERISTICS

SYMBOL	PARAMETER	CONDITIONS	VALUE	UNIT
$R_{th\ j-a}$	thermal resistance from junction to ambient	in free air		
	TDA8543T (SO16)		100	K/W
	TDA8543 (DIP16)		55	K/W

2 W BTL audio amplifier

TDA8543

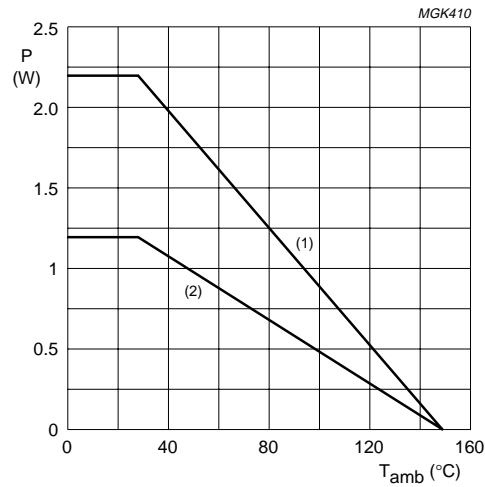

- (1) DIP16.
(2) SO16.

Fig.3 Power derating curve.

Table 1

V _{CC} (V)	R _L (Ω)	P _O (W) ⁽¹⁾	CONTINUOUS SINE WAVE DRIVEN		
			P _{max} (W)	T _{amb(max)} (°C)	
				SO16	DIP16
5	8	1.2	0.7	80	112
7.5	8	2.2	1.6	–	62
7.5	16	1.4	0.9	60	100
9	16	2.0	1.3	–	78
9	25	1.3	0.9	60	100

Note

1. At THD = 10%; BTL.

2 W BTL audio amplifier

TDA8543

DC CHARACTERISTICS

$V_{CC} = 5\text{ V}$; $T_{amb} = 25\text{ }^{\circ}\text{C}$; $R_L = 8\text{ }\Omega$; $V_{MODE} = 0\text{ V}$; $G = 20\text{ dB}$; measured in test circuit Fig.4; unless otherwise specified.

SYMBOL	PARAMETER	CONDITIONS	MIN.	TYP.	MAX.	UNIT
V_{CC}	supply voltage	operating	2.2	5	18	V
I_q	quiescent current	$R_L = \infty$; note 1	–	8	12	mA
I_{stb}	standby current	$V_{MODE} = V_{CC}$	–	–	10	μA
V_O	DC output voltage	note 2	–	2.2	–	V
$ V_{OUT+} - V_{OUT-} $	differential output voltage offset		–	–	50	mV
I_{IN+}, I_{IN-}	input bias current		–	–	500	nA
V_{MODE}	input voltage mode select	operating	0	–	0.5	V
		mute	1.5	–	$V_{CC} - 1.5$	V
		standby	$V_{CC} - 0.5$	–	V_{CC}	V
I_{MODE}	input current mode select	$0 < V_{MODE} < V_{CC}$	–	–	20	μA

Notes

1. With a load connected at the outputs the quiescent current will increase, the maximum of this increase being equal to the DC output offset voltage divided by R_L .
2. The DC output voltage with respect to ground is approximately $0.5 \times V_{CC}$.

AC CHARACTERISTICS

$V_{CC} = 5\text{ V}$; $T_{amb} = 25\text{ }^{\circ}\text{C}$; $R_L = 8\text{ }\Omega$; $f = 1\text{ kHz}$; $V_{MODE} = 0\text{ V}$; $G = 20\text{ dB}$; measured in test circuit Fig.4; unless otherwise specified.

SYMBOL	PARAMETER	CONDITIONS	MIN.	TYP.	MAX.	UNIT	
P_o	output power	THD = 10%;					
		$V_{CC} = 5\text{ V}$; $R_L = 8\text{ }\Omega$	1	1.2	–	W	
		$V_{CC} = 7.5\text{ V}$; $R_L = 8\text{ }\Omega$	–	2.2	–	W	
		$V_{CC} = 9\text{ V}$; $R_L = 16\text{ }\Omega$	–	2.0	–	W	
		THD = 0.5%;					
		$V_{CC} = 5\text{ V}$; $R_L = 8\text{ }\Omega$	0.6	0.9	–	W	
	$V_{CC} = 7.5\text{ V}$; $R_L = 8\text{ }\Omega$	–	1.7	–	W		
	$V_{CC} = 9\text{ V}$; $R_L = 16\text{ }\Omega$	–	1.4	–	W		
THD	total harmonic distortion	$P_o = 0.5\text{ W}$	–	0.15	0.3	%	
G_v	closed loop voltage gain	note 1	6	–	30	dB	
Z_i	differential input impedance		–	100	–	k Ω	
V_{no}	noise output voltage	note 2	–	–	100	μV	
SVRR	supply voltage ripple rejection	note 3	50	–	–	dB	
		note 4	40	–	–	dB	
V_o	output voltage in mute condition	note 5	–	–	200	μV	

2 W BTL audio amplifier

TDA8543

Notes to the AC characteristics

1. Gain of the amplifier is $2 \times \frac{R_2}{R_1}$ in test circuit of Fig.4.
2. The noise output voltage is measured at the output in a frequency range from 20 Hz to 20 kHz (unweighted), with a source impedance of $R_S = 0 \Omega$ at the input.
3. Supply voltage ripple rejection is measured at the output, with a source impedance of $R_S = 0 \Omega$ at the input. The ripple voltage is a sine wave with a frequency of 1 kHz and an amplitude of 100 mV (RMS), which is applied to the positive supply rail.
4. Supply voltage ripple rejection is measured at the output, with a source impedance of $R_S = 0 \Omega$ at the input. The ripple voltage is a sine wave with a frequency between 100 Hz and 20 kHz and an amplitude of 100 mV (RMS), which is applied to the positive supply rail.
5. Output voltage in mute position is measured with an input voltage of 1 V (RMS) in a bandwidth of 20 kHz, so including noise.

TEST AND APPLICATION INFORMATION

Test conditions

Because the application can be either Bridge Tied Load (BTL) or Single-Ended (SE), the curves of each application are shown separately.

The thermal resistance = 55 K/W for the DIP16 envelope; the maximum sine wave power dissipation for $T_{amb} = 25^\circ\text{C}$ is:

$$\frac{150 - 25}{55} = 2.27 \text{ W}$$

For $T_{amb} = 60^\circ\text{C}$ the maximum total power dissipation is:

$$\frac{150 - 60}{55} = 1.63 \text{ W}$$

See the power derating curve illustrated in Fig.3.

BTL application

$T_{amb} = 25^\circ\text{C}$ if not specially mentioned, $V_{CC} = 5 \text{ V}$, $f = 1 \text{ kHz}$, $R_L = 8 \Omega$, $G_v = 20 \text{ dB}$, audio band-pass 22 Hz to 22 kHz.

The BTL application diagram is shown in Fig.4.

The quiescent current has been measured without any load impedance. The total harmonic distortion as a function of frequency was measured with a low-pass filter of 80 kHz. The value of capacitor C2 influences the behaviour of the SVRR at low frequencies, increasing the value of C2 increases the performance of the SVRR. The figure of the mode select voltage (V_{ms}) as a function of the supply voltage shows three areas; operating, mute and standby. It shows, that the DC-switching levels of the mute and standby respectively depends on the supply voltage level.

SE application

$T_{amb} = 25^\circ\text{C}$ if not specially mentioned, $V_{CC} = 7.5 \text{ V}$, $f = 1 \text{ kHz}$, $R_L = 4 \Omega$, $G_v = 20 \text{ dB}$, audio band-pass 22 Hz to 22 kHz.

The SE application diagram is shown in Fig.14.

The capacitor value of C3 in combination with the load impedance determines the low frequency behaviour. The total harmonic distortion as a function of frequency was measured with low-pass filter of 80 kHz. The value of capacitor C2 influences the behaviour of the SVRR at low frequencies, increasing the value of C2 increases the performance of the SVRR.

General remark

The frequency characteristic can be adapted by connecting a small capacitor across the feedback resistor. To improve the immunity of HF radiation in radio circuit applications, a small capacitor can be connected in parallel with the feedback resistor; this creates a low-pass filter.

2 W BTL audio amplifier

TDA8543

BTL APPLICATION

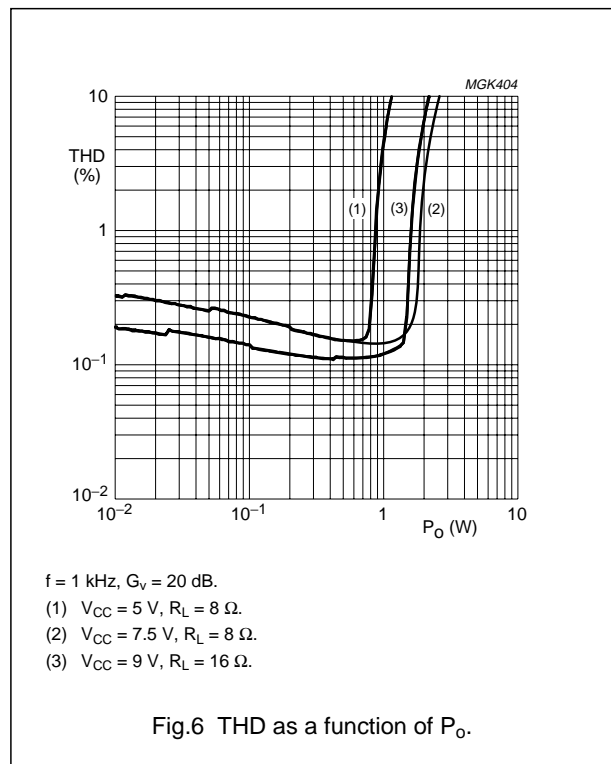
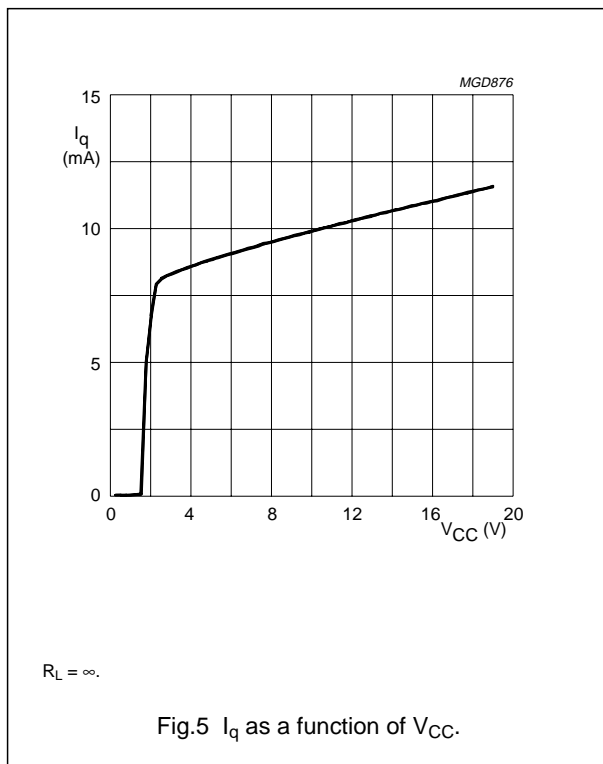
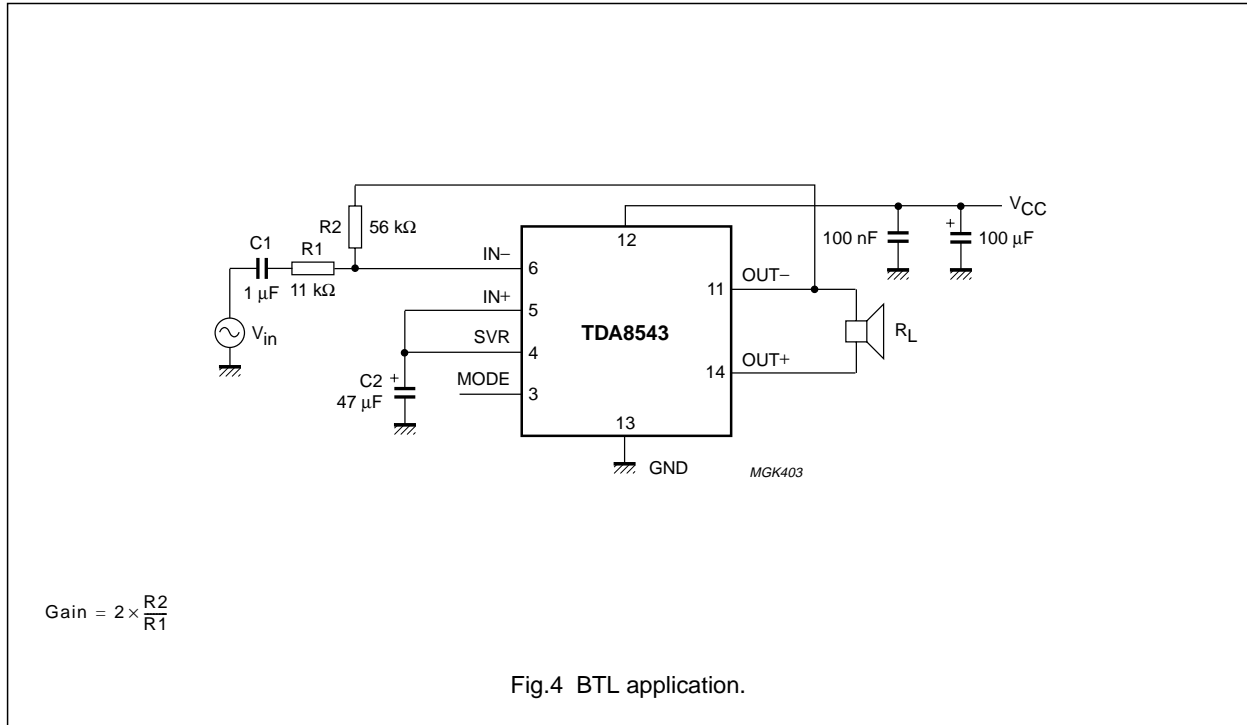

2 W BTL audio amplifier

TDA8543

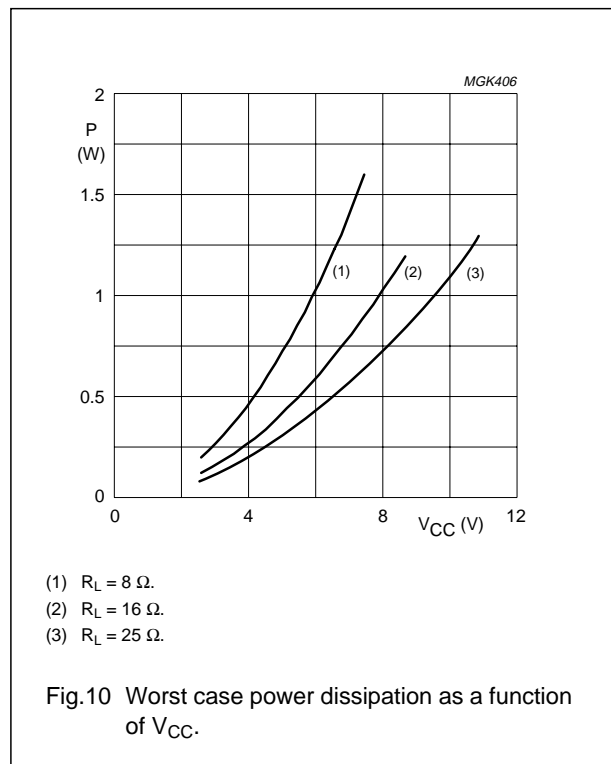
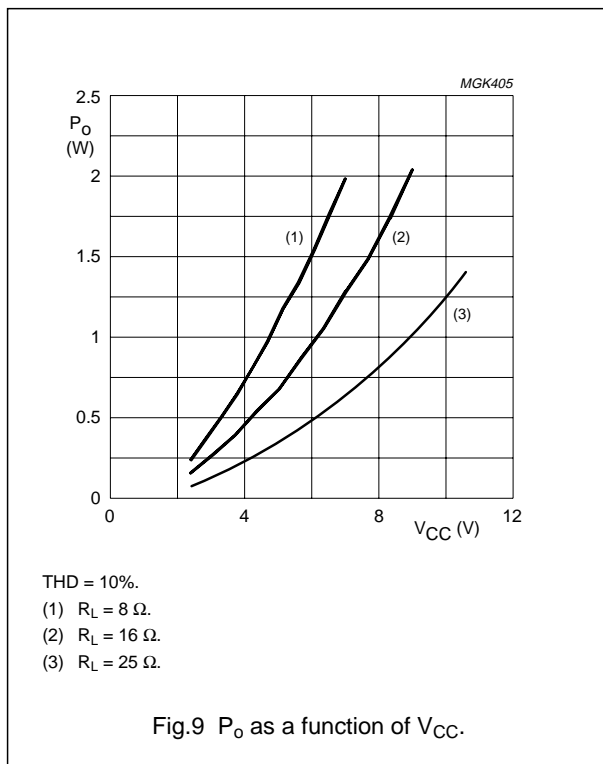
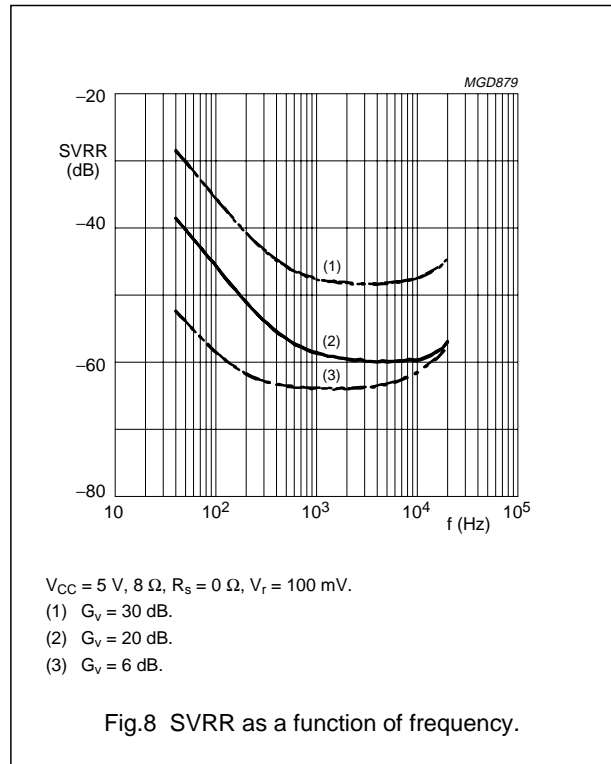
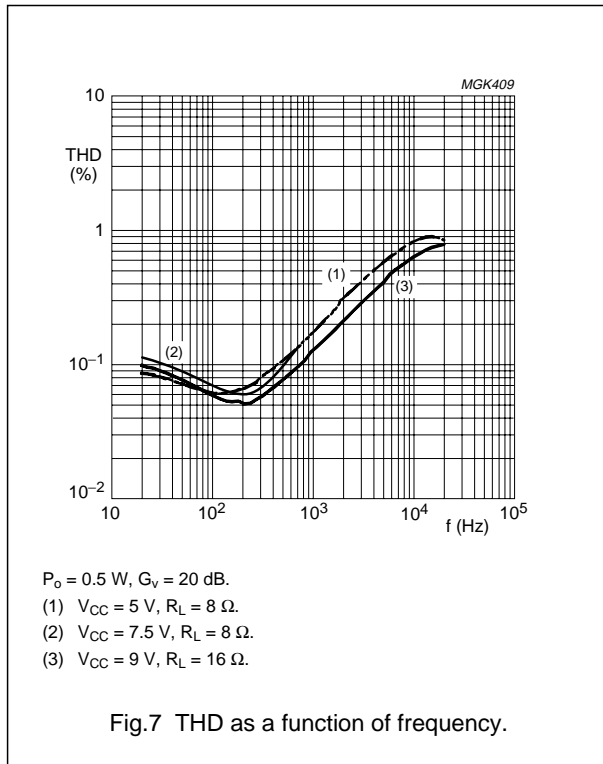

2 W BTL audio amplifier

TDA8543

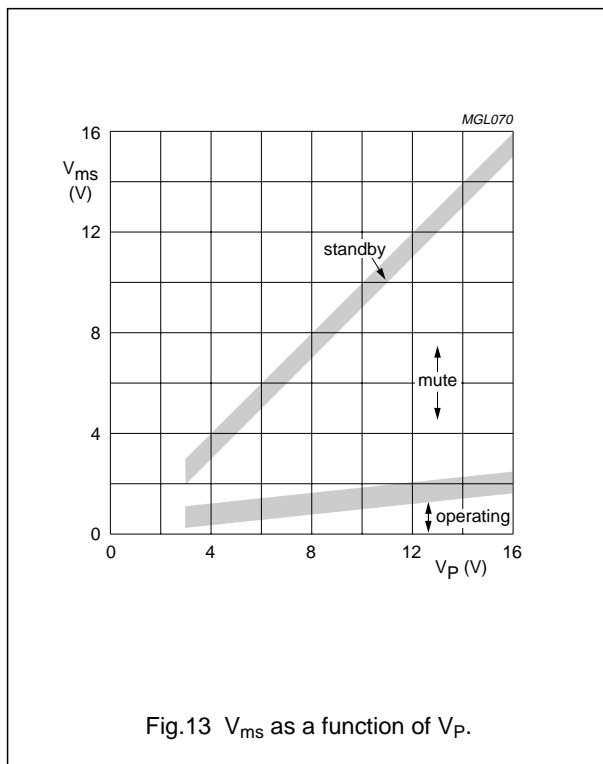
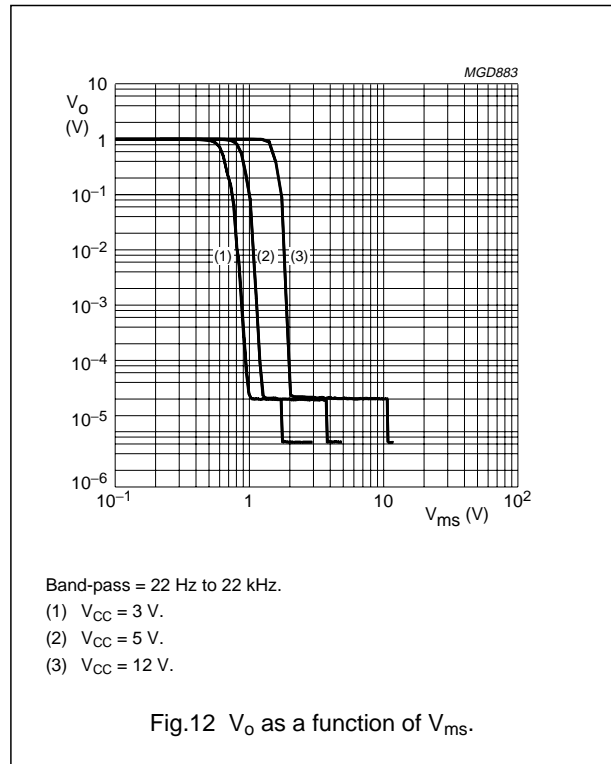
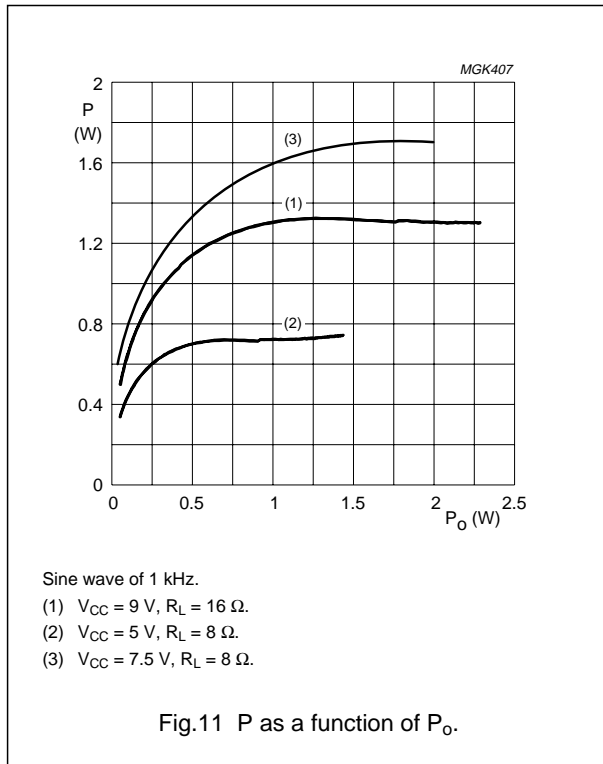

2 W BTL audio amplifier

TDA8543

SE APPLICATION

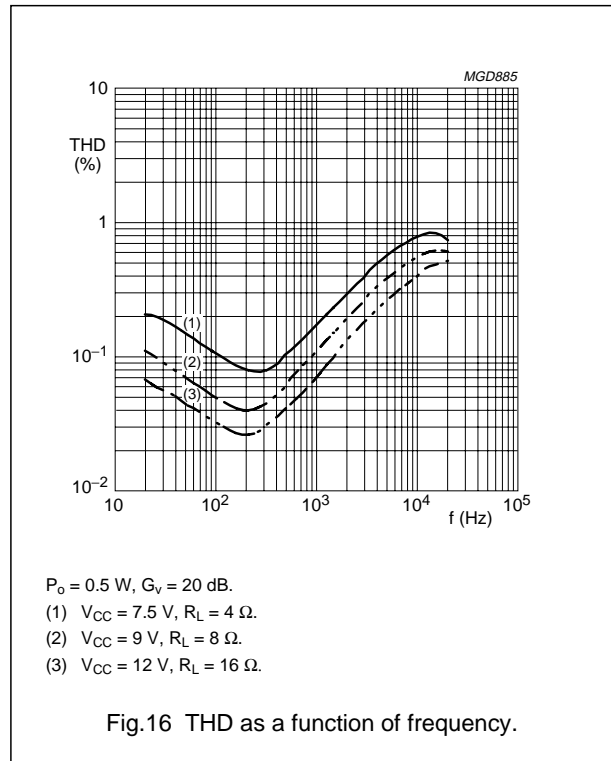
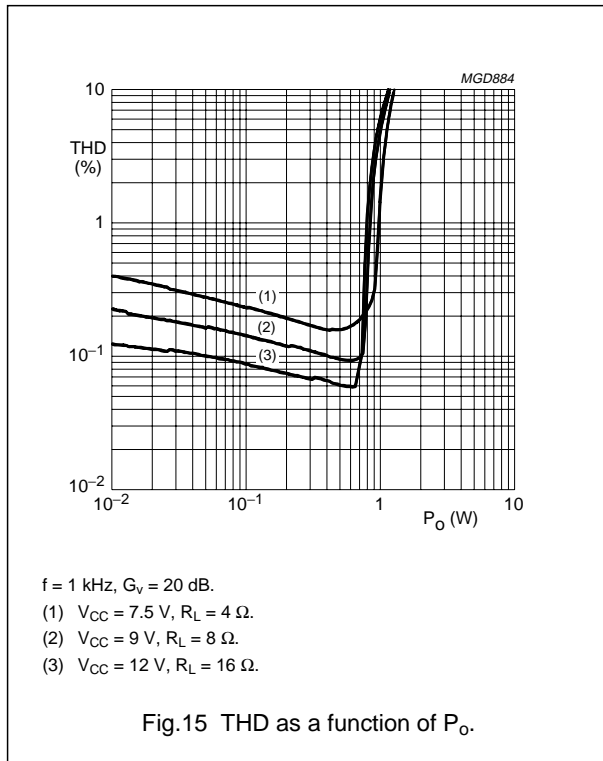
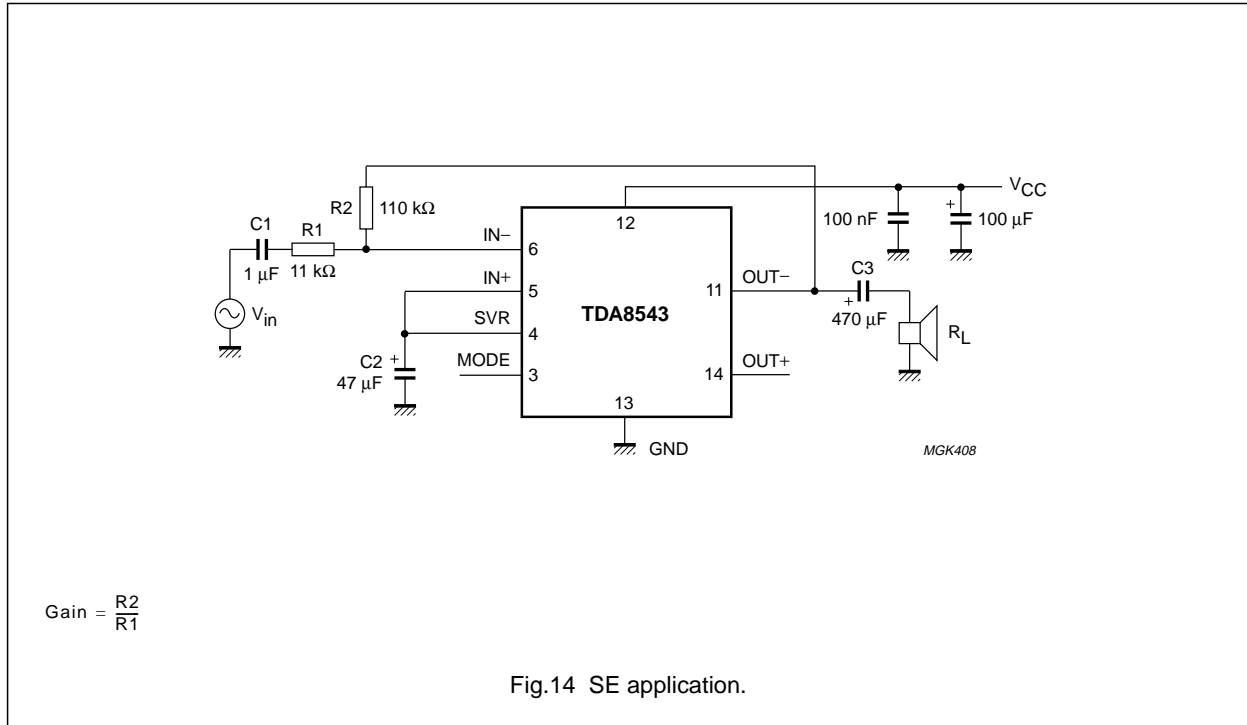

2 W BTL audio amplifier

TDA8543

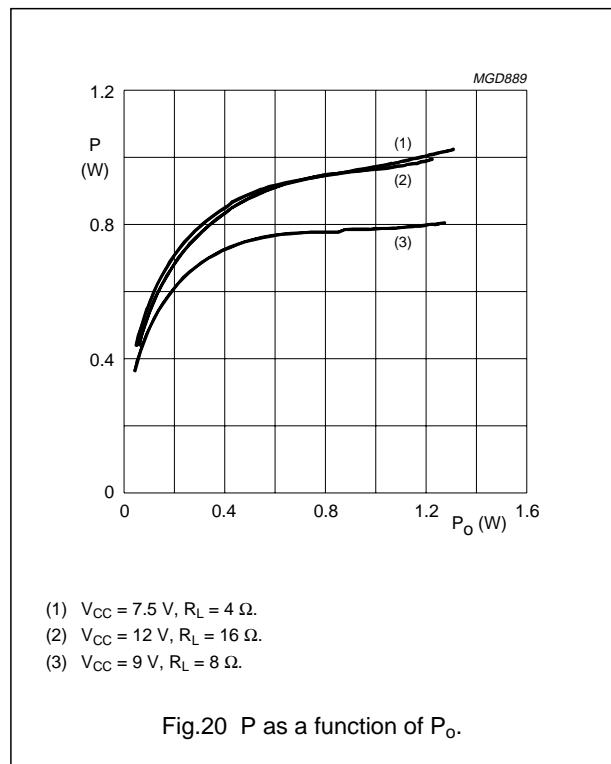
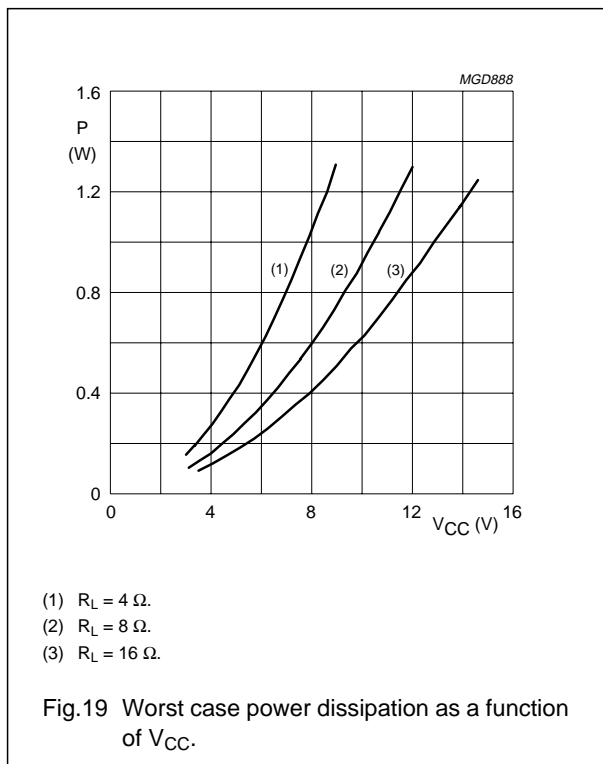
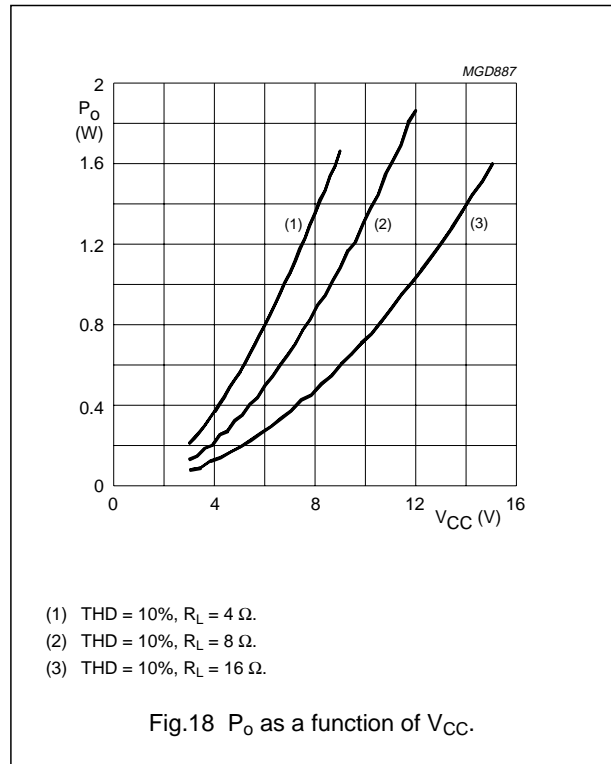
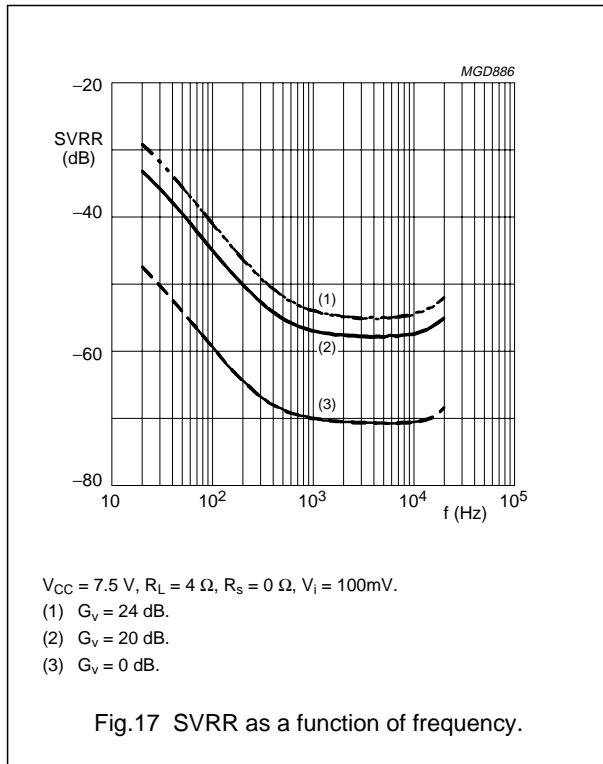

2 W BTL audio amplifier

TDA8543

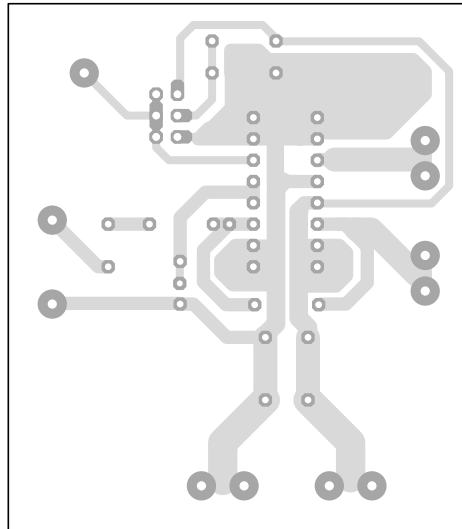

a. Top view.

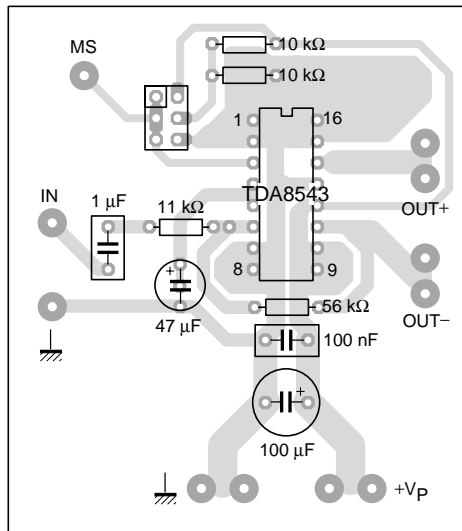

MGK411

b. Component side.

Fig.21 Printed-circuit board layout (BTL and SE).

2 W BTL audio amplifier

TDA8543

PACKAGE OUTLINES

DIP16: plastic dual in-line package; 16 leads (300 mil); long body

SOT38-1

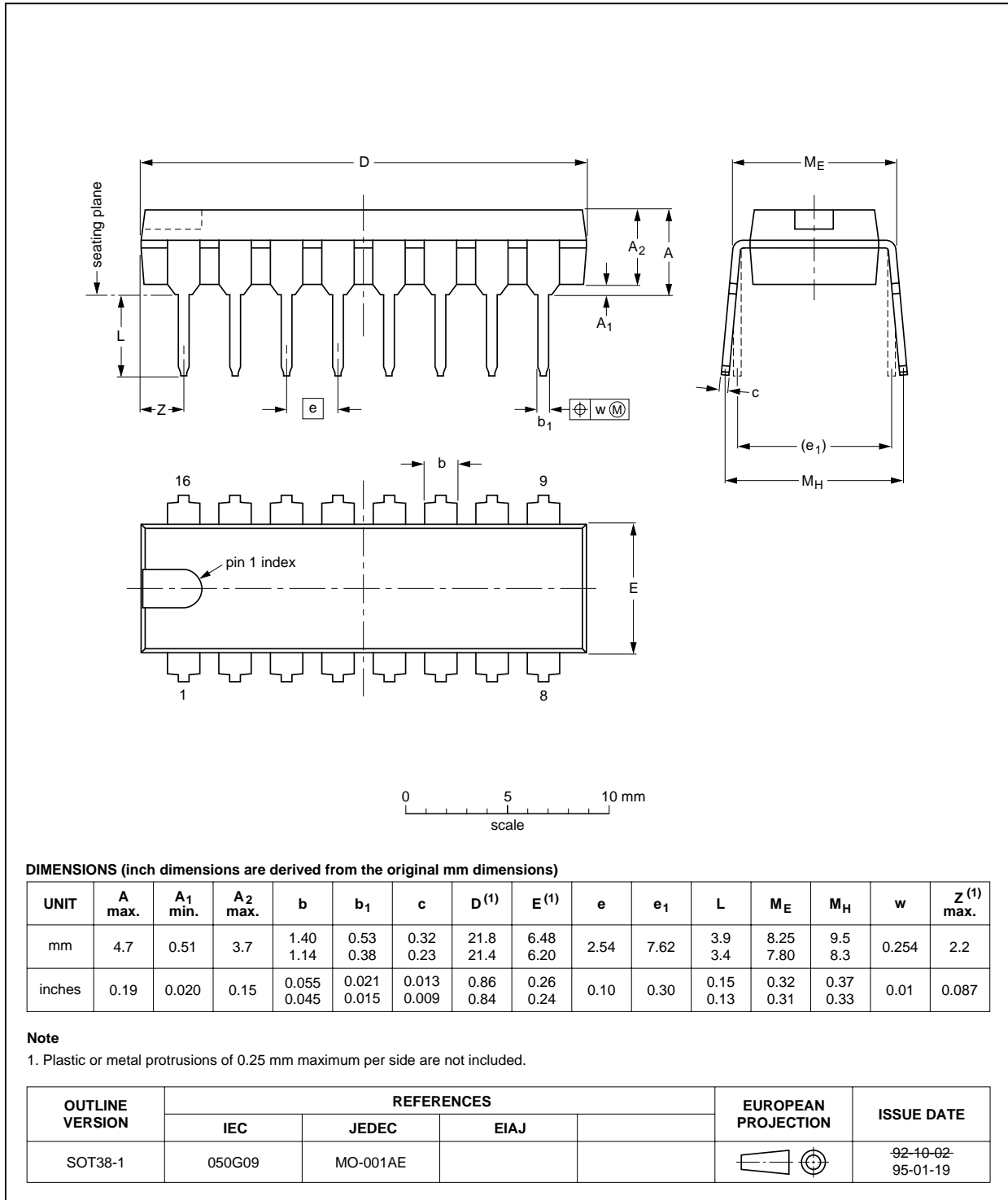

2 W BTL audio amplifier

TDA8543

SO16: plastic small outline package; 16 leads; body width 3.9 mm

SOT109-1

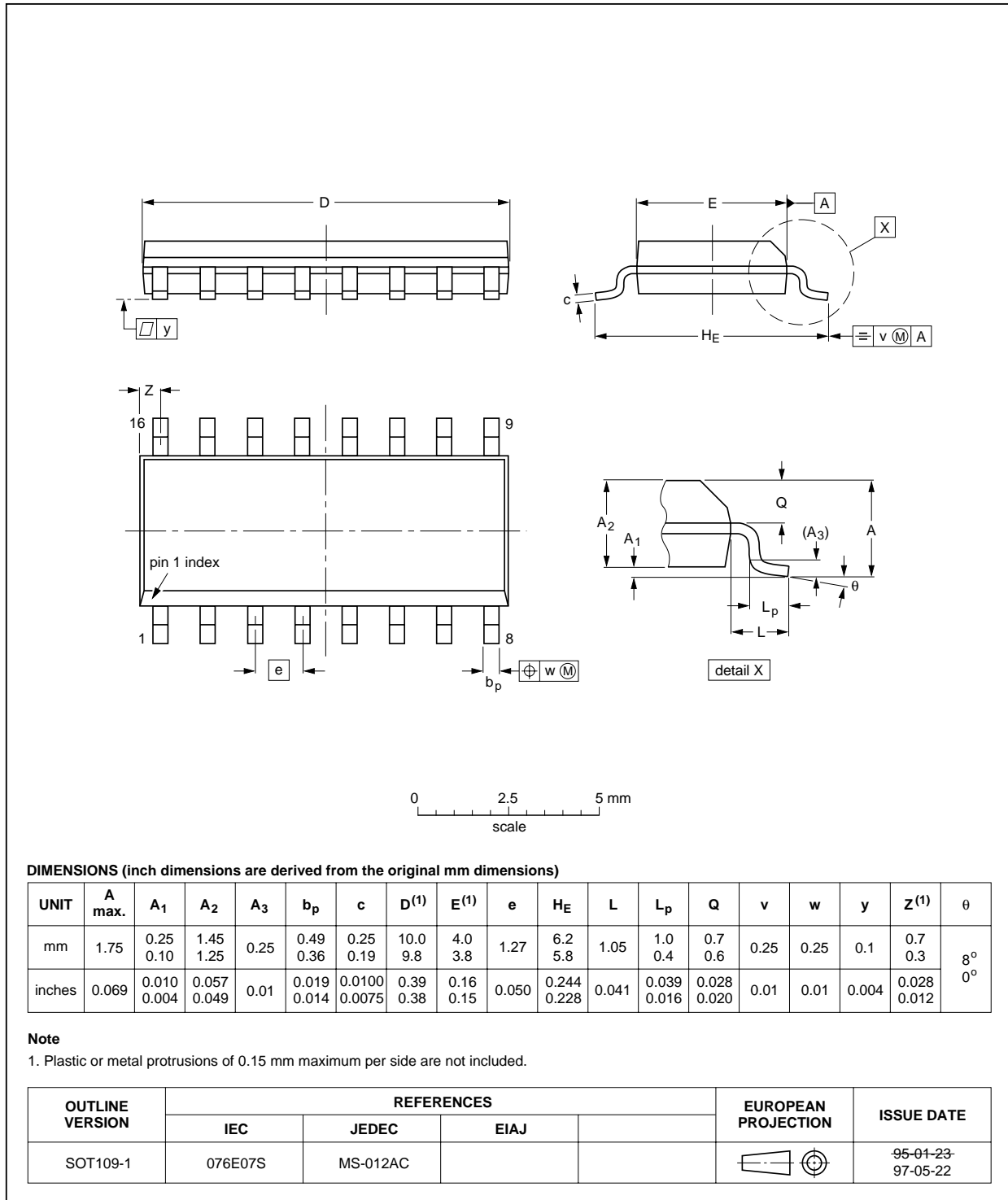

2 W BTL audio amplifier

TDA8543

SOLDERING

Introduction

There is no soldering method that is ideal for all IC packages. Wave soldering is often preferred when through-hole and surface mounted components are mixed on one printed-circuit board. However, wave soldering is not always suitable for surface mounted ICs, or for printed-circuits with high population densities. In these situations reflow soldering is often used.

This text gives a very brief insight to a complex technology. A more in-depth account of soldering ICs can be found in our *"IC Package Databook"* (order code 9398 652 90011).

DIP

SOLDERING BY DIPPING OR BY WAVE

The maximum permissible temperature of the solder is 260 °C; solder at this temperature must not be in contact with the joint for more than 5 seconds. The total contact time of successive solder waves must not exceed 5 seconds.

The device may be mounted up to the seating plane, but the temperature of the plastic body must not exceed the specified maximum storage temperature ($T_{stg\ max}$). If the printed-circuit board has been pre-heated, forced cooling may be necessary immediately after soldering to keep the temperature within the permissible limit.

REPAIRING SOLDERED JOINTS

Apply a low voltage soldering iron (less than 24 V) to the lead(s) of the package, below the seating plane or not more than 2 mm above it. If the temperature of the soldering iron bit is less than 300 °C it may remain in contact for up to 10 seconds. If the bit temperature is between 300 and 400 °C, contact may be up to 5 seconds.

SO

REFLOW SOLDERING

Reflow soldering techniques are suitable for all SO packages.

Reflow soldering requires solder paste (a suspension of fine solder particles, flux and binding agent) to be applied

to the printed-circuit board by screen printing, stencilling or pressure-syringe dispensing before package placement.

Several techniques exist for reflowing; for example, thermal conduction by heated belt. Dwell times vary between 50 and 300 seconds depending on heating method. Typical reflow temperatures range from 215 to 250 °C.

Preheating is necessary to dry the paste and evaporate the binding agent. Preheating duration: 45 minutes at 45 °C.

WAVE SOLDERING

Wave soldering techniques can be used for all SO packages if the following conditions are observed:

- A double-wave (a turbulent wave with high upward pressure followed by a smooth laminar wave) soldering technique should be used.
- The longitudinal axis of the package footprint must be parallel to the solder flow.
- The package footprint must incorporate solder thieves at the downstream end.

During placement and before soldering, the package must be fixed with a droplet of adhesive. The adhesive can be applied by screen printing, pin transfer or syringe dispensing. The package can be soldered after the adhesive is cured.

Maximum permissible solder temperature is 260 °C, and maximum duration of package immersion in solder is 10 seconds, if cooled to less than 150 °C within 6 seconds. Typical dwell time is 4 seconds at 250 °C.

A mildly-activated flux will eliminate the need for removal of corrosive residues in most applications.

REPAIRING SOLDERED JOINTS

Fix the component by first soldering two diagonally-opposite end leads. Use only a low voltage soldering iron (less than 24 V) applied to the flat part of the lead. Contact time must be limited to 10 seconds at up to 300 °C. When using a dedicated tool, all other leads can be soldered in one operation within 2 to 5 seconds between 270 and 320 °C.

2 W BTL audio amplifier

TDA8543

DEFINITIONS

Data sheet status	
Objective specification	This data sheet contains target or goal specifications for product development.
Preliminary specification	This data sheet contains preliminary data; supplementary data may be published later.
Product specification	This data sheet contains final product specifications.
Limiting values	
Limiting values given are in accordance with the Absolute Maximum Rating System (IEC 134). Stress above one or more of the limiting values may cause permanent damage to the device. These are stress ratings only and operation of the device at these or at any other conditions above those given in the Characteristics sections of the specification is not implied. Exposure to limiting values for extended periods may affect device reliability.	
Application information	
Where application information is given, it is advisory and does not form part of the specification.	

LIFE SUPPORT APPLICATIONS

These products are not designed for use in life support appliances, devices, or systems where malfunction of these products can reasonably be expected to result in personal injury. Philips customers using or selling these products for use in such applications do so at their own risk and agree to fully indemnify Philips for any damages resulting from such improper use or sale.

2 W BTL audio amplifier

TDA8543

NOTES

2 W BTL audio amplifier

TDA8543

NOTES

Philips Semiconductors – a worldwide company

Argentina: see South America

Australia: 34 Waterloo Road, NORTH RYDE, NSW 2113,
Tel. +61 2 9805 4455, Fax. +61 2 9805 4466

Austria: Computerstr. 6, A-1101 WIEN, P.O. Box 213,
Tel. +43 1 60 101, Fax. +43 1 60 101 1210

Belarus: Hotel Minsk Business Center, Bld. 3, r. 1211, Volodarski Str. 6,
220050 MINSK, Tel. +375 172 200 733, Fax. +375 172 200 773

Belgium: see The Netherlands

Brazil: see South America

Bulgaria: Philips Bulgaria Ltd., Energoproject, 15th floor,
51 James Bourchier Blvd., 1407 SOFIA,
Tel. +359 2 689 211, Fax. +359 2 689 102

Canada: PHILIPS SEMICONDUCTORS/COMPONENTS,
Tel. +1 800 234 7381

China/Hong Kong: 501 Hong Kong Industrial Technology Centre,
72 Tat Chee Avenue, Kowloon Tong, HONG KONG,
Tel. +852 2319 7888, Fax. +852 2319 7700

Colombia: see South America

Czech Republic: see Austria

Denmark: Prags Boulevard 80, PB 1919, DK-2300 COPENHAGEN S,
Tel. +45 32 88 2636, Fax. +45 31 57 1949

Finland: Sinikalliontie 3, FIN-02630 ESPOO,
Tel. +358 9 615800, Fax. +358 9 61580/xxx

France: 4 Rue du Port-aux-Vins, BP317, 92156 SURESNES Cedex,
Tel. +33 1 40 99 6161, Fax. +33 1 40 99 6427

Germany: Hammerbrookstraße 69, D-20097 HAMBURG,
Tel. +49 40 23 53 60, Fax. +49 40 23 536 300

Greece: No. 15, 25th March Street, GR 17778 TAVROS/ATHENS,
Tel. +30 1 4894 339/239, Fax. +30 1 4814 240

Hungary: see Austria

India: Philips INDIA Ltd, Shivsagar Estate, A Block, Dr. Annie Besant Rd.
Worli, MUMBAI 400 018, Tel. +91 22 4938 541, Fax. +91 22 4938 722

Indonesia: see Singapore

Ireland: Newstead, Clonskeagh, DUBLIN 14,
Tel. +353 1 7640 000, Fax. +353 1 7640 200

Israel: RAPAC Electronics, 7 Kehilat Saloniki St, TEL AVIV 61180,
Tel. +972 3 645 0444, Fax. +972 3 649 1007

Italy: PHILIPS SEMICONDUCTORS, Piazza IV Novembre 3,
20124 MILANO, Tel. +39 2 6752 2531, Fax. +39 2 6752 2557

Japan: Philips Bldg 13-37, Kohnan 2-chome, Minato-ku, TOKYO 108,
Tel. +81 3 3740 5130, Fax. +81 3 3740 5077

Korea: Philips House, 260-199 Itaewon-dong, Yongsan-ku, SEOUL,
Tel. +82 2 709 1412, Fax. +82 2 709 1415

Malaysia: No. 76 Jalan Universiti, 46200 PETALING JAYA, SELANGOR,
Tel. +60 3 750 5214, Fax. +60 3 757 4880

Mexico: 5900 Gateway East, Suite 200, EL PASO, TEXAS 79905,
Tel. +9-5 800 234 7381

Middle East: see Italy

Netherlands: Postbus 90050, 5600 PB EINDHOVEN, Bldg. VB,
Tel. +31 40 27 82785, Fax. +31 40 27 88399

New Zealand: 2 Wagener Place, C.P.O. Box 1041, AUCKLAND,
Tel. +64 9 849 4160, Fax. +64 9 849 7811

Norway: Box 1, Manglerud 0612, OSLO,
Tel. +47 22 74 8000, Fax. +47 22 74 8341

Philippines: Philips Semiconductors Philippines Inc.,
106 Valero St. Salcedo Village, P.O. Box 2108 MCC, MAKATI,
Metro MANILA, Tel. +63 2 816 6380, Fax. +63 2 817 3474

Poland: Ul. Lukiska 10, PL 04-123 WARSZAWA,
Tel. +48 22 612 2831, Fax. +48 22 612 2327

Portugal: see Spain

Romania: see Italy

Russia: Philips Russia, Ul. Usatcheva 35A, 119048 MOSCOW,
Tel. +7 095 755 6918, Fax. +7 095 755 6919

Singapore: Lorong 1, Toa Payoh, SINGAPORE 1231,
Tel. +65 350 2538, Fax. +65 251 6500

Slovakia: see Austria

Slovenia: see Italy

South Africa: S.A. PHILIPS Pty Ltd., 195-215 Main Road Martindale,
2092 JOHANNESBURG, P.O. Box 7430 Johannesburg 2000,
Tel. +27 11 470 5911, Fax. +27 11 470 5494

South America: Rua do Rocio 220, 5th floor, Suite 51,
04552-903 São Paulo, SÃO PAULO - SP, Brazil,
Tel. +55 11 821 2333, Fax. +55 11 829 1849

Spain: Balmes 22, 08007 BARCELONA,
Tel. +34 3 301 6312, Fax. +34 3 301 4107

Sweden: Kottbygatan 7, Akalla, S-16485 STOCKHOLM,
Tel. +46 8 632 2000, Fax. +46 8 632 2745

Switzerland: Allmendstrasse 140, CH-8027 ZÜRICH,
Tel. +41 1 488 2686, Fax. +41 1 481 7730

Taiwan: Philips Semiconductors, 6F, No. 96, Chien Kuo N. Rd., Sec. 1,
TAIPEI, Taiwan Tel. +886 2 2134 2870, Fax. +886 2 2134 2874

Thailand: PHILIPS ELECTRONICS (THAILAND) Ltd.,
209/2 Sanpavuth-Bangna Road Prakanong, BANGKOK 10260,
Tel. +66 2 745 4090, Fax. +66 2 398 0793

Turkey: Talatpasa Cad. No. 5, 80640 GÜLTEPE/ISTANBUL,
Tel. +90 212 279 2770, Fax. +90 212 282 6707

Ukraine: PHILIPS UKRAINE, 4 Patrice Lumumba str., Building B, Floor 7,
252042 KIEV, Tel. +380 44 264 2776, Fax. +380 44 268 0461

United Kingdom: Philips Semiconductors Ltd., 276 Bath Road, Hayes,
MIDDLESEX UB3 5BX, Tel. +44 181 730 5000, Fax. +44 181 754 8421

United States: 811 East Arques Avenue, SUNNYVALE, CA 94088-3409,
Tel. +1 800 234 7381

Uruguay: see South America

Vietnam: see Singapore

Yugoslavia: PHILIPS, Trg N. Pasica 5/v, 11000 BEOGRAD,
Tel. +381 11 625 344, Fax. +381 11 635 777

For all other countries apply to: Philips Semiconductors, Marketing & Sales Communications,
Building BE-p, P.O. Box 218, 5600 MD EINDHOVEN, The Netherlands, Fax. +31 40 27 24825

Internet: <http://www.semiconductors.philips.com>

© Philips Electronics N.V. 1997

SCA53

All rights are reserved. Reproduction in whole or in part is prohibited without the prior written consent of the copyright owner.

The information presented in this document does not form part of any quotation or contract, is believed to be accurate and reliable and may be changed without notice. No liability will be accepted by the publisher for any consequence of its use. Publication thereof does not convey nor imply any license under patent- or other industrial or intellectual property rights.

Printed in The Netherlands

547027/50/01/pp20

Date of release: 1997 Jun 12

Document order number: 9397 750 02232

Let's make things better.

**Philips
Semiconductors**



PHILIPS