

LOW NOISE PREAMPLIFIER COMPRESSOR

- SINGLE SUPPLY OPERATION (10 to 30V)
- HIGH SUPPLY VOLTAGE REJECTION
- COMPRESSOR FACILITY
- VERY LOW NOISE AND DISTORTION
- HIGH COMMON MODE REJECTION
- SHORT CIRCUIT PROTECTION

DESCRIPTION

The TDA 7232 is a preamplifier mainly intended for car-radio applications, requiring very low noise and distortion performance.

It consists of a unity gain differential input amplifier with a very high common mode rejection, a compressor which avoids the output clipping and three multipurpose operational amplifiers.

A high stability voltage regulator is also included. The TDA 7232 is assembled in a 20 lead dual in line plastic package.

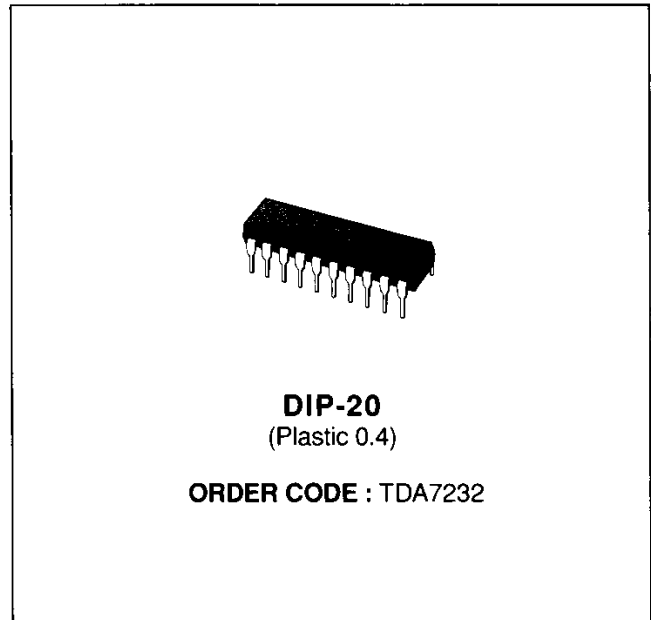

PIN CONNECTION (top view)

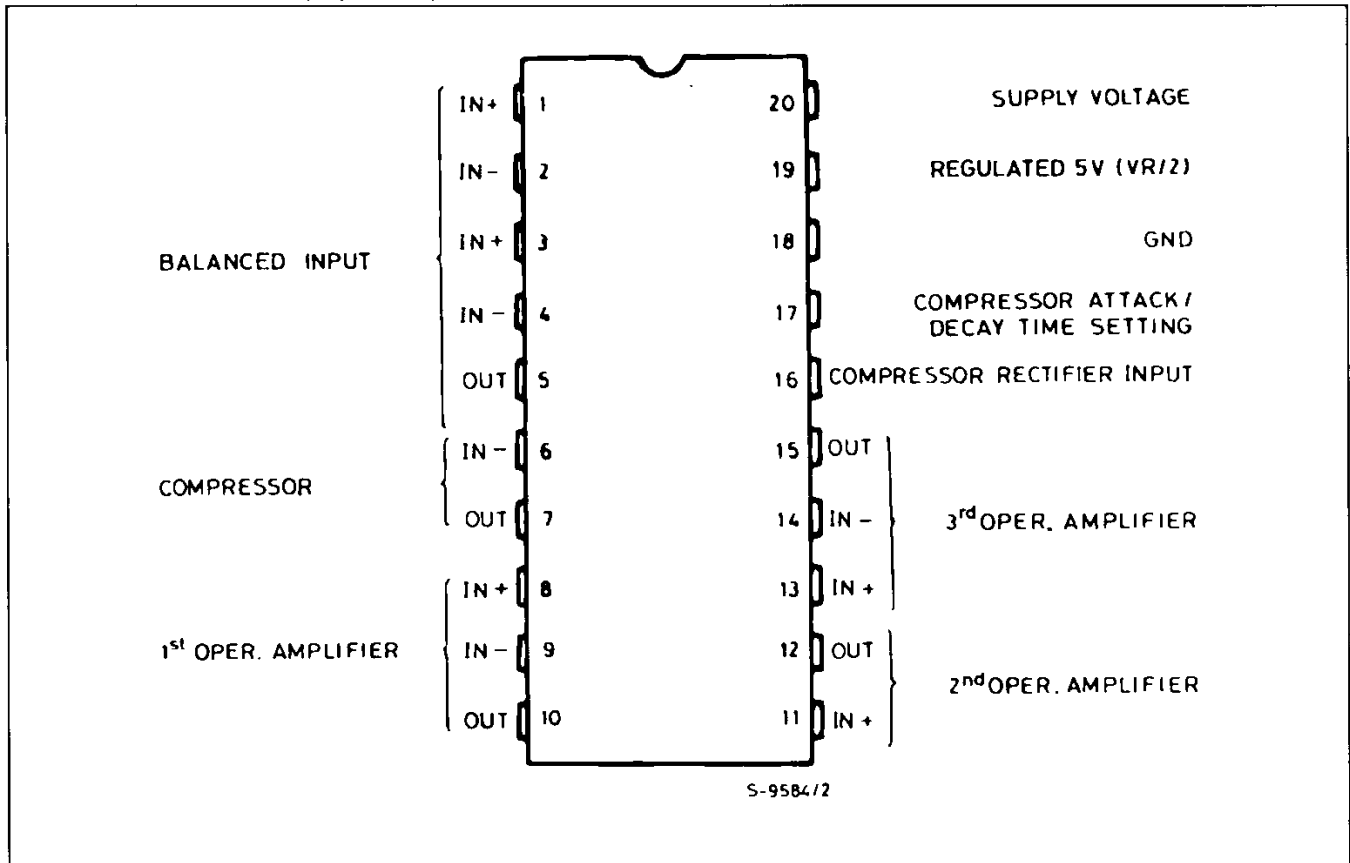

BLOCK DIAGRAM

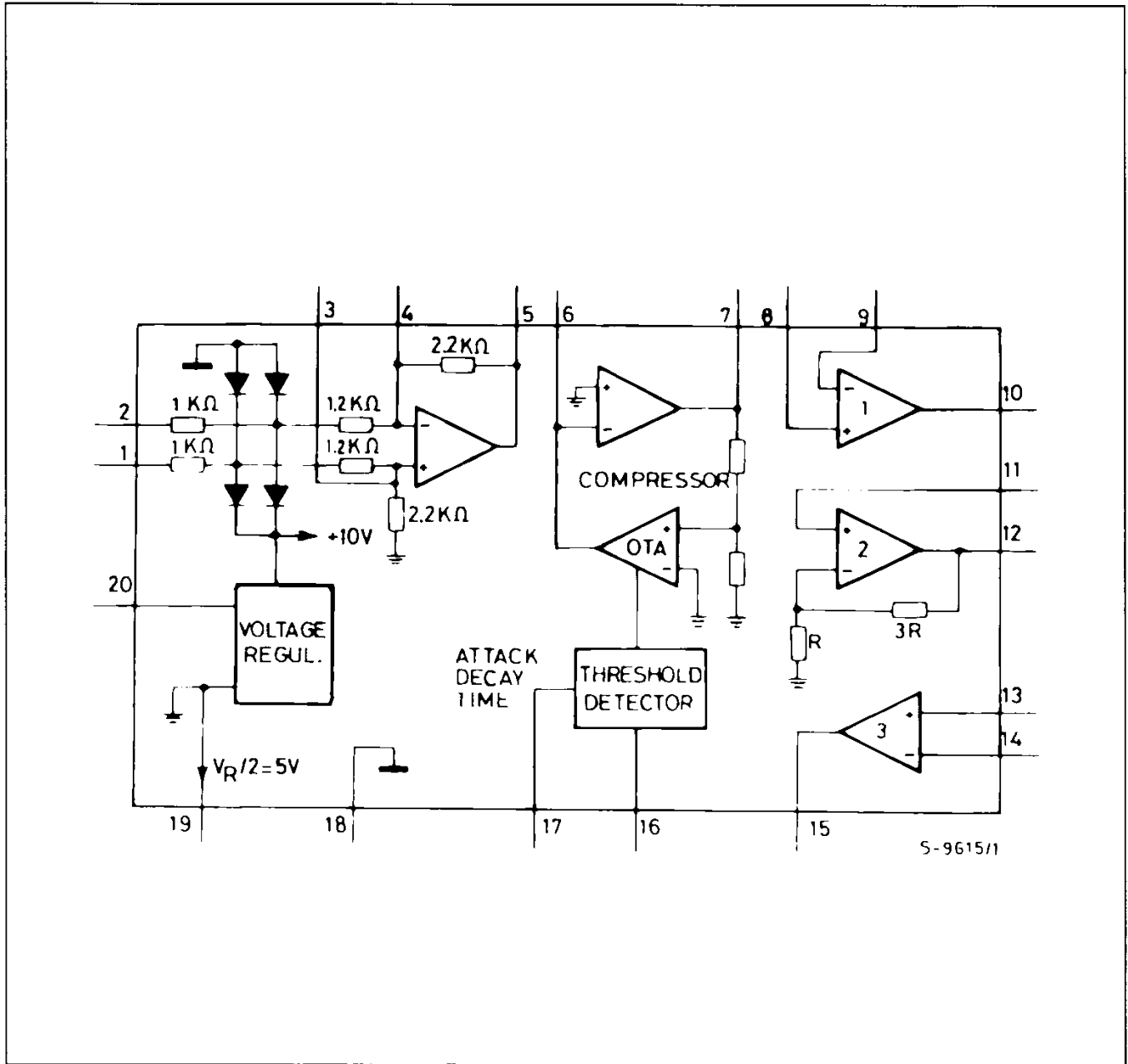

ABSOLUTE MAXIMUM RATINGS

Symbol	Parameter	Value	Unit
V_s	Operating Supply Voltage	30	V
V_s	Peak Supply Voltage (for 50 ms)	40	V
V_i	Input Voltage	$\pm V_s$	
T_{op}	Operating Temperature	- 25 to 85	$^{\circ}C$
P_{tot}	Total Power Dissipation at $T_{amb} = 70^{\circ}C$	1	W

THERMAL DATA

$R_{thj-amb}$	Thermal Resistance Junction-ambient	Max	80	$^{\circ}C/W$
---------------	-------------------------------------	-----	----	---------------

ELECTRICAL CHARACTERISTICS ($T_{amb} = 25\text{ }^{\circ}\text{C}$, $V_s = 14.4\text{ V}$, $G_v = 30\text{ dB}$, refer to test circuit amplifier fig. 1)

Symbol	Parameter	Test Conditions	Min.	Typ.	Max.	Unit
V_s	Supply Voltage		10		30	V
I_s	Supply Current			10	16	mA
G_v	Closed Loop Gain	Pin 1–2 to Pin 15	29	30	31	dB
d	Total Harmonic Distortion	f = 1 KHz out of Compression $V_o = 2\text{ V}_{RMS}$		0.03	0.12	%
		in compression $V_i = 0.7\text{ V}_{RMS}$		0.15	0.5	%
V_o	Output Volt. Swing		7.5	8.4		V
e_N	Total Output Noise	$R_g = 50\ \Omega$		160		μV
		B = 22 Hz to 22 KHz Curve A		120		μV
SVR	Supply Volt. Rejection (*)	$R_g = 50\ \Omega$ $V_R = 1\text{ V}_{RMS}$ f = 100 Hz	90	110		dB

INPUT DIFFERENTIAL AMPLIFIER

Symbol	Parameter	Test Conditions	Min.	Typ.	Max.	Unit
V_{OS}	Input Offset Voltage			1	7	mV
G_v	Voltage Gain	f = 20 Hz to 20 KHz	0.98	1	1.02	V/V
e_N	Total Input Noise Voltage	$R_g = 50\ \Omega$; B = 22 Hz to 22 KHz		1.5		μV
		$R_g = 50\ \Omega$; Curve A		1.1		μV
d	Distortion	$R_L = 2\text{ K}\Omega$ f = 1 KHz $V_o = 1\text{ V}_{RMS}$		0.01		%
V_o	Output Swing	$R_L = 2\text{ K}\Omega$	7.5	8.4		V_{pp}
SR	Slew Rate			1		$\text{V}/\mu\text{S}$
CMR	Common Mode Reject.	f = 20 Hz to 20 KHz	36	50		dB

COMPRESSOR

Symbol	Parameter	Test Conditions	Min.	Typ.	Max.	Unit
I_b	Input Bias Current			60	300	nA
V_{OS}	Input Offset Voltage	$R_g \leq 10\text{ K}\Omega$ out of Compression		1	3.5	mV
V_{OS}	Output Offset Voltage	in Compression $V_{pin.17} = 0.7\text{ V}$			350	mV
e_N	Total Input Noise Voltage	$R_g = 50\ \Omega$; B = 22 Hz to 22 KHz		1.8		μV
		$R_g = 50\ \Omega$; Curve A		1.3		μV
d	Distortion	$R_L = 2\text{ K}\Omega$ f = 1 KHz $V_o = 1\text{ V}_{RMS}$ $G_v = 20\text{ dB}$		0.01		%
SVR	Supply Voltage Rejection	$V_R = 1\text{ V}$, f = 100 Hz, $R_g = 50\ \Omega$	86			dB

(*) Referred to the input.

ELECTRICAL CHARACTERISTICS (continued)

Symbol	Parameter	Test Conditions	Min.	Typ.	Max.	Unit
V_o	DC Output Voltage Swing	$R_L = 2\text{ K}\Omega$	7.5	8.4		V
SR	Slew Rate			0.7		V/ μ S

1st AND 3rd OPERATION AMPLIFIER

Symbol	Parameter	Test Conditions	Min.	Typ.	Max.	Unit
I_b	Input Bias Current			60	300	nA
I_{os}	Input Offset Current			20	50	nA
V_{os}	Input Offset Voltage	$R_g \leq 10\text{ K}\Omega$		1	3.5	mV
CMR	Common Mode Rejection		86			dB
SVR	Supply Voltage Rejection	$V_R = 1\text{ V}$, $f = 100\text{ Hz}$, $R_g = 50\ \Omega$	86			dB
e_N	Total Input Noise Voltage	$R_g = 50\ \Omega$; B = 22 Hz to 22 KHz		1.4		μ V
		$R_g = 50\ \Omega$; Curve A		1.1		μ V
V_o	Output Voltage Swing	$R_L = 2\text{ K}\Omega$	7.5	8.4		V_{pp}
d	Total Harmonic Distortion	$R_L = 2\text{ K}\Omega$ $f = 1\text{ KHz}$ $V_o = 1\text{ V}_{RMS}$ $G_v = 20\text{ dB}$		0.01		%
G_v	Open Loop Gain	$R_L = 2\text{ K}\Omega$	86	100		dB
SR	Slew Rate	$R_L = 2\text{ K}\Omega$		1		V/ μ S

2nd OPERATIONAL AMPLIFIER ($G_v = 12\text{ dB}$ internally set)

Symbol	Parameter	Test Conditions	Min.	Typ.	Max.	Unit
V_{os}	Output Offset Voltage			4	15	mV
SVR	Supply Voltage Rejection	$V_R = 1\text{ V}$ $f = 100\text{ Hz}$	86			dB
e_N	Total Input Noise Voltage	$R_g = 50\ \Omega$; B = 22 Hz to 22 KHz		2.2		μ V
		$R_g = 50\ \Omega$; Curve A		1.4		μ V
V_o	DC Output Voltage Swing	$R_L = 2\text{ K}\Omega$	7.5	8.4		V
d	Total Harmonic Distortion	$R_L = 2\text{ K}\Omega$, $f = 1\text{ KHz}$ $V_o = 1\text{ V}_{RMS}$		0.01		%
G_v	Voltage Gain	$f = 20\text{ Hz to }20\text{ KHz}$	11.5	12	12.5	dB
SR	Slew Rate	$R_L = 2\text{ K}\Omega$		1		V/ μ s

VOLTAGE REGULATOR

Symbol	Parameter	Test Conditions	Min.	Typ.	Max.	Unit
V_o	Output Voltage	Pin 19 $I_{sink, source}$ from 0 to 12 mA	4.6	5	5.4	V
I_o	Output Max. Current	I_{source}		12		mA
		I_{sink}		12		mA

Figure 1 : Test Circuit.

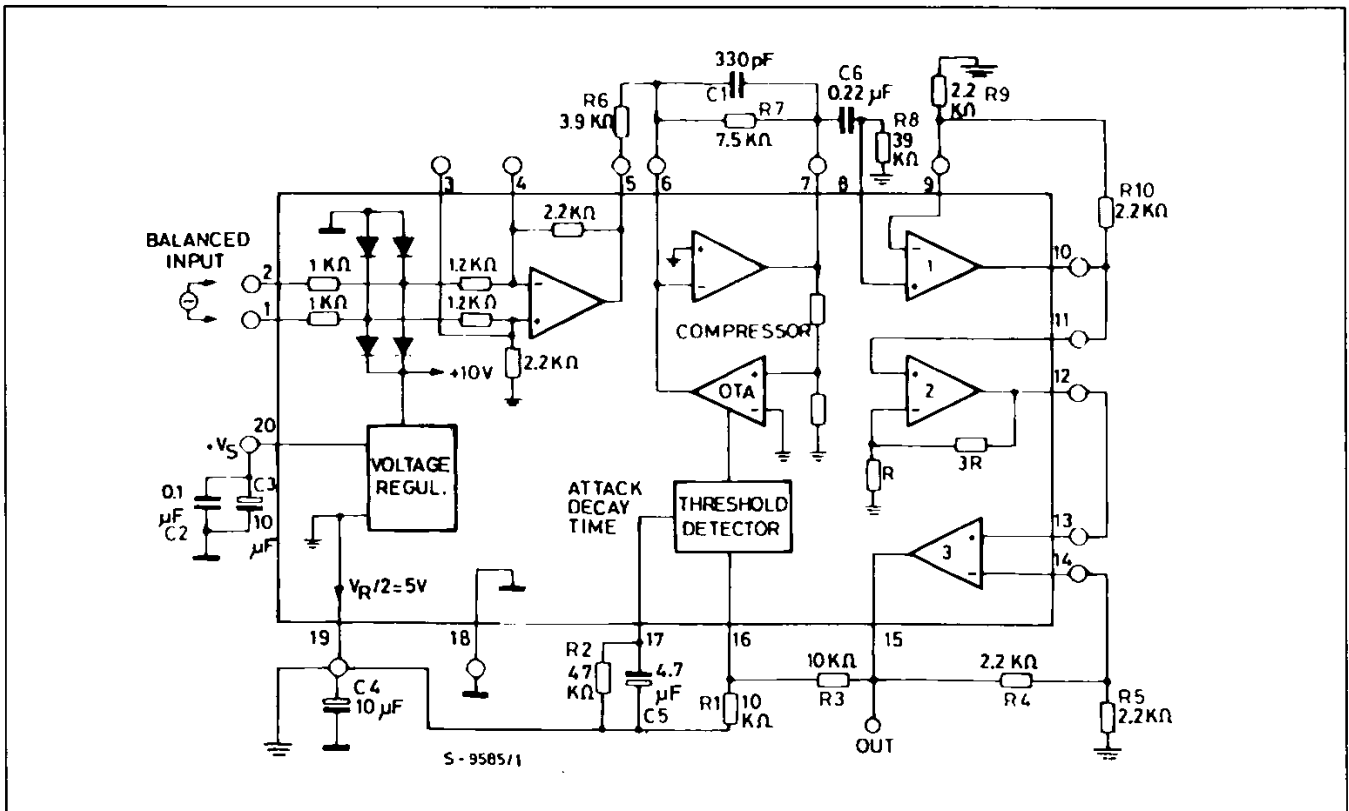

Figure 2 : P.C. Board and Components Layout of the Test Circuit of Fig. 1 (1 : 1 scale).

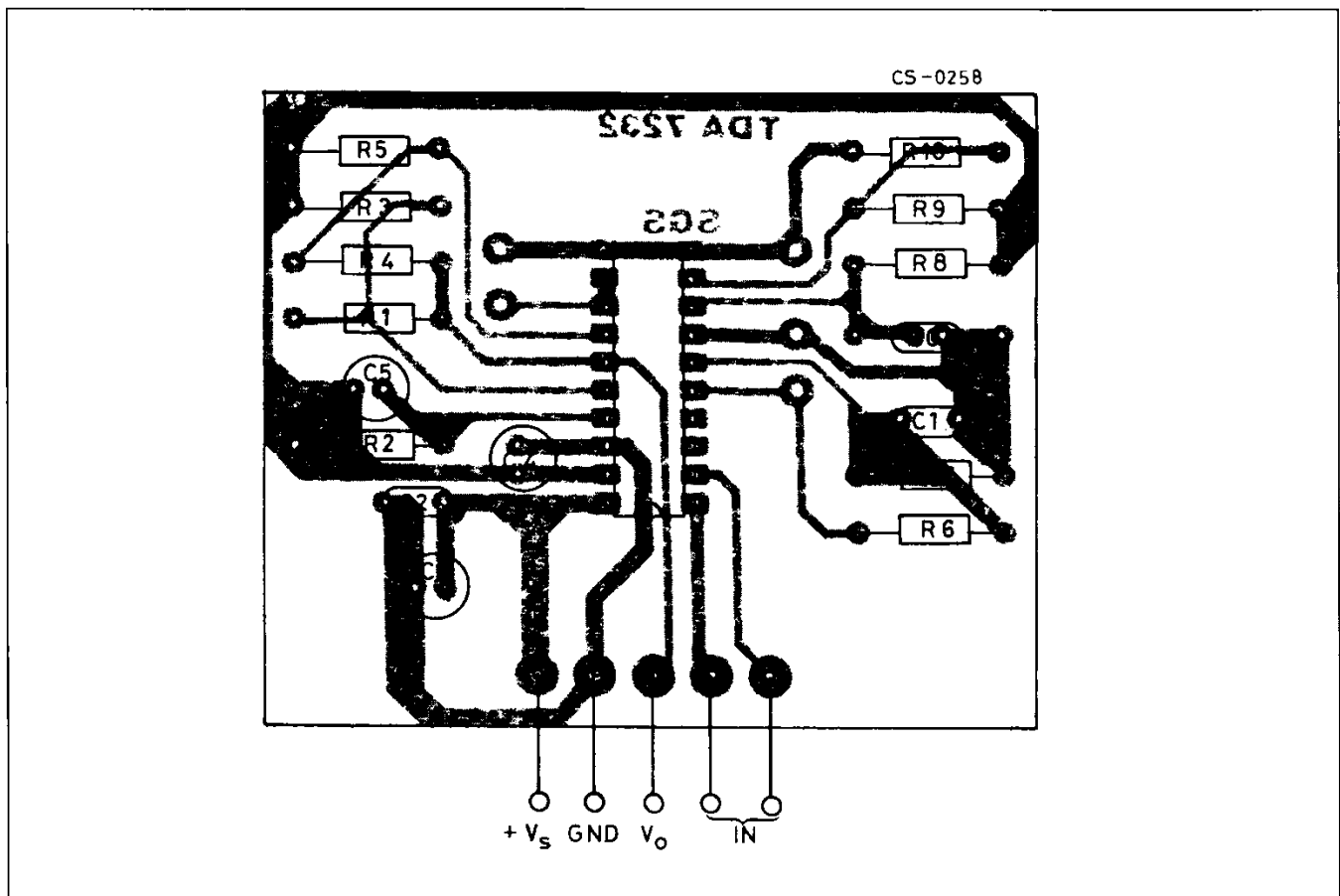

Figure 3 : Supply Current vs. Supply Voltage (complete test circuit).

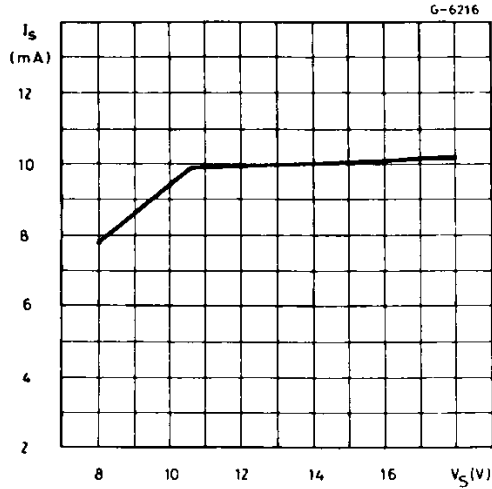

Figure 4 : Compression Characteristics.

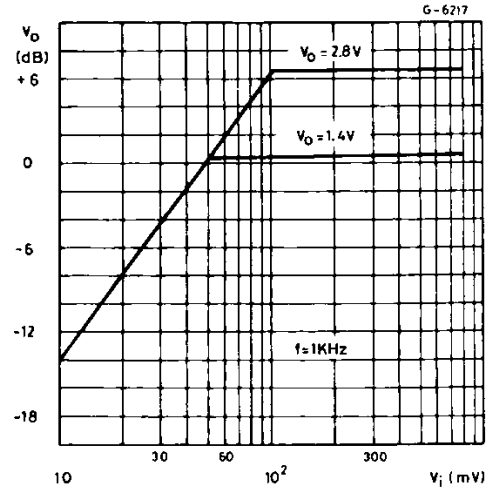

Figure 5 : Distortion vs. Frequency (complete test circuit).

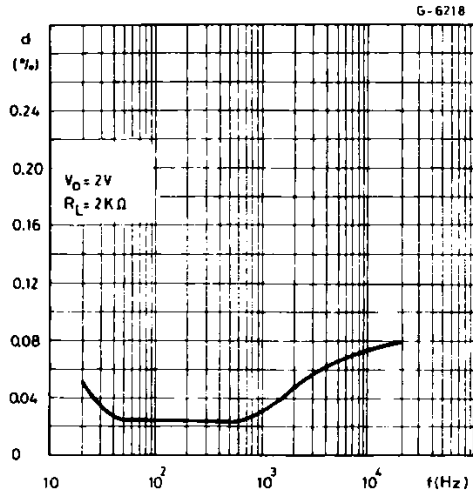

Figure 6 : Distortion vs. Input Signal Level (complete test circuit).

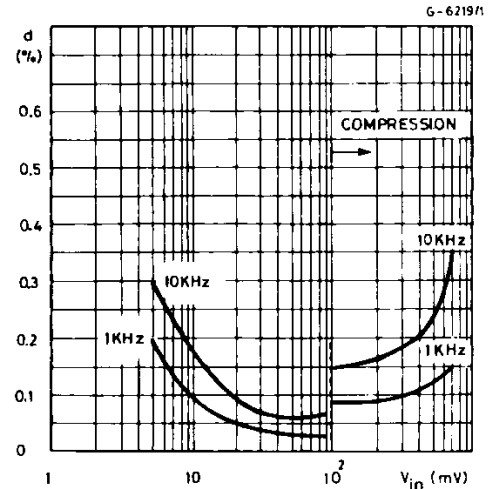

Figure 7 : Supply Voltage Rejection vs. Frequency (complete test circuit).

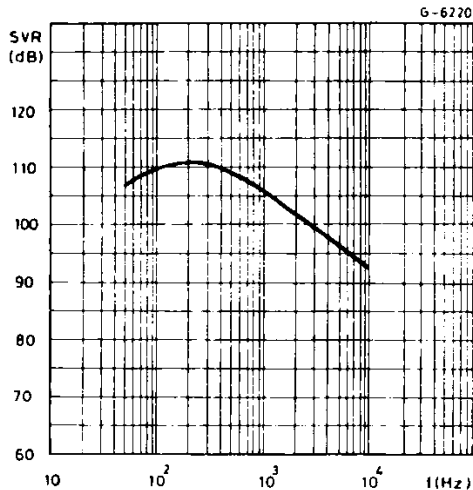

Figure 8 : Distortion vs. Output Voltage (input differ. amplifier).

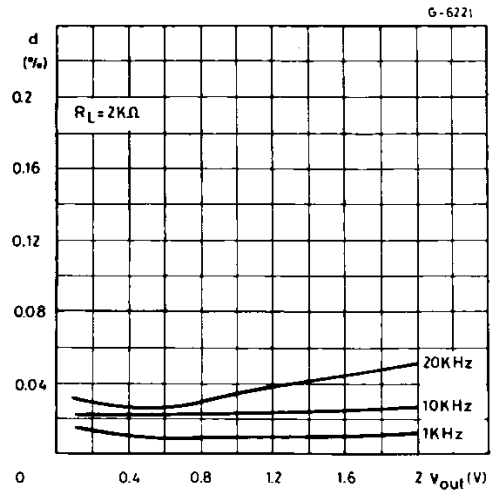

Figure 9 : Distortion vs. Frequency (input differ. amplifier).

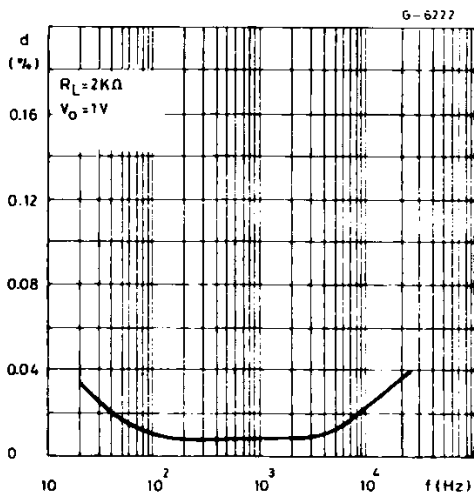

Figure 10 : Distortion vs. Output Voltage (compressor).

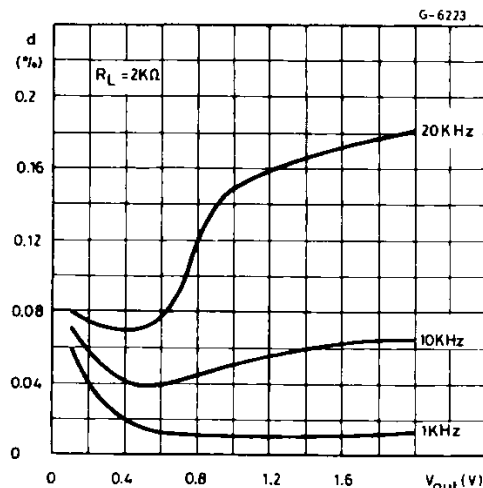

Figure 11 : Distortion vs. Frequency (compressor).

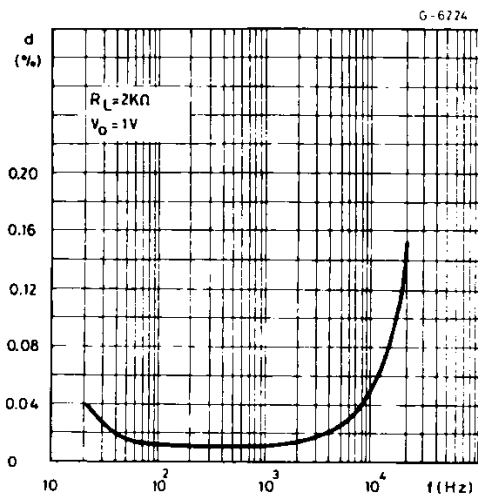

Figure 12 : Distortion vs. Output Voltage (op. amp. 1 & 3).

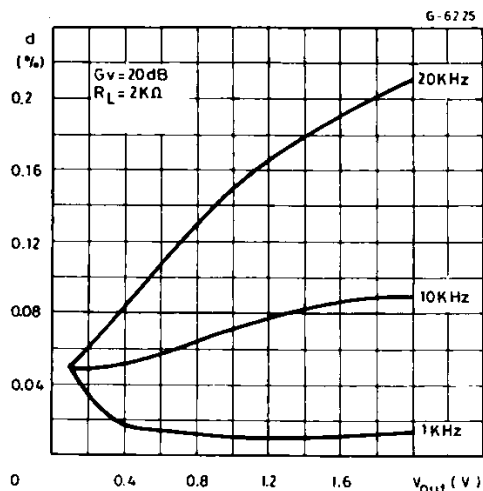

Figure 13 : Distortion vs. Frequency (op. amp. 1 & 3).

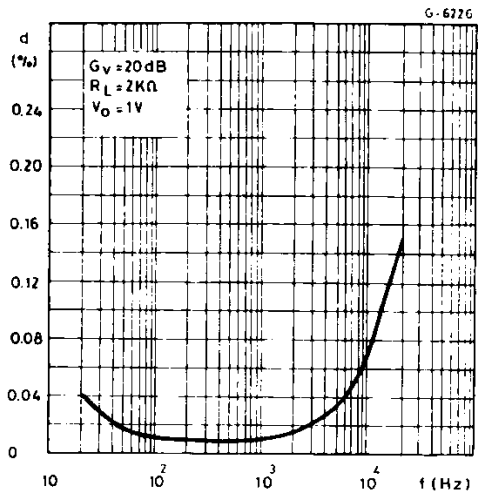

Figure 14 : Open Loop Frequency and Phase Response (op. amp. 1 & 3).

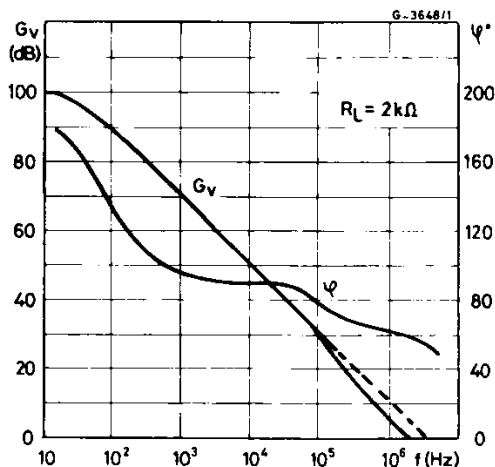

Figure 15 : Distortion vs. Output Voltage
(op. amp. 2).

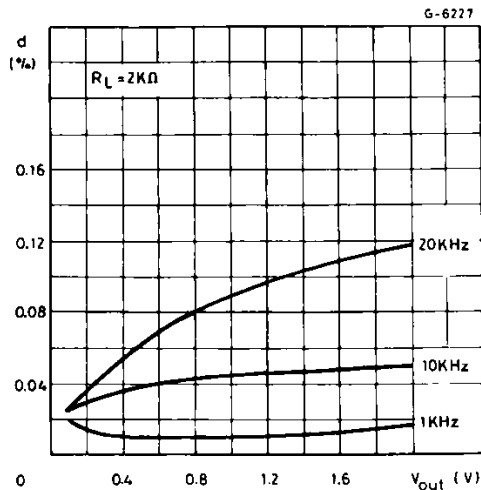
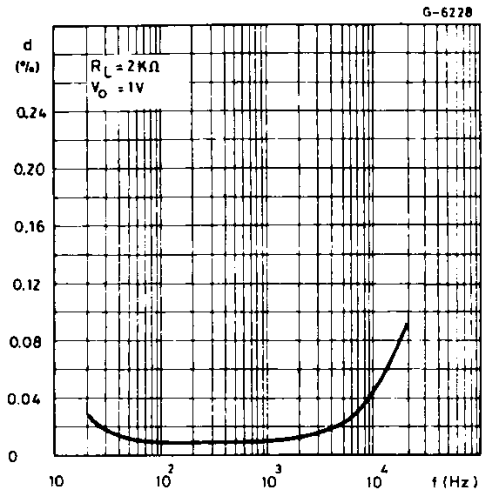

Figure 16 : Distortion vs. Frequency
(op. amp. 2).



APPLICATION INFORMATION

The devices TDA7232 and TDA7260 realize with four external POWER MOS an exclusive audio system for car radio, thanks to their unique feature as:

- 25 W output power ($d = 0.3\%$) without heatsink, thanks to the extra-high efficiency (85 % typ. at rated output power) of the power stage, which operates in class "D" (pulse width modulation).
- In-car frequency response compensation,

thanks to the availability of several operational amplifiers for the necessary equalization.

- High-quality sound at all listening levels, thanks to an appropriate compressor circuit that avoids clipping in the system.
- Low distortion, low noise, fully protected operation of the whole system.

Figure 17 : Suggested Application Using the TDA7260 Audio PWM Amplifier.

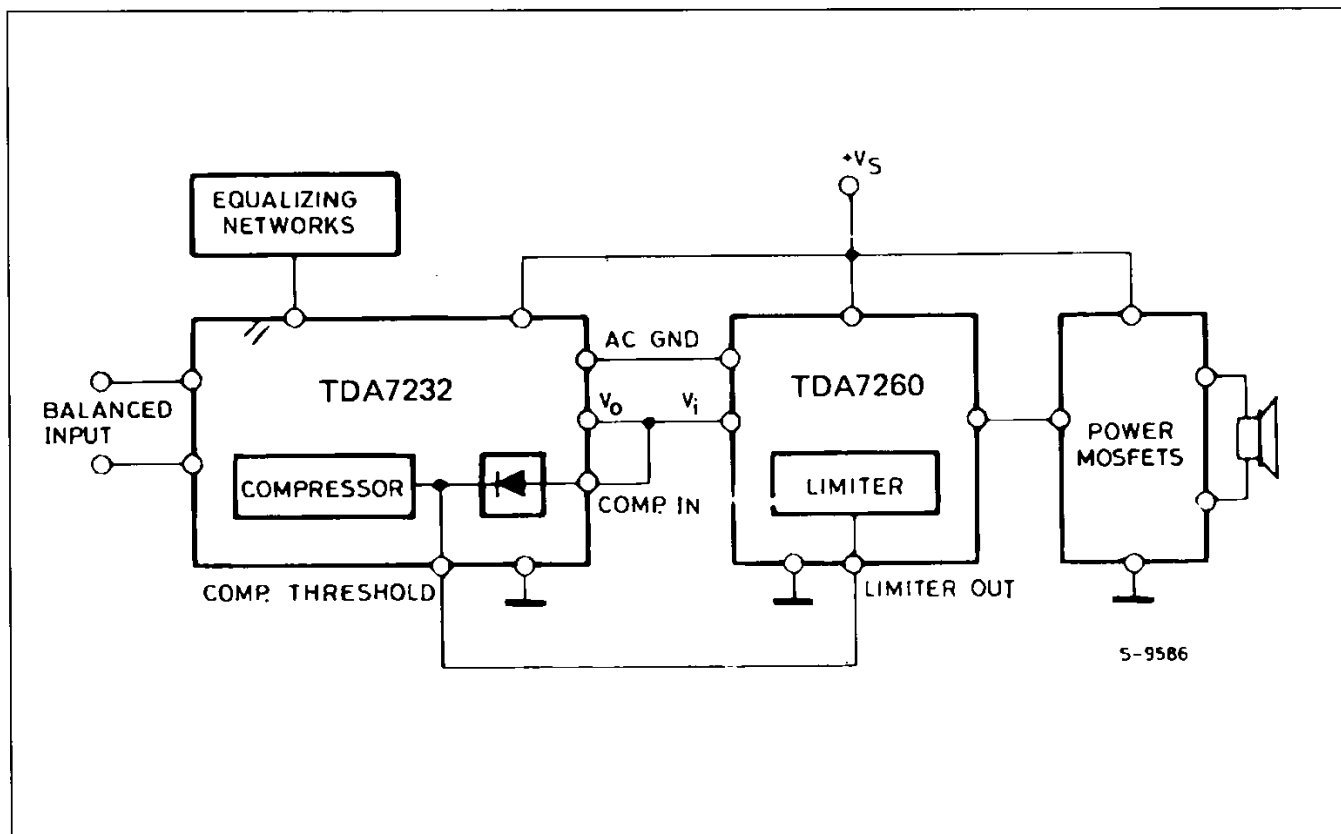
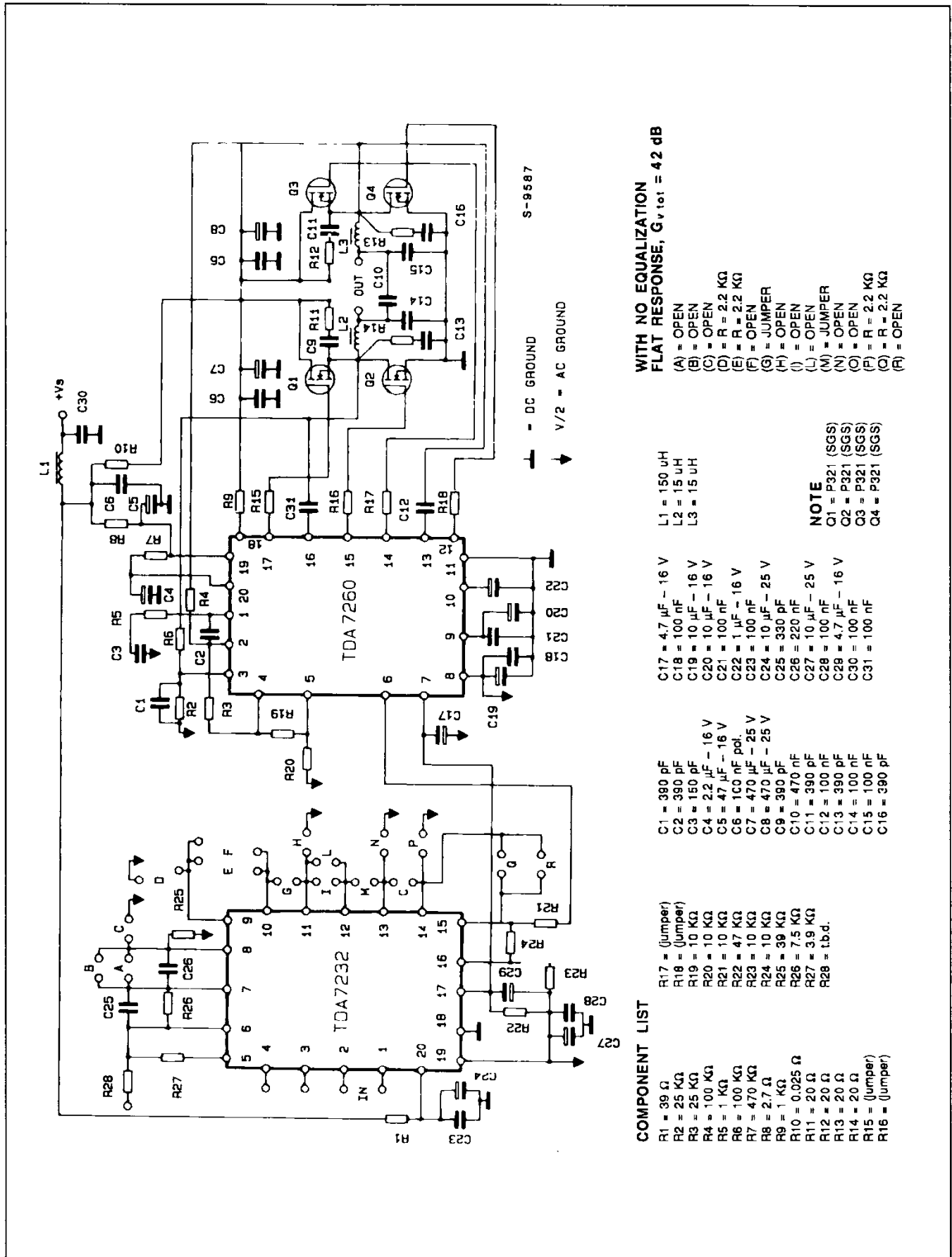

Figure 18 : 25 W Application Circuit Using the TDA7260 Audio PWM.



WITH NO EQUALIZATION
FLAT RESPONSE, $G_{v\text{tot}} = 42 \text{ dB}$

- (A) = OPEN
- (B) = OPEN
- (C) = OPEN
- (D) = R = 2.2 K Ω
- (E) = R = 2.2 K Ω
- (F) = OPEN
- (G) = JUMPER
- (H) = OPEN
- (I) = OPEN
- (L) = OPEN
- (M) = JUMPER
- (N) = OPEN
- (O) = OPEN
- (P) = R = 2.2 K Ω
- (Q) = R = 2.2 K Ω
- (R) = OPEN

- L1 = 150 μH
- L2 = 15 μH
- L3 = 15 μH

NOTE
 Q1 = P321 (SGS)
 Q2 = P321 (SGS)
 Q3 = P321 (SGS)
 Q4 = P321 (SGS)

- C17 = 4.7 μF - 16 V
- C18 = 100 nF
- C19 = 10 μF - 16 V
- C20 = 10 μF - 16 V
- C21 = 100 nF
- C22 = 1 μF - 16 V
- C23 = 100 nF
- C24 = 10 μF - 25 V
- C25 = 330 pF
- C26 = 220 nF
- C27 = 10 μF - 25 V
- C28 = 100 nF
- C29 = 4.7 μF - 16 V
- C30 = 100 nF
- C31 = 100 nF

- C1 = 390 pF
- C2 = 390 pF
- C3 = 150 pF
- C4 = 2.2 μF - 16 V
- C5 = 47 μF - 16 V
- C6 = 100 nF pol.
- C7 = 470 μF - 25 V
- C8 = 470 μF - 25 V
- C9 = 390 pF
- C10 = 470 nF
- C11 = 10 μF - 25 V
- C12 = 100 nF
- C13 = 390 pF
- C14 = 100 nF
- C15 = 100 nF
- C16 = 390 pF

COMPONENT LIST

- R1 = 39 Ω
- R2 = 25 K Ω
- R3 = 25 K Ω
- R4 = 100 K Ω
- R5 = 1 K Ω
- R6 = 100 K Ω
- R7 = 470 K Ω
- R8 = 2.7 Ω
- R9 = 1 K Ω
- R10 = 0.025 Ω
- R11 = 20 Ω
- R12 = 20 Ω
- R13 = 20 Ω
- R14 = 20 Ω
- R15 = (Jumper)
- R16 = (Jumper)
- R17 = (Jumper)
- R18 = 10 K Ω
- R19 = 10 K Ω
- R20 = 10 K Ω
- R21 = 10 K Ω
- R22 = 47 K Ω
- R23 = 10 K Ω
- R24 = 10 K Ω
- R25 = 39 K Ω
- R26 = 7.5 K Ω
- R27 = 3.9 K Ω
- R28 = t.b.d.
- R29 = (Jumper)
- R30 = (Jumper)
- R31 = (Jumper)
- R32 = (Jumper)
- R33 = (Jumper)
- R34 = (Jumper)
- R35 = (Jumper)
- R36 = (Jumper)
- R37 = (Jumper)
- R38 = (Jumper)
- R39 = (Jumper)
- R40 = (Jumper)
- R41 = (Jumper)
- R42 = (Jumper)
- R43 = (Jumper)
- R44 = (Jumper)
- R45 = (Jumper)
- R46 = (Jumper)
- R47 = (Jumper)
- R48 = (Jumper)
- R49 = (Jumper)
- R50 = (Jumper)
- R51 = (Jumper)
- R52 = (Jumper)
- R53 = (Jumper)
- R54 = (Jumper)
- R55 = (Jumper)
- R56 = (Jumper)
- R57 = (Jumper)
- R58 = (Jumper)
- R59 = (Jumper)
- R60 = (Jumper)
- R61 = (Jumper)
- R62 = (Jumper)
- R63 = (Jumper)
- R64 = (Jumper)
- R65 = (Jumper)
- R66 = (Jumper)
- R67 = (Jumper)
- R68 = (Jumper)
- R69 = (Jumper)
- R70 = (Jumper)
- R71 = (Jumper)
- R72 = (Jumper)
- R73 = (Jumper)
- R74 = (Jumper)
- R75 = (Jumper)
- R76 = (Jumper)
- R77 = (Jumper)
- R78 = (Jumper)
- R79 = (Jumper)
- R80 = (Jumper)
- R81 = (Jumper)
- R82 = (Jumper)
- R83 = (Jumper)
- R84 = (Jumper)
- R85 = (Jumper)
- R86 = (Jumper)
- R87 = (Jumper)
- R88 = (Jumper)
- R89 = (Jumper)
- R90 = (Jumper)
- R91 = (Jumper)
- R92 = (Jumper)
- R93 = (Jumper)
- R94 = (Jumper)
- R95 = (Jumper)
- R96 = (Jumper)
- R97 = (Jumper)
- R98 = (Jumper)
- R99 = (Jumper)
- R100 = (Jumper)

Figure 19 : P.C. Board and Components Layout for the Circuit of Fig. 18 (1 : 1 scale).

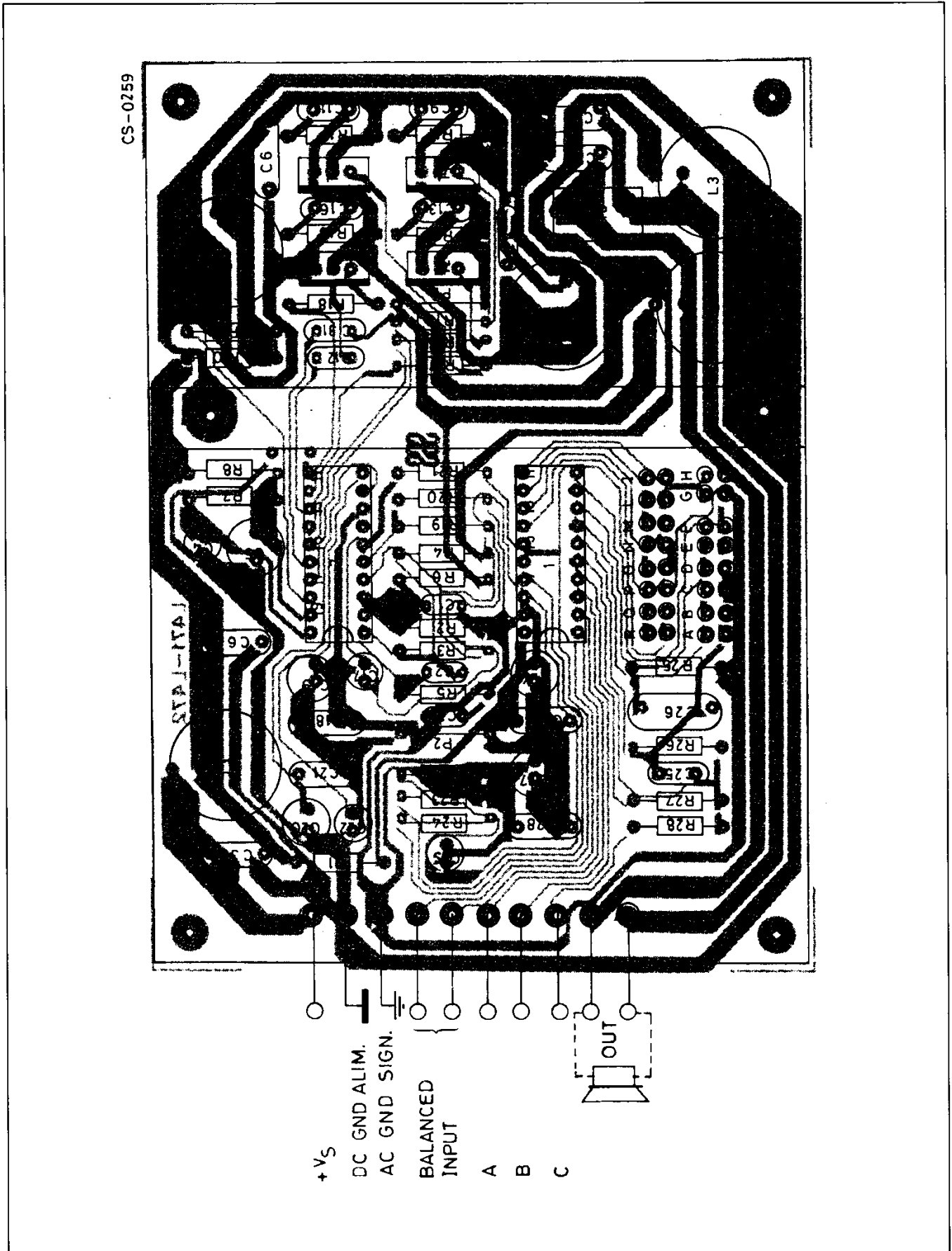

Figure 20 : Five Bands Equalizer with Compression Indicator.

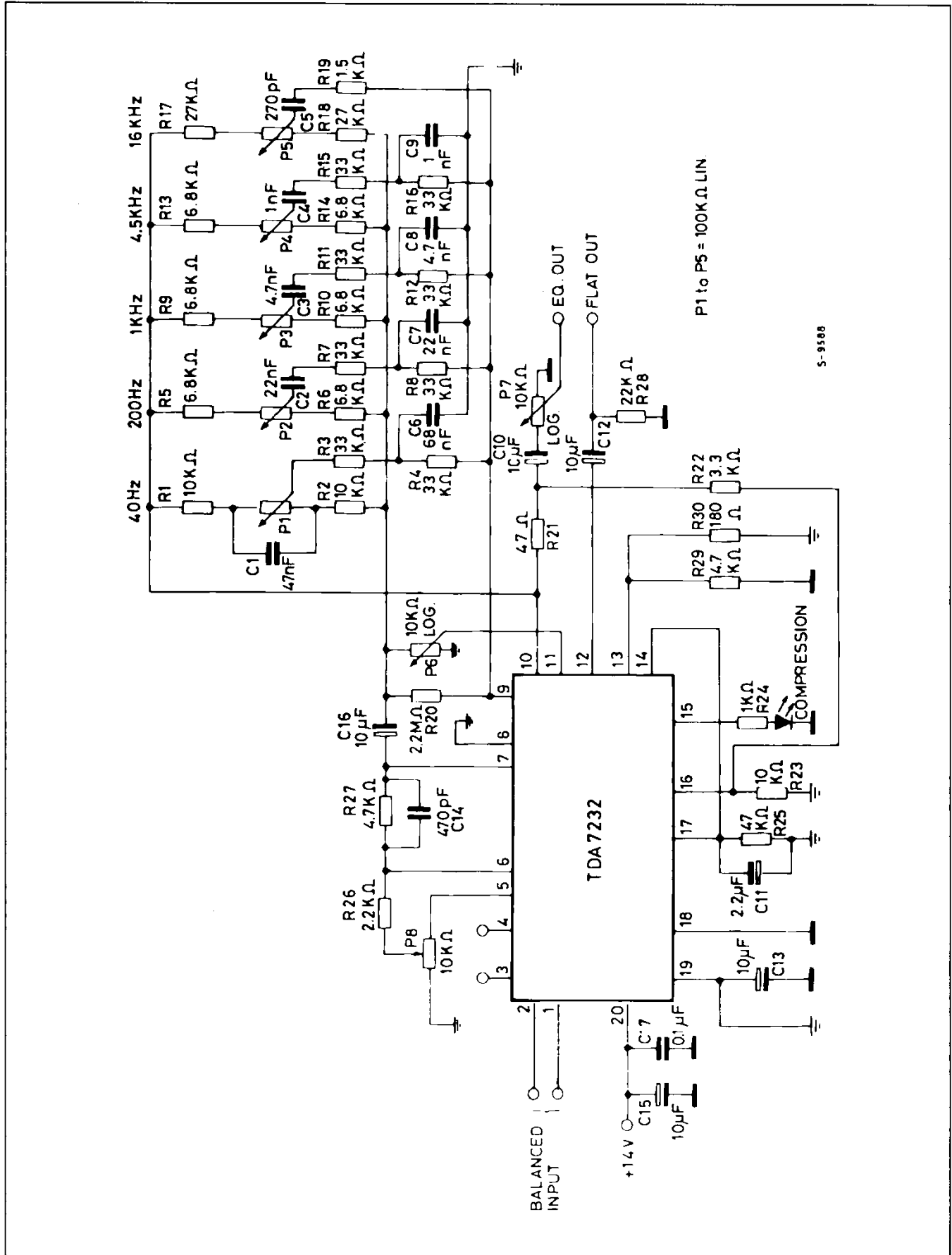

Figure 21 : P.C. and Components Layout for the Circuit of Fig. 20 (1 : 1 scale).

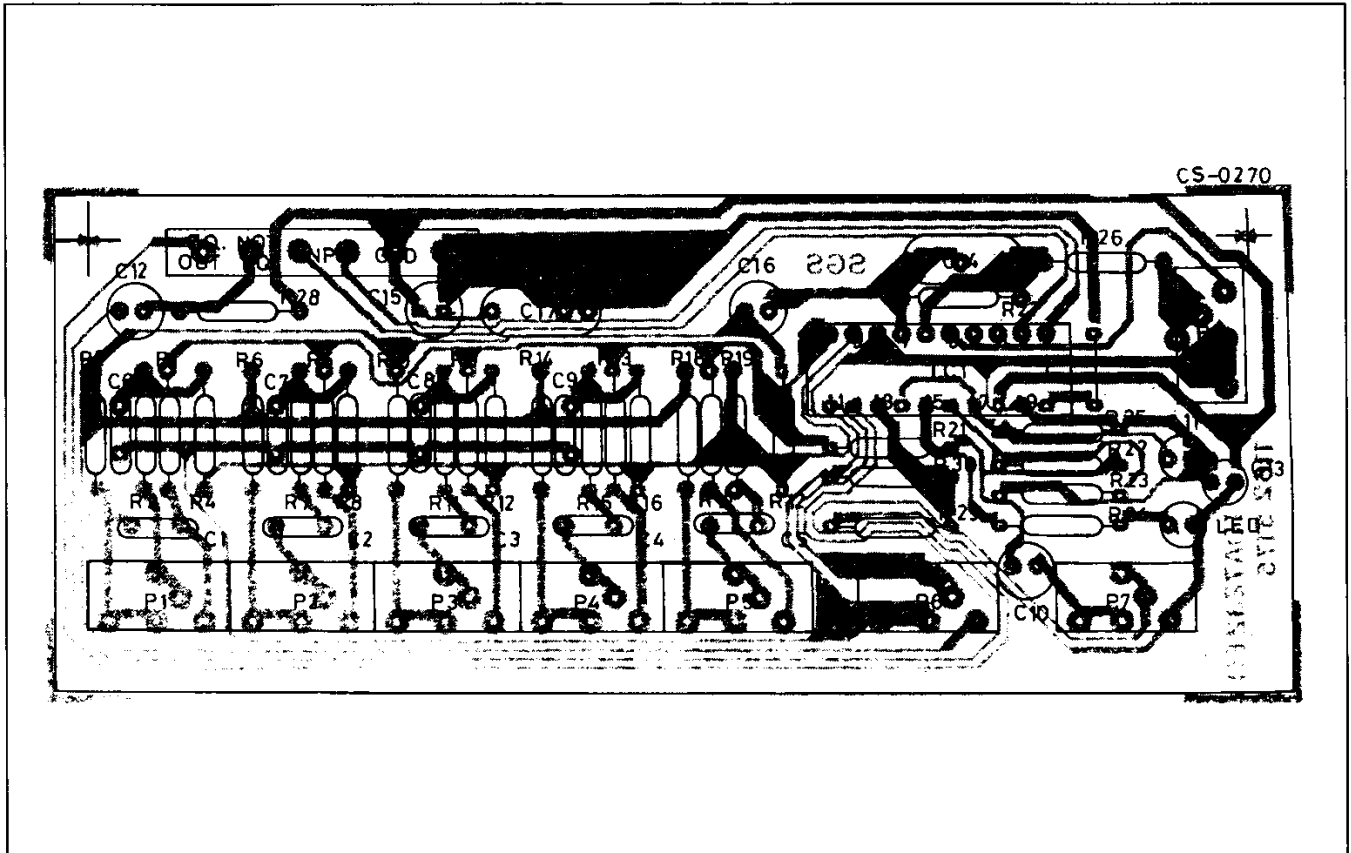

Figure 22 : Frequency Response of the five Bands Equalizer Circuit.

