

Low Quiescent Current LDO

Features

- 1.6 μ A Typical Quiescent Current
- Input Operating Voltage Range: 2.3V to 6.0V
- Output Voltage Range: 1.2V to 5.0V
- 250 mA Output Current for output voltages \geq 2.5V
- 200 mA Output Current for output voltages $<$ 2.5V
- Low Dropout (LDO) voltage
 - 178 mV typical @ 250 mA for $V_{OUT} = 2.8V$
- 0.4% Typical Output Voltage Tolerance
- Standard Output Voltage Options:
 - 1.2V, 1.8V, 2.5V, 3.0V, 3.3V, 5.0V
- Stable with 1.0 μ F Ceramic Output capacitor
- Short-Circuit Protection
- Overtemperature Protection

Applications

- Battery-powered Devices
- Battery-powered Alarm Circuits
- Smoke Detectors
- CO² Detectors
- Pagers and Cellular Phones
- Smart Battery Packs
- Low Quiescent Current Voltage Reference
- PDAs
- Digital Cameras
- Microcontroller Power

Related Literature

- AN765, "Using Microchip's Micropower LDOs", DS00765, Microchip Technology Inc., 2002
- AN766, "Pin-Compatible CMOS Upgrades to BiPolar LDOs", DS00766, Microchip Technology Inc., 2002
- AN792, "A Method to Determine How Much Power a SOT23 Can Dissipate in an Application", DS00792, Microchip Technology Inc., 2001

Description

The MCP1700 is a family of CMOS low dropout (LDO) voltage regulators that can deliver up to 250 mA of current while consuming only 1.6 μ A of quiescent current (typical). The input operating range is specified from 2.3V to 6.0V, making it an ideal choice for two and three primary cell battery-powered applications, as well as single cell Li-Ion-powered applications.

The MCP1700 is capable of delivering 250 mA with only 178 mV of input to output voltage differential ($V_{OUT} = 2.8V$). The output voltage tolerance of the MCP1700 is typically $\pm 0.4\%$ at $+25^{\circ}C$ and $\pm 3\%$ maximum over the operating junction temperature range of $-40^{\circ}C$ to $+125^{\circ}C$.

Output voltages available for the MCP1700 range from 1.2V to 5.0V. The LDO output is stable when using only 1 μ F output capacitance. Ceramic, tantalum or aluminum electrolytic capacitors can all be used for input and output. Overcurrent limit and overtemperature shutdown provide a robust solution for any application.

Package options include the SOT23, SOT89-3 and TO92.

Package Types

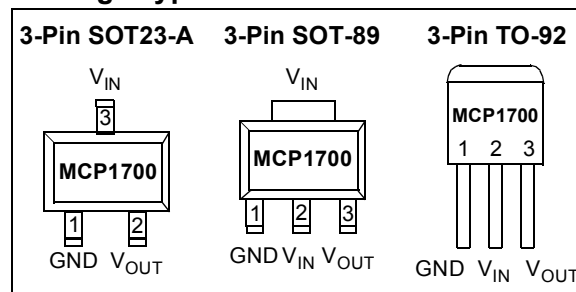

MCP1700

Functional Block Diagrams

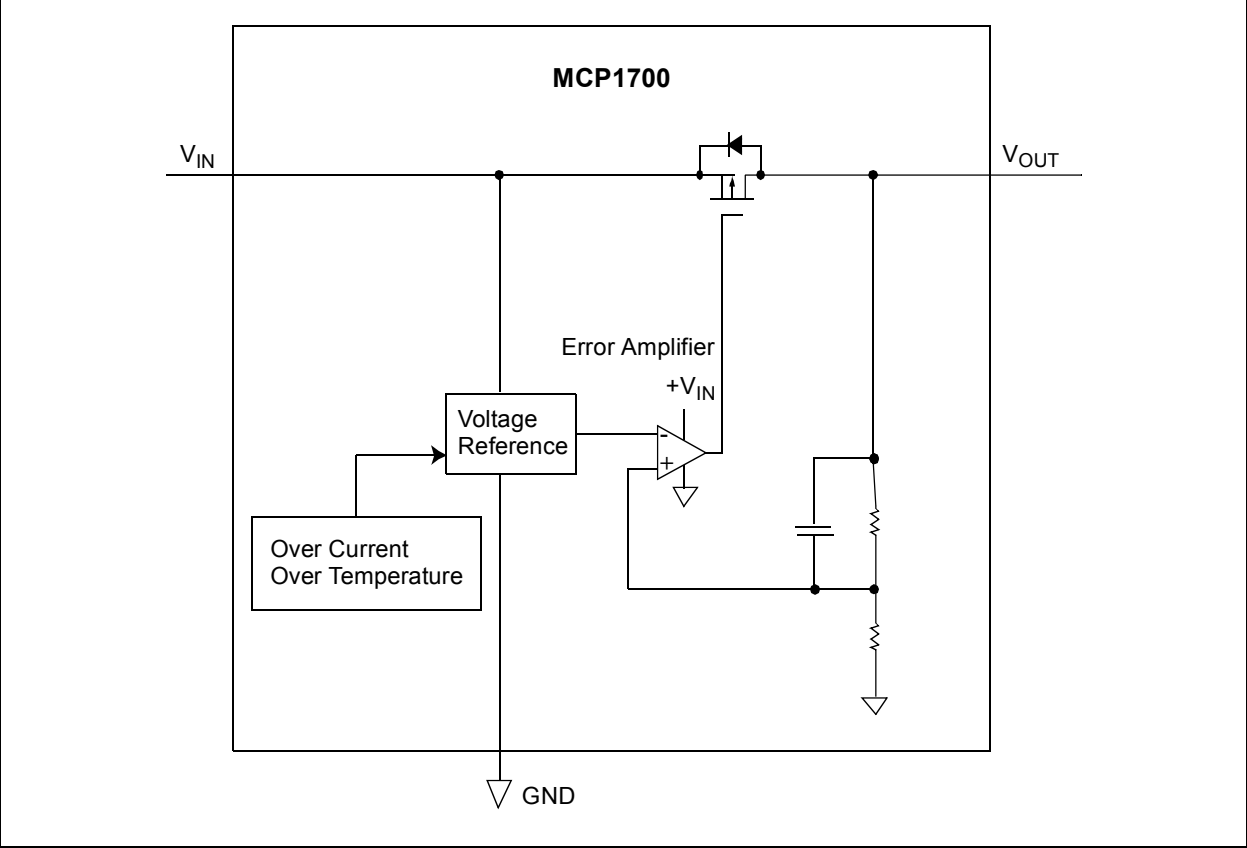

Typical Application Circuits

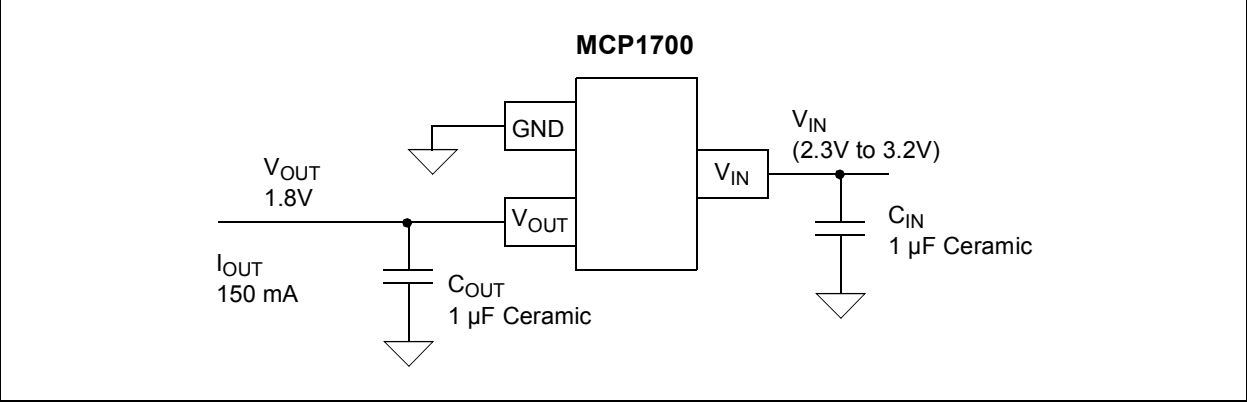

1.0 ELECTRICAL CHARACTERISTICS

Absolute Maximum Ratings †

V _{DD}	+6.5V
All inputs and outputs w.r.t.	(V _{SS} -0.3V) to (V _{IN} +0.3V)
Peak Output Current	Internally Limited
Storage temperature	-65°C to +150°C
Maximum Junction Temperature.....	150°C
Operating Junction Temperature.....	-40°C to +125°C
ESD protection on all pins (HBM;MM).....	≥ 4 kV; ≥ 400V

† **Notice:** Stresses above those listed under “Maximum Ratings” may cause permanent damage to the device. This is a stress rating only and functional operation of the device at those or any other conditions above those indicated in the operational listings of this specification is not implied. Exposure to maximum rating conditions for extended periods may affect device reliability.

DC CHARACTERISTICS

Electrical Characteristics: Unless otherwise specified, all limits are established for V_{IN} = V_R + 1, I_{LOAD} = 100 μA, C_{OUT} = 1 μF (X5R), C_{IN} = 1 μF (X5R), T_A = +25°C.

Boldface type applies for junction temperatures, T_J (**Note 6**) of -40°C to +125°C.

Parameters	Sym	Min	Typ	Max	Units	Conditions
Input / Output Characteristics						
Input Operating Voltage	V _{IN}	2.3	—	6.0	V	Note 1
Input Quiescent Current	I _q	—	1.6	4	μA	I _L = 0 mA, V _{IN} = V _R + 1V
Maximum Output Current	I _{OUT_mA}	250 200	—	—	mA	For V _R ≥ 2.5V For V _R < 2.5V
Output Short Circuit Current	I _{OUT_SC}	—	408	—	mA	V _{IN} = V _R + 1V, V _{OUT} = GND, Current (peak current) measured 10 ms after short is applied.
Output Voltage Regulation	V _{OUT}	V_R-3.0% V_R-2.0%	V _R ±0.4 %	V_R+3.0% V_R+2.0%	V	Note 2
V _{OUT} Temperature Coefficient	TCV _{OUT}	—	50	—	ppm/°C	Note 3
Line Regulation	$\frac{\Delta V_{OUT}}{(V_{OUT} \times \Delta V_{IN})}$	-1.0	±0.75	+1.0	%/V	(V _R +1)V ≤ V _{IN} ≤ 6V
Load Regulation	$\frac{\Delta V_{OUT}}{V_{OUT}}$	-1.5	±1.0	+1.5	%	I _L = 0.1 mA to 250 mA for V _R ≥ 2.5V I _L = 0.1 mA to 200 mA for V _R < 2.5V Note 4
Dropout Voltage V _R > 2.5V	V _{IN} -V _{OUT}	—	178	350	mV	I _L = 250 mA, (Note 1, Note 5)
Dropout Voltage V _R < 2.5V	V _{IN} -V _{OUT}	—	150	350	mV	I _L = 200 mA, (Note 1, Note 5)
Output Rise Time	T _R	—	500	—	μs	10% V _R to 90% V _R V _{IN} = 0V to 6V, R _L = 50Ω resistive

- Note 1:** The minimum V_{IN} must meet two conditions: V_{IN} ≥ 2.3V and V_{IN} ≥ (V_R + 3.0%) + V_{DROPOUT}.
- Note 2:** V_R is the nominal regulator output voltage. For example: V_R = 1.2V, 1.5V, 1.8V, 2.5V, 2.8V, 3.0V, 3.3V, 4.0V, 5.0V. The input voltage (V_{IN} = V_R + 1.0V); I_{OUT} = 100 μA.
- Note 3:** TCV_{OUT} = (V_{OUT-HIGH} - V_{OUT-LOW}) * 10⁶ / (V_R * ΔTemperature). V_{OUT-HIGH} = highest voltage measured over the temperature range. V_{OUT-LOW} = lowest voltage measured over the temperature range.
- Note 4:** Load regulation is measured at a constant junction temperature using low duty cycle pulse testing. Changes in output voltage due to heating effects are determined using thermal regulation specification TCV_{OUT}.
- Note 5:** Dropout voltage is defined as the input to output differential at which the output voltage drops 2% below its measured value with a V_R + 1V differential applied.
- Note 6:** The maximum allowable power dissipation is a function of ambient temperature, the maximum allowable junction temperature and the thermal resistance from junction to air (i.e., T_A, T_J, θ_{JA}). Exceeding the maximum allowable power dissipation will cause the device operating junction temperature to exceed the maximum 150°C rating. Sustained junction temperatures above 150°C can impact the device reliability.
- Note 7:** The junction temperature is approximated by soaking the device under test at an ambient temperature equal to the desired Junction temperature. The test time is small enough such that the rise in the Junction temperature over the ambient temperature is not significant.

MCP1700

DC CHARACTERISTICS (CONTINUED)

Electrical Characteristics: Unless otherwise specified, all limits are established for $V_{IN} = V_R + 1$, $I_{LOAD} = 100 \mu A$, $C_{OUT} = 1 \mu F$ (X5R), $C_{IN} = 1 \mu F$ (X5R), $T_A = +25^\circ C$.

Boldface type applies for junction temperatures, T_J (**Note 6**) of $-40^\circ C$ to $+125^\circ C$.

Parameters	Sym	Min	Typ	Max	Units	Conditions
Output Noise	e_N	—	3	—	$\mu V/(Hz)^{1/2}$	$I_L = 100 mA$, $f = 1 kHz$, $C_{OUT} = 1 \mu F$
Power Supply Ripple Rejection Ratio	PSRR	—	44	—	dB	$f = 100 Hz$, $C_{OUT} = 1 \mu F$, $I_L = 50 mA$, $V_{INAC} = 100 mV$ pk-pk, $C_{IN} = 0 \mu F$, $V_R = 1.2V$
Thermal Shutdown Protection	T_{SD}	—	140	—	$^\circ C$	$V_{IN} = V_R + 1$, $I_L = 100 \mu A$

- Note 1:** The minimum V_{IN} must meet two conditions: $V_{IN} \geq 2.3V$ and $V_{IN} \geq (V_R + 3.0\%) + V_{DROPOUT}$.
- 2:** V_R is the nominal regulator output voltage. For example: $V_R = 1.2V, 1.5V, 1.8V, 2.5V, 2.8V, 3.0V, 3.3V, 4.0V, 5.0V$. The input voltage ($V_{IN} = V_R + 1.0V$); $I_{OUT} = 100 \mu A$.
- 3:** $TCV_{OUT} = (V_{OUT-HIGH} - V_{OUT-LOW}) * 10^6 / (V_R * \Delta Temperature)$, $V_{OUT-HIGH}$ = highest voltage measured over the temperature range. $V_{OUT-LOW}$ = lowest voltage measured over the temperature range.
- 4:** Load regulation is measured at a constant junction temperature using low duty cycle pulse testing. Changes in output voltage due to heating effects are determined using thermal regulation specification TCV_{OUT} .
- 5:** Dropout voltage is defined as the input to output differential at which the output voltage drops 2% below its measured value with a $V_R + 1V$ differential applied.
- 6:** The maximum allowable power dissipation is a function of ambient temperature, the maximum allowable junction temperature and the thermal resistance from junction to air (i.e., T_A, T_J, θ_{JA}). Exceeding the maximum allowable power dissipation will cause the device operating junction temperature to exceed the maximum $150^\circ C$ rating. Sustained junction temperatures above $150^\circ C$ can impact the device reliability.
- 7:** The junction temperature is approximated by soaking the device under test at an ambient temperature equal to the desired Junction temperature. The test time is small enough such that the rise in the Junction temperature over the ambient temperature is not significant.

TEMPERATURE SPECIFICATIONS

Electrical Characteristics: Unless otherwise specified, all limits are established for $V_{IN} = V_R + 1$, $I_{LOAD} = 100 \mu A$, $C_{OUT} = 1 \mu F$ (X5R), $C_{IN} = 1 \mu F$ (X5R), $T_A = +25^\circ C$.

Boldface type applies for junction temperatures, T_J (**Note 1**) of $-40^\circ C$ to $+125^\circ C$.

Parameters	Sym	Min	Typ	Max	Units	Conditions
Temperature Ranges						
Specified Temperature Range	T_A	-40		+125	$^\circ C$	
Operating Temperature Range	T_A	-40		+125	$^\circ C$	
Storage Temperature Range	T_A	-65		+150	$^\circ C$	
Thermal Package Resistance						
Thermal Resistance, SOT23-A	θ_{JA}	—	335	—	$^\circ C/W$	Minimum Trace Width Single Layer Board
		—	230	—	$^\circ C/W$	Typical FR4 4-layer Application
Thermal Resistance, SOT89	θ_{JA}	—	52	—	$^\circ C/W$	Typical, 1 square inch of copper
Thermal Resistance, TO-92	θ_{JA}	—	131.9	—	$^\circ C/W$	EIA/JEDEC JESD51-751-7 4-Layer Board

- Note 1:** The maximum allowable power dissipation is a function of ambient temperature, the maximum allowable junction temperature and the thermal resistance from junction to air (i.e., T_A, T_J, θ_{JA}). Exceeding the maximum allowable power dissipation will cause the device operating junction temperature to exceed the maximum $150^\circ C$ rating. Sustained junction temperatures above $150^\circ C$ can impact the device reliability.

2.0 TYPICAL PERFORMANCE CURVES

Note: The graphs and tables provided following this note are a statistical summary based on a limited number of samples and are provided for informational purposes only. The performance characteristics listed herein are not tested or guaranteed. In some graphs or tables, the data presented may be outside the specified operating range (e.g., outside specified power supply range) and therefore outside the warranted range.

Note: Unless otherwise indicated: $V_R = 1.8V$, $C_{OUT} = 1 \mu F$ Ceramic (X5R), $C_{IN} = 1 \mu F$ Ceramic (X5R), $I_L = 100 \mu A$, $T_A = +25^\circ C$, $V_{IN} = V_R + 1V$.

Note: Junction Temperature (T_J) is approximated by soaking the device under test to an ambient temperature equal to the desired junction temperature. The test time is small enough such that the rise in Junction temperature over the Ambient temperature is not significant.

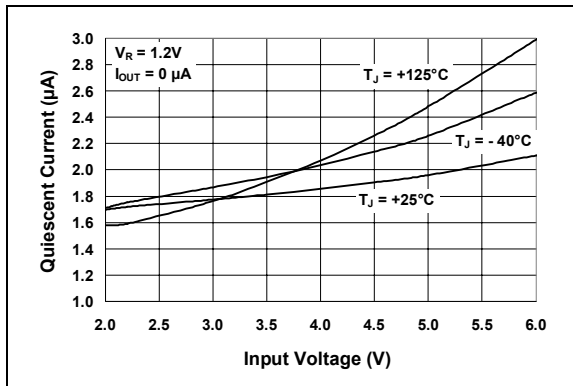

FIGURE 2-1: Input Quiescent Current vs. Input Voltage.

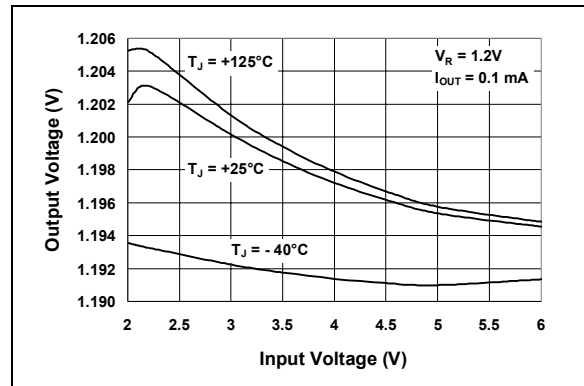

FIGURE 2-4: Output Voltage vs. Input Voltage ($V_R = 1.2V$).

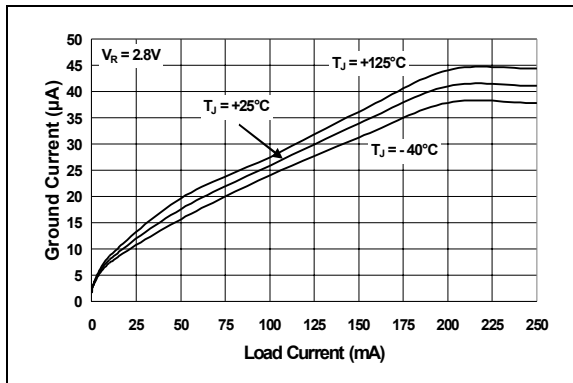

FIGURE 2-2: Ground Current vs. Load Current.

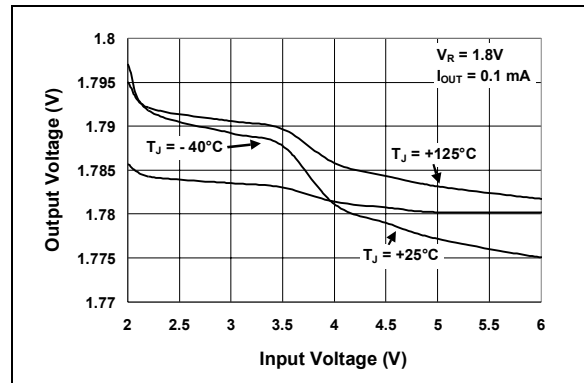

FIGURE 2-5: Output Voltage vs. Input Voltage ($V_R = 1.8V$).

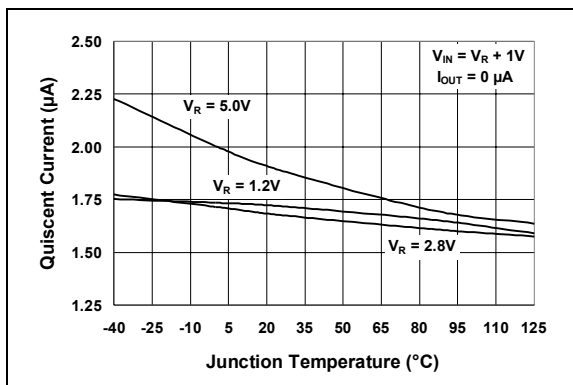

FIGURE 2-3: Quiescent Current vs. Junction Temperature.

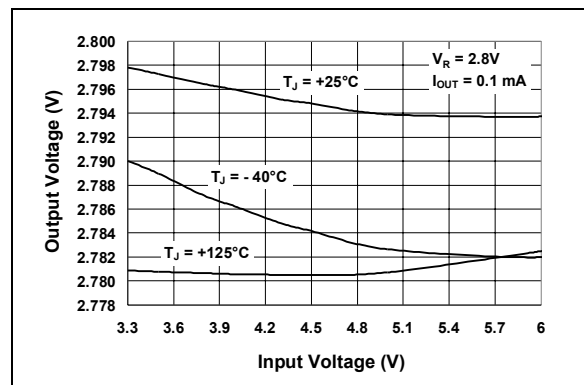

FIGURE 2-6: Output Voltage vs. Input Voltage ($V_R = 2.8V$).

MCP1700

Note: Unless otherwise indicated: $V_R = 1.8V$, $C_{OUT} = 1 \mu F$ Ceramic (X5R), $C_{IN} = 1 \mu F$ Ceramic (X5R), $I_L = 100 \mu A$, $T_A = +25^\circ C$, $V_{IN} = V_R + 1V$.

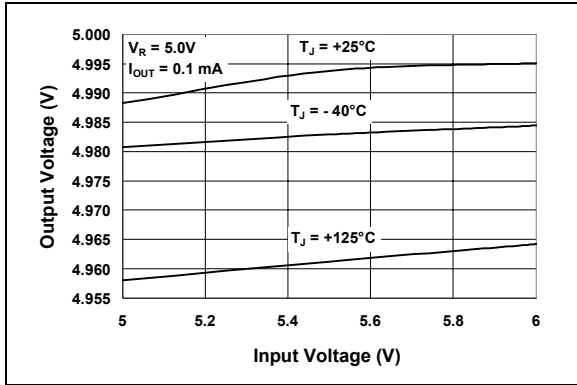

FIGURE 2-7: Output Voltage vs. Input Voltage ($V_R = 5.0V$).

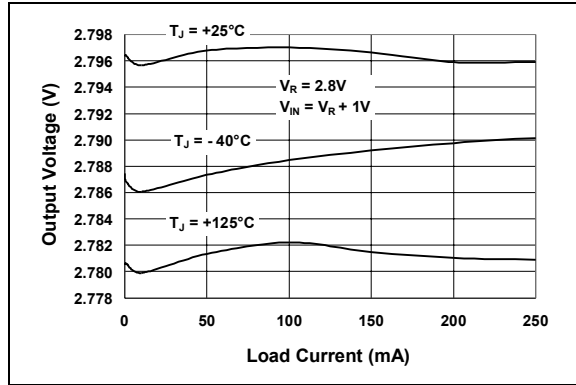

FIGURE 2-10: Output Voltage vs. Load Current ($V_R = 2.8V$).

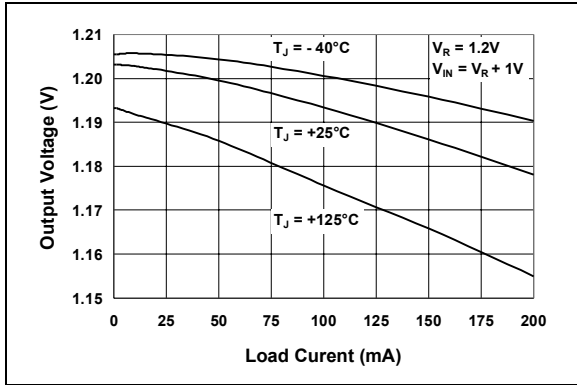

FIGURE 2-8: Output Voltage vs. Load Current ($V_R = 1.2V$).

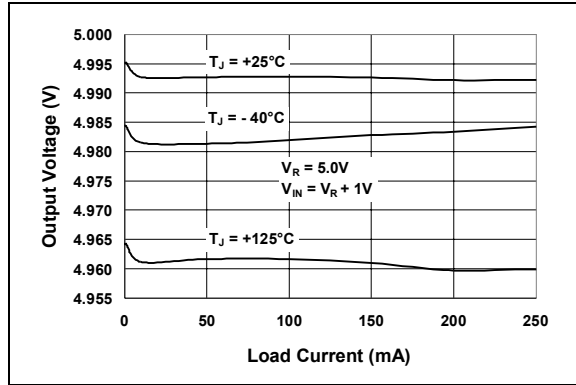

FIGURE 2-11: Output Voltage vs. Load Current ($V_R = 5.0V$).

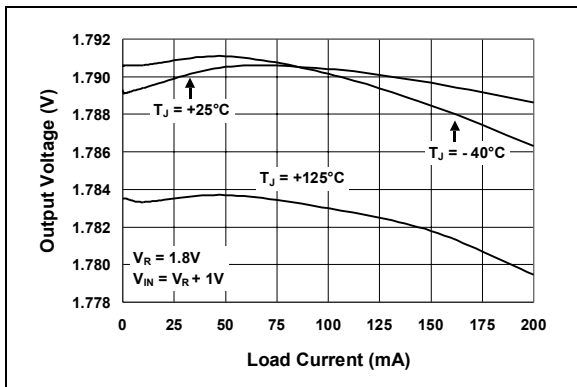

FIGURE 2-9: Output Voltage vs. Load Current ($V_R = 1.8V$).

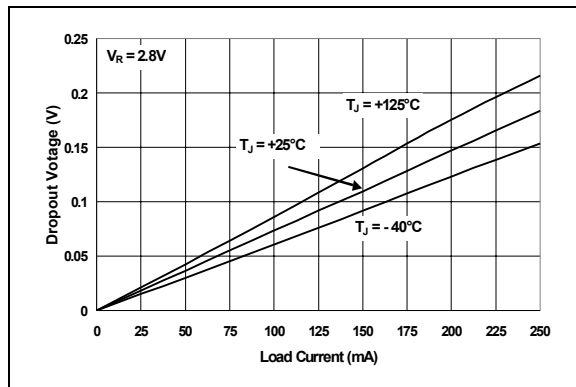

FIGURE 2-12: Dropout Voltage vs. Load Current ($V_R = 2.8V$).

Note: Unless otherwise indicated: $V_R = 1.8V$, $C_{OUT} = 1 \mu F$ Ceramic (X5R), $C_{IN} = 1 \mu F$ Ceramic (X5R), $I_L = 100 \mu A$, $T_A = +25^\circ C$, $V_{IN} = V_R + 1V$.

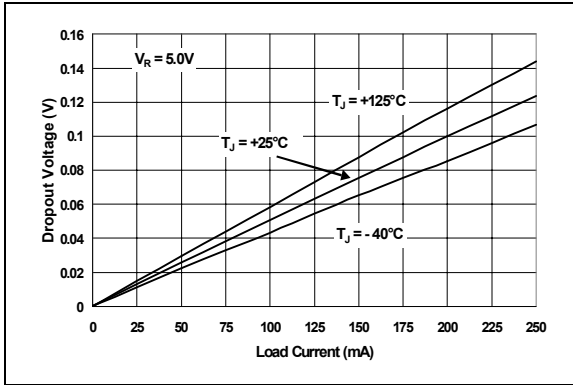

FIGURE 2-13: Dropout Voltage vs. Load Current ($V_R = 5.0V$).

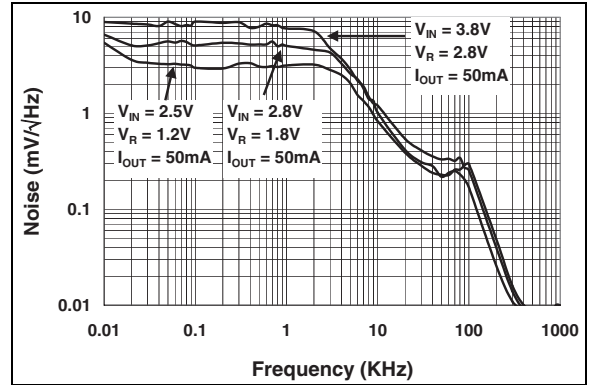

FIGURE 2-16: Noise vs. Frequency.

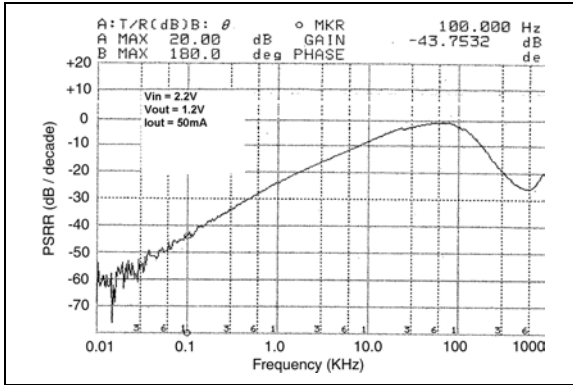

FIGURE 2-14: Power Supply Ripple Rejection vs. Frequency ($V_R = 1.2V$).

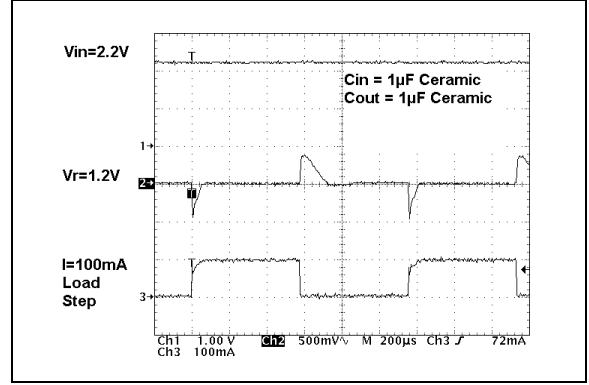

FIGURE 2-17: Dynamic Load Step ($V_R = 1.2V$).

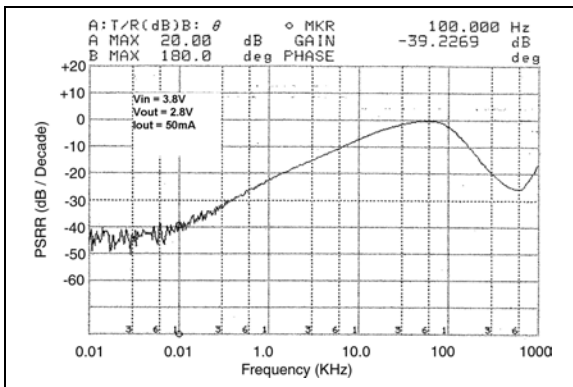

FIGURE 2-15: Power Supply Ripple Rejection vs. Frequency ($V_R = 2.8V$).

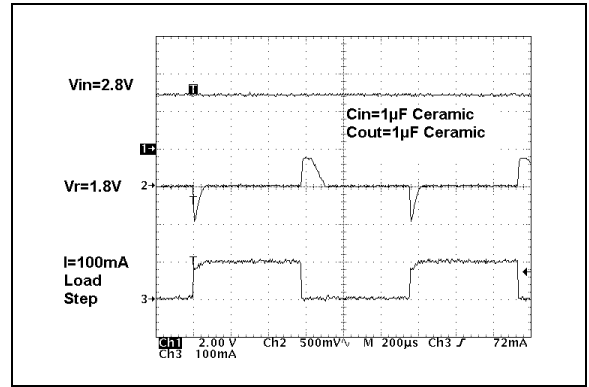

FIGURE 2-18: Dynamic Load Step ($V_R = 1.8V$).

MCP1700

Note: Unless otherwise indicated: $V_R = 1.8V$, $C_{OUT} = 1 \mu F$ Ceramic (X5R), $C_{IN} = 1 \mu F$ Ceramic (X5R), $I_L = 100 \mu A$, $T_A = +25^\circ C$, $V_{IN} = V_R + 1V$.

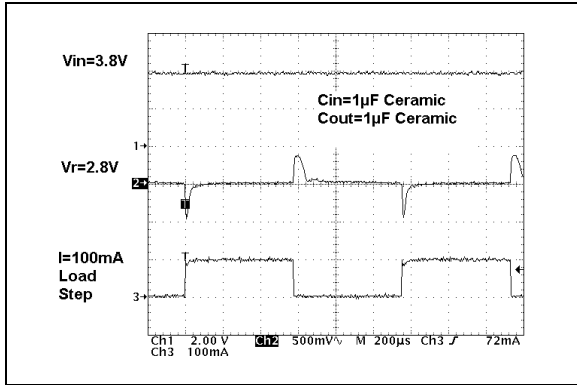

FIGURE 2-19: Dynamic Load Step ($V_R = 2.8V$).

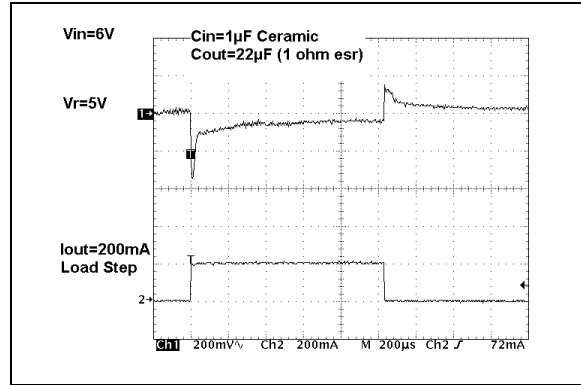

FIGURE 2-22: Dynamic Load Step ($V_R = 5.0V$).

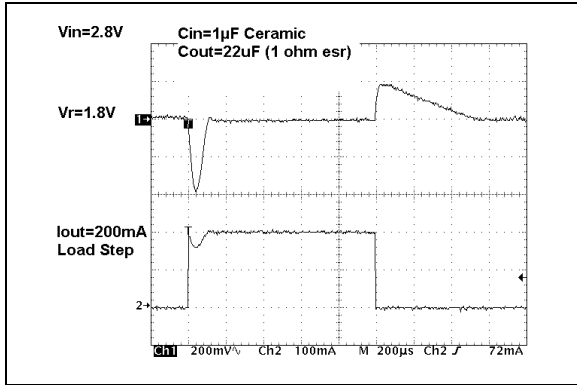

FIGURE 2-20: Dynamic Load Step ($V_R = 1.8V$).

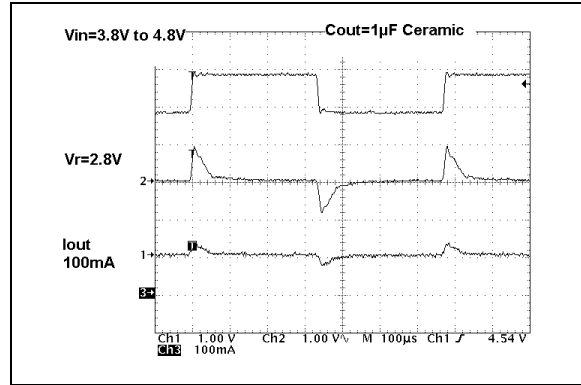

FIGURE 2-23: Dynamic Line Step ($V_R = 2.8V$).

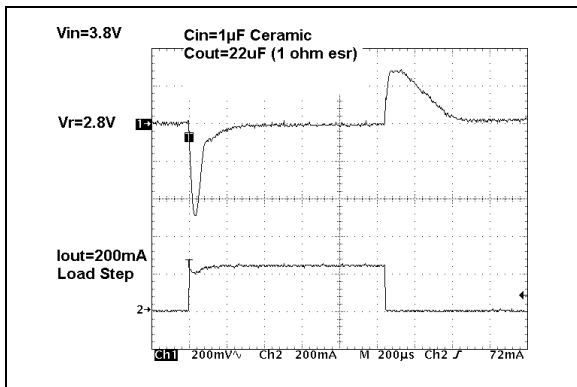

FIGURE 2-21: Dynamic Load Step ($V_R = 2.8V$).

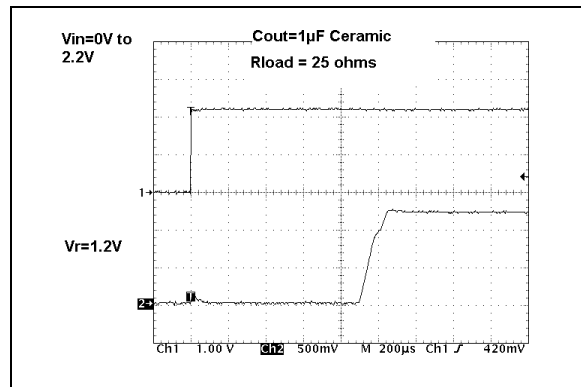

FIGURE 2-24: Startup From V_{IN} ($V_R = 1.2V$).

Note: Unless otherwise indicated: $V_R = 1.8V$, $C_{OUT} = 1 \mu F$ Ceramic (X5R), $C_{IN} = 1 \mu F$ Ceramic (X5R), $I_L = 100 \mu A$, $T_A = +25^\circ C$, $V_{IN} = V_R + 1V$.

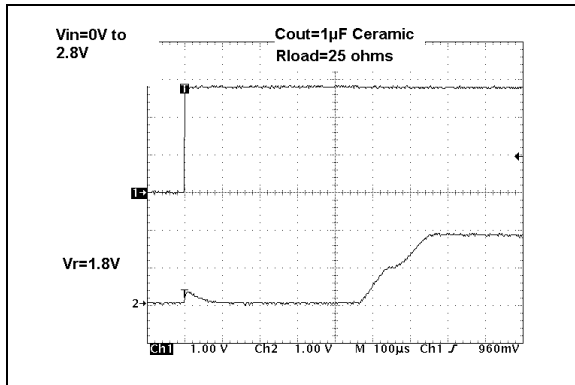

FIGURE 2-25: Start-up From V_{IN} ($V_R = 1.8V$).

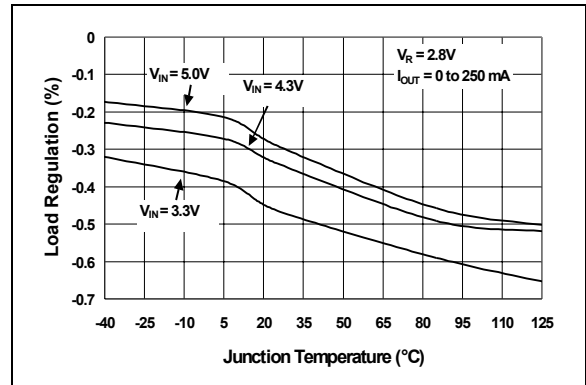

FIGURE 2-28: Load Regulation vs. Junction Temperature ($V_R = 2.8V$).

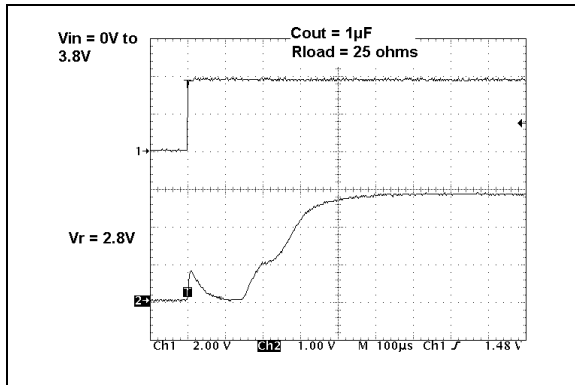

FIGURE 2-26: Start-up From V_{IN} ($V_R = 2.8V$).

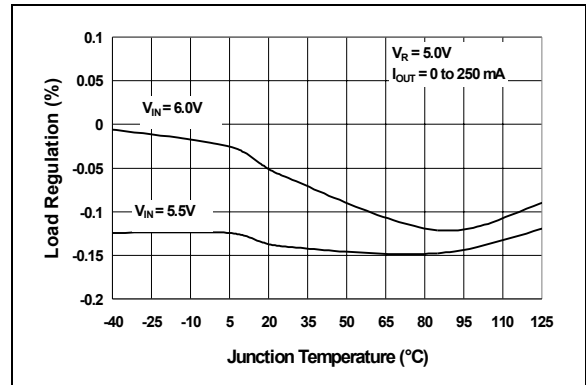

FIGURE 2-29: Load Regulation vs. Junction Temperature ($V_R = 5.0V$).

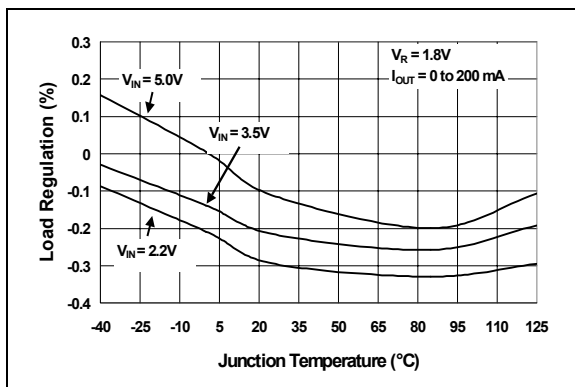

FIGURE 2-27: Load Regulation vs. Junction Temperature ($V_R = 1.8V$).

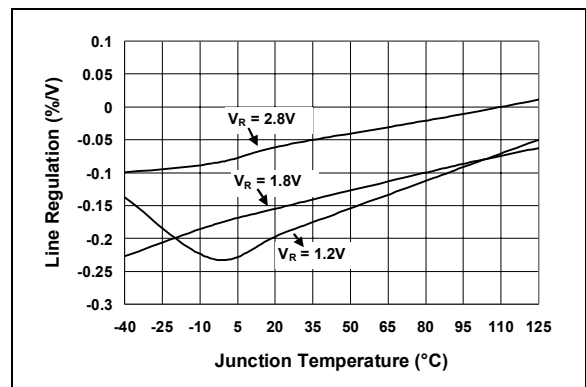

FIGURE 2-30: Line Regulation vs. Temperature ($V_R = 1.2V, 1.8V, 2.8V$).

MCP1700

3.0 MCP1700 PIN DESCRIPTIONS

The descriptions of the pins are listed in Table 3-1.

TABLE 3-1: MCP1700 PIN FUNCTION TABLE

Pin No. SOT23-A	Pin No. SOT89	Pin No. TO-92	Name	Function
1	1	1	GND	Ground Terminal
2	3	3	V _{OUT}	Regulated Voltage Output
3	2	2	V _{IN}	Unregulated Supply Voltage

3.1 Ground Terminal (GND)

Regulator ground. Tie GND to the negative side of the output and the negative side of the input capacitor. Only the LDO bias current (1.6 μ A typical) flows out of this pin; there is no high current. The LDO output regulation is referenced to this pin. Minimize voltage drops between this pin and the negative side of the load.

3.2 Regulated Output Voltage (V_{OUT})

Connect V_{OUT} to the positive side of the load and the positive terminal of the output capacitor. The positive side of the output capacitor should be physically located as close to the LDO V_{OUT} pin as is practical. The current flowing out of this pin is equal to the DC load current.

3.3 Unregulated Input Voltage Pin (V_{IN})

Connect V_{IN} to the input unregulated source voltage. Like all low dropout linear regulators, low source impedance is necessary for the stable operation of the LDO. The amount of capacitance required to ensure low source impedance will depend on the proximity of the input source capacitors or battery type. For most applications, 1 μ F of capacitance will ensure stable operation of the LDO circuit. For applications that have load currents below 100 mA, the input capacitance requirement can be lowered. The type of capacitor used can be ceramic, tantalum or aluminum electrolytic. The low ESR characteristics of the ceramic will yield better noise and PSRR performance at high-frequency.

4.0 DETAILED DESCRIPTION

4.1 Output Regulation

A portion of the LDO output voltage is fed back to the internal error amplifier and compared with the precision internal bandgap reference. The error amplifier output will adjust the amount of current that flows through the P-Channel pass transistor, thus regulating the output voltage to the desired value. Any changes in input voltage or output current will cause the error amplifier to respond and adjust the output voltage to the target voltage (refer to Figure 4-1).

4.2 Overcurrent

The MCP1700 internal circuitry monitors the amount of current flowing through the P-Channel pass transistor. In the event of a short-circuit or excessive output current, the MCP1700 will turn off the P-Channel device for a short period, after which the LDO will attempt to restart. If the excessive current remains, the cycle will repeat itself.

4.3 Overtemperature

The internal power dissipation within the LDO is a function of input-to-output voltage differential and load current. If the power dissipation within the LDO is excessive, the internal junction temperature will rise above the typical shutdown threshold of 140°C. At that point, the LDO will shut down and begin to cool to the typical turn-on junction temperature of 130°C. If the power dissipation is low enough, the device will continue to cool and operate normally. If the power dissipation remains high, the thermal shutdown protection circuitry will again turn off the LDO, protecting it from catastrophic failure.

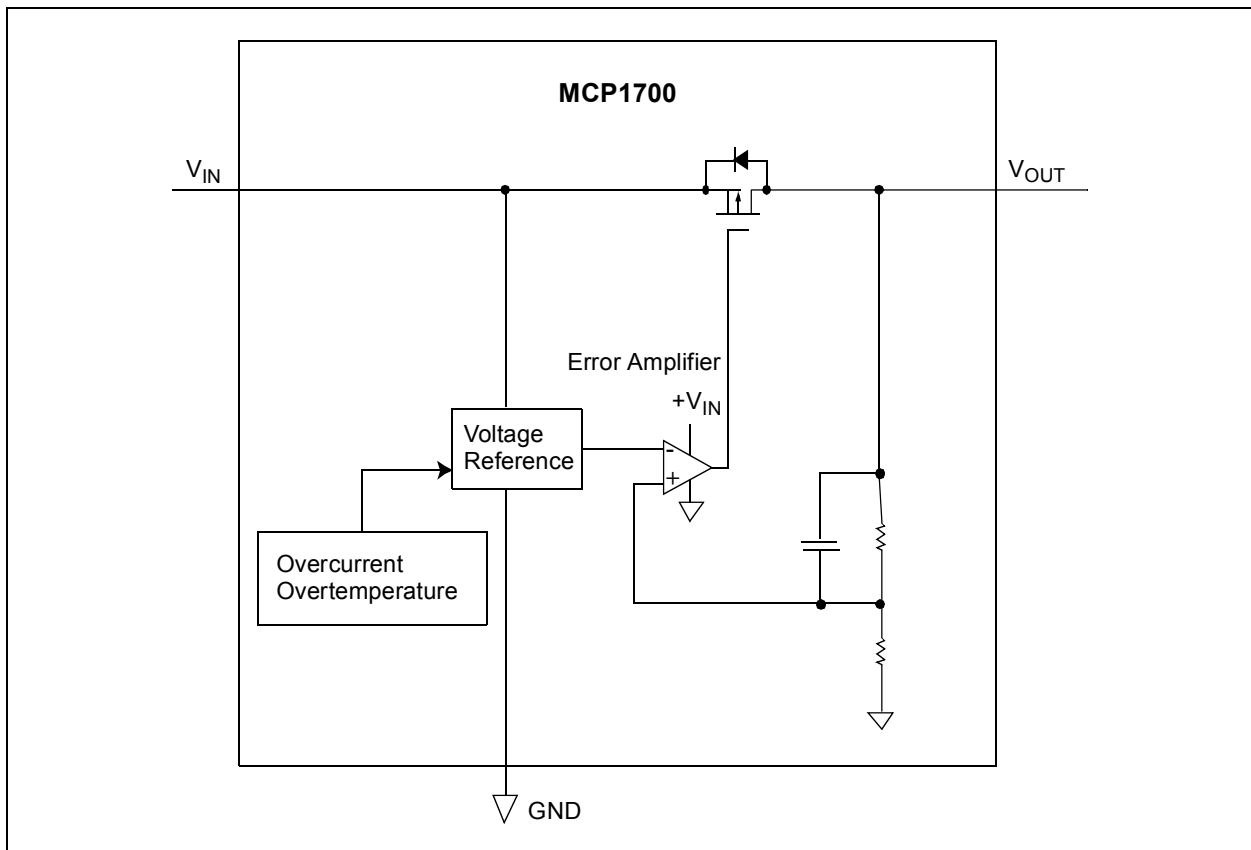

FIGURE 4-1: Block Diagram.

MCP1700

5.0 FUNCTIONAL DESCRIPTION

The MCP1700 CMOS low dropout linear regulator is intended for applications that need the lowest current consumption while maintaining output voltage regulation. The operating continuous load range of the MCP1700 is from 0 mA to 250 mA ($V_R \geq 2.5V$). The input operating voltage range is from 2.3V to 6.0V, making it capable of operating from two, three or four alkaline cells or a single Li-Ion cell battery input.

5.1 Input

The input of the MCP1700 is connected to the source of the P-Channel PMOS pass transistor. As with all LDO circuits, a relatively low source impedance (10Ω) is needed to prevent the input impedance from causing the LDO to become unstable. The size and type of the capacitor needed depends heavily on the input source type (battery, power supply) and the output current range of the application. For most applications (up to 100 mA), a 1 μF ceramic capacitor will be sufficient to ensure circuit stability. Larger values can be used to improve circuit AC performance.

5.2 Output

The maximum rated continuous output current for the MCP1700 is 250 mA ($V_R \geq 2.5V$). For applications where $V_R < 2.5V$, the maximum output current is 200 mA.

A minimum output capacitance of 1.0 μF is required for small signal stability in applications that have up to 250 mA output current capability. The capacitor type can be ceramic, tantalum or aluminum electrolytic. The esr range on the output capacitor can range from 0 Ω to 2.0 Ω .

5.3 Output Rise time

When powering up the internal reference output, the typical output rise time of 500 μs is controlled to prevent overshoot of the output voltage.

6.0 APPLICATION CIRCUITS & ISSUES

6.1 Typical Application

The MCP1700 is most commonly used as a voltage regulator. Its low quiescent current and low dropout voltage make it ideal for many battery-powered applications.

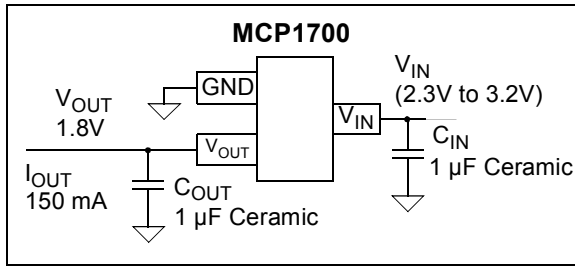

FIGURE 6-1: Typical Application Circuit.

6.1.1 APPLICATION INPUT CONDITIONS

Package Type = SOT23

Input Voltage Range = 2.3V to 3.2V

V_{IN} maximum = 3.2V

V_{OUT} typical = 1.8V

I_{OUT} = 150 mA maximum

6.2 Power Calculations

6.2.1 POWER DISSIPATION

The internal power dissipation of the MCP1700 is a function of input voltage, output voltage and output current. The power dissipation, as a result of the quiescent current draw, is so low, it is insignificant ($1.6 \mu A \times V_{IN}$). The following equation can be used to calculate the internal power dissipation of the LDO.

EQUATION

$$P_{LDO} = (V_{IN(MAX)} - V_{OUT(MIN)}) \times I_{OUT(MAX)}$$

P_{LDO} = LDO Pass device internal power dissipation

$V_{IN(MAX)}$ = Maximum input voltage

$V_{OUT(MIN)}$ = LDO minimum output voltage

The maximum continuous operating junction temperature specified for the MCP1700 is +125°C. To estimate the internal junction temperature of the MCP1700, the total internal power dissipation is multiplied by the thermal resistance from junction to ambient ($R\theta_{JA}$). The thermal resistance from junction to ambient for the SOT23 pin package is estimated at 230 °C/W.

EQUATION

$$T_{J(MAX)} = P_{TOTAL} \times R\theta_{JA} + T_{AMAX}$$

$T_{J(MAX)}$ = Maximum continuous junction temperature.

P_{TOTAL} = Total device power dissipation.

$R\theta_{JA}$ = Thermal resistance from junction to ambient.

T_{AMAX} = Maximum ambient temperature.

The maximum power dissipation capability for a package can be calculated given the junction-to-ambient thermal resistance and the maximum ambient temperature for the application. The following equation can be used to determine the package maximum internal power dissipation.

EQUATION

$$P_{D(MAX)} = \frac{(T_{J(MAX)} - T_{A(MAX)})}{R\theta_{JA}}$$

$P_{D(MAX)}$ = Maximum device power dissipation.

$T_{J(MAX)}$ = Maximum continuous junction temperature.

$T_{A(MAX)}$ = Maximum ambient temperature.

$R\theta_{JA}$ = Thermal resistance from junction to ambient.

EQUATION

$$T_{J(RISE)} = P_{D(MAX)} \times R\theta_{JA}$$

$T_{J(RISE)}$ = Rise in device junction temperature over the ambient temperature.

P_{TOTAL} = Maximum device power dissipation.

$R\theta_{JA}$ = Thermal resistance from junction to ambient.

EQUATION

$$T_J = T_{J(RISE)} + T_A$$

T_J = Junction Temperature.

$T_{J(RISE)}$ = Rise in device junction temperature over the ambient temperature.

T_A = Ambient temperature.

MCP1700

6.3 Voltage Regulator

Internal power dissipation, junction temperature rise, junction temperature and maximum power dissipation are calculated in the following example. The power dissipation, as a result of ground current, is small enough to be neglected.

6.3.1 POWER DISSIPATION EXAMPLE

Package

Package Type = SOT23

Input Voltage

$$V_{IN} = 2.3V \text{ to } 3.2V$$

LDO Output Voltages and Currents

$$V_{OUT} = 1.8V$$

$$I_{OUT} = 150 \text{ mA}$$

Maximum Ambient Temperature

$$T_{A(MAX)} = +40^{\circ}C$$

Internal Power Dissipation

Internal Power dissipation is the product of the LDO output current times the voltage across the LDO (V_{IN} to V_{OUT}).

$$P_{LDO(MAX)} = (V_{IN(MAX)} - V_{OUT(MIN)}) \times I_{OUT(MAX)}$$

$$P_{LDO} = (3.2V - (0.97 \times 1.8V)) \times 150 \text{ mA}$$

$$P_{LDO} = 218.1 \text{ milli-Watts}$$

Device Junction Temperature Rise

The internal junction temperature rise is a function of internal power dissipation and the thermal resistance from junction to ambient for the application. The thermal resistance from junction to ambient ($R_{\theta JA}$) is derived from an EIA/JEDEC standard for measuring thermal resistance for small surface mount packages. The EIA/JEDEC specification is JESD51-7, "High Effective Thermal Conductivity Test Board for Leaded Surface Mount Packages". The standard describes the test method and board specifications for measuring the thermal resistance from junction to ambient. The actual thermal resistance for a particular application can vary depending on many factors, such as copper area and thickness. Refer to AN792, "A Method to Determine How Much Power a SOT23 Can Dissipate in an Application", (DS00792), for more information regarding this subject.

$$T_{J(RISE)} = P_{TOTAL} \times R_{\theta JA}$$

$$T_{JRISE} = 218.1 \text{ milli-Watts} \times 230.0^{\circ}C/Watt$$

$$T_{JRISE} = 50.2^{\circ}C$$

Junction Temperature Estimate

To estimate the internal junction temperature, the calculated temperature rise is added to the ambient or offset temperature. For this example, the worst-case junction temperature is estimated below.

$$T_J = T_{JRISE} + T_{A(MAX)}$$

$$T_J = 90.2^{\circ}C$$

Maximum Package Power Dissipation at +40°C Ambient Temperature

SOT23 ($230.0^{\circ}C/Watt = R_{\theta JA}$)

$$P_{D(MAX)} = (125^{\circ}C - 40^{\circ}C) / 230^{\circ}C/W$$

$$P_{D(MAX)} = 369.6 \text{ milli-Watts}$$

SOT89 ($52^{\circ}C/Watt = R_{\theta JA}$)

$$P_{D(MAX)} = (125^{\circ}C - 40^{\circ}C) / 52^{\circ}C/W$$

$$P_{D(MAX)} = 1.635 \text{ Watts}$$

TO92 ($131.9^{\circ}C/Watt = R_{\theta JA}$)

$$P_{D(MAX)} = (125^{\circ}C - 40^{\circ}C) / 131.9^{\circ}C/W$$

$$P_{D(MAX)} = 644 \text{ milli-Watts}$$

6.4 Voltage Reference

The MCP1700 can be used not only as a regulator, but also as a low quiescent current voltage reference. In many microcontroller applications, the initial accuracy of the reference can be calibrated using production test equipment or by using a ratio measurement. When the initial accuracy is calibrated, the thermal stability and line regulation tolerance are the only errors introduced by the MCP1700 LDO. The low cost, low quiescent current and small ceramic output capacitor are all advantages when using the MCP1700 as a voltage reference.

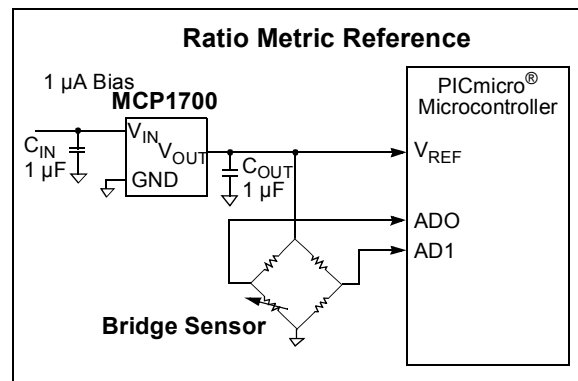

FIGURE 6-2: Using the MCP1700 as a voltage reference.

6.5 Pulsed Load Applications

For some applications, there are pulsed load current events that may exceed the specified 250 mA maximum specification of the MCP1700. The internal current limit of the MCP1700 will prevent high peak load demands from causing non-recoverable damage. The 250 mA rating is a maximum average continuous rating. As long as the average current does not exceed 250 mA, pulsed higher load currents can be applied to the MCP1700. The typical current limit for the MCP1700 is 550 mA ($T_A + 25^{\circ}C$).

7.0 PACKAGING INFORMATION

7.1 Package Marking Information

3-Pin SOT-23A

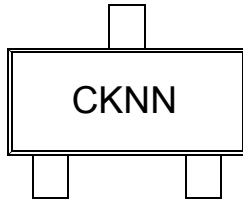

3-Pin SOT-89

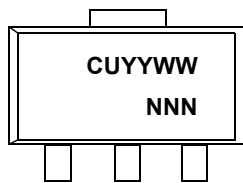

Standard	
Extended Temp	
Symbol	Voltage *
CK	1.2
CM	1.8
CP	2.5
CR	3.0
CS	3.3
CU	5.0

* Custom output voltages available upon request.
Contact your local Microchip sales office for more information.

3-Pin TO-92

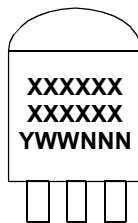

Example:

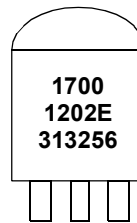

Legend:	XX...X	Customer specific information*
	Y	Year code (last digit of calendar year)
	YY	Year code (last 2 digits of calendar year)
	WW	Week code (week of January 1 is week '01')
	NNN	Alphanumeric traceability code
Note:	In the event the full Microchip part number cannot be marked on one line, it will be carried over to the next line thus limiting the number of available characters for customer specific information.	

* Standard device marking consists of Microchip part number, year code, week code, and traceability code.

MCP1700

3-Lead Plastic Small Outline Transistor (TT) (SOT-23)

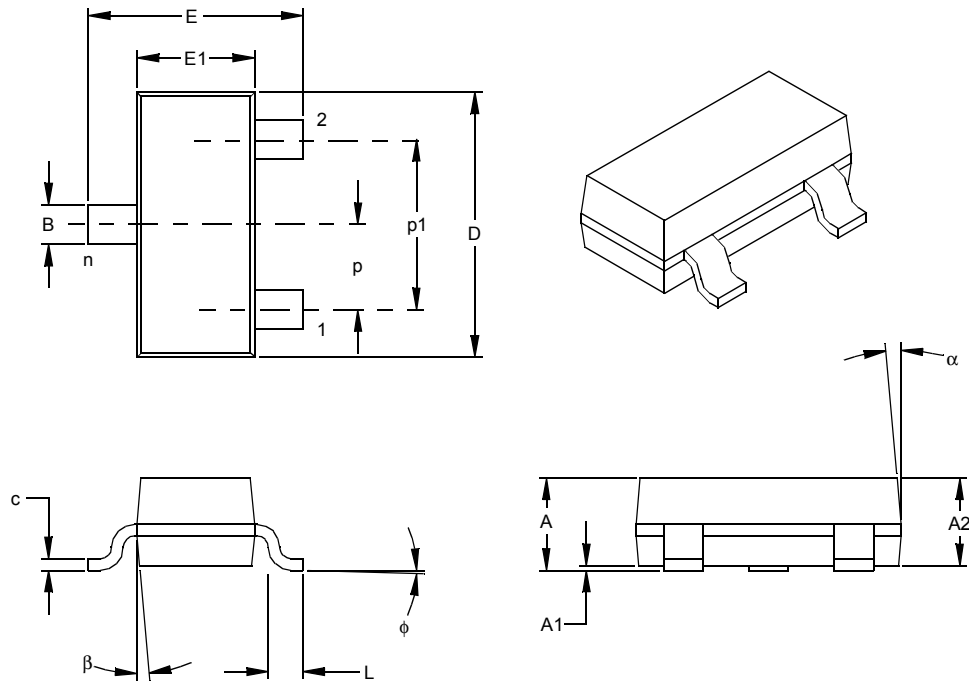

Units		INCHES*			MILLIMETERS		
Dimension Limits		MIN	NOM	MAX	MIN	NOM	MAX
Number of Pins	n		3			3	
Pitch	p		.038			0.96	
Outside lead pitch (basic)	p1		.076			1.92	
Overall Height	A	.035	.040	.044	0.89	1.01	1.12
Molded Package Thickness	A2	.035	.037	.040	0.88	0.95	1.02
Standoff §	A1	.000	.002	.004	0.01	0.06	0.10
Overall Width	E	.083	.093	.104	2.10	2.37	2.64
Molded Package Width	E1	.047	.051	.055	1.20	1.30	1.40
Overall Length	D	.110	.115	.120	2.80	2.92	3.04
Foot Length	L	.014	.018	.022	0.35	0.45	0.55
Foot Angle	φ	0	5	10	0	5	10
Lead Thickness	c	.004	.006	.007	0.09	0.14	0.18
Lead Width	B	.015	.017	.020	0.37	0.44	0.51
Mold Draft Angle Top	α	0	5	10	0	5	10
Mold Draft Angle Bottom	β	0	5	10	0	5	10

* Controlling Parameter
 § Significant Characteristic

Notes:

Dimensions D and E1 do not include mold flash or protrusions. Mold flash or protrusions shall not exceed .010" (0.254mm) per side.

JEDEC Equivalent: TO-236

Drawing No. C04-104

3-Lead Plastic Small Outline Transistor Header (MB) (SOT-89)

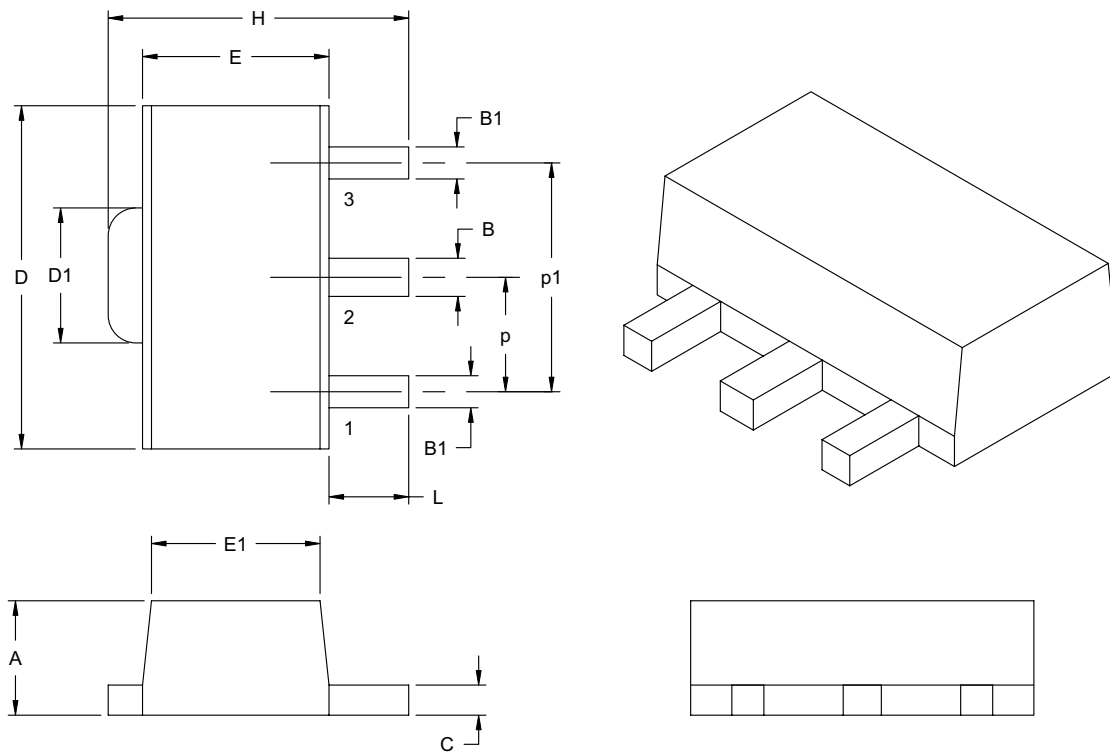

Dimension Limits	Units	INCHES		MILLIMETERS*	
		MIN	MAX	MIN	MAX
Pitch	p	.059 BSC		1.50 BSC	
Outside lead pitch (basic)	p1	.118 BSC		3.00 BSC	
Overall Height	A	.055	.063	1.40	1.60
Overall Width	H	.155	.167	3.94	4.25
Molded Package Width at Base	E	.090	.102	2.29	2.60
Molded Package Width at Top	E1	.084	.090	2.13	2.29
Overall Length	D	.173	.181	4.40	4.60
Tab Length	D1	.064	.072	1.62	1.83
Foot Length	L	.035	.047	0.89	1.20
Lead Thickness	c	.014	.017	0.35	0.44
Lead 2 Width	B	.017	.022	0.44	0.56
Leads 1 & 3 Width	B1	.014	.019	0.36	0.48

*Controlling Parameter

Notes:

Dimensions D and E1 do not include mold flash or protrusions. Mold flash or protrusions shall not exceed .005" (0.127mm) per side.

JEDEC Equivalent: TO-243

Drawing No. C04-29

MCP1700

3-Lead Plastic Transistor Outline (TO) (TO-92)

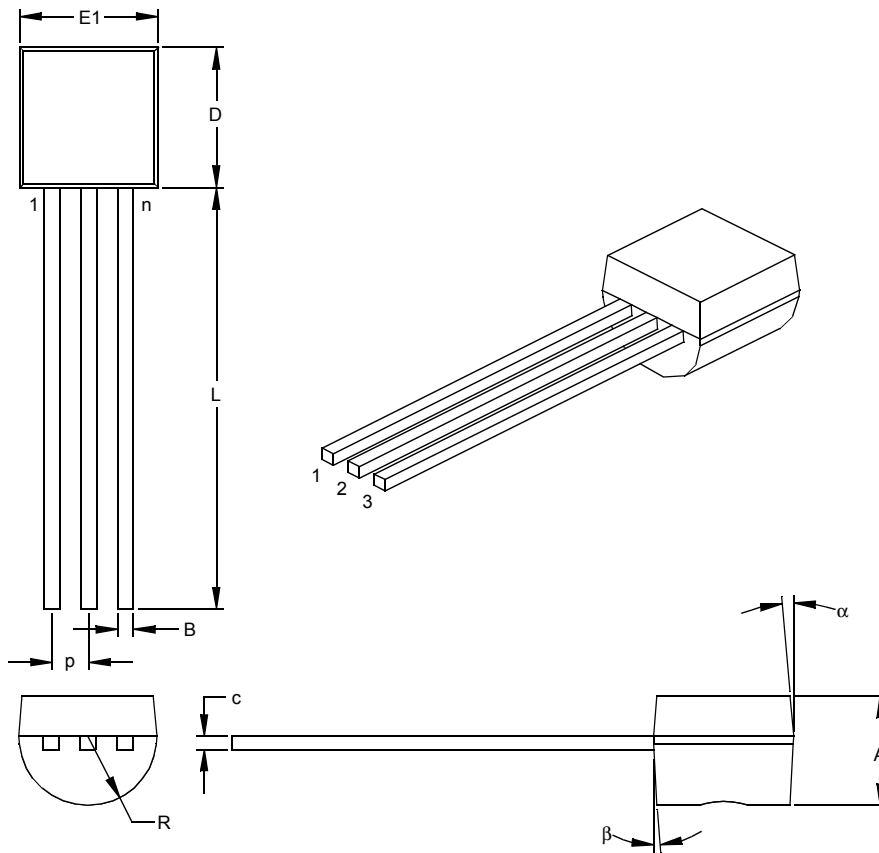

Dimension Limits	Units	INCHES*			MILLIMETERS		
		MIN	NOM	MAX	MIN	NOM	MAX
Number of Pins	n		3			3	
Pitch	p		.050			1.27	
Bottom to Package Flat	A	.130	.143	.155	3.30	3.62	3.94
Overall Width	E1	.175	.186	.195	4.45	4.71	4.95
Overall Length	D	.170	.183	.195	4.32	4.64	4.95
Molded Package Radius	R	.085	.090	.095	2.16	2.29	2.41
Tip to Seating Plane	L	.500	.555	.610	12.70	14.10	15.49
Lead Thickness	c	.014	.017	.020	0.36	0.43	0.51
Lead Width	B	.016	.019	.022	0.41	0.48	0.56
Mold Draft Angle Top	α	4	5	6	4	5	6
Mold Draft Angle Bottom	β	2	3	4	2	3	4

*Controlling Parameter

Notes:

Dimensions D and E1 do not include mold flash or protrusions. Mold flash or protrusions shall not exceed .010" (0.254mm) per side.

JEDEC Equivalent: TO-92

Drawing No. C04-101

PRODUCT IDENTIFICATION SYSTEM

To order or obtain information, e.g., on pricing or delivery, refer to the factory or the listed sales office.

<u>PART NO.</u>	<u>X-</u>	<u>XXX</u>	<u>X</u>	<u>X</u>	<u>XX</u>						
MCP1700	Tape & Reel	Voltage Output	Tolerance	Temp. Range	Package						
Device: MCP1700: Low Quiescent Current LDO											
Tape and Reel: Tape and Reel only applies to SOT-23 and SOT-89 devices											
Standard Output Voltage: * <table style="margin-left: 20px;"> <tr><td>120 = 1.2V</td></tr> <tr><td>180 = 1.8V</td></tr> <tr><td>250 = 2.5V</td></tr> <tr><td>300 = 3.0V</td></tr> <tr><td>330 = 3.3V</td></tr> <tr><td>500 = 5.0V</td></tr> </table> <p style="margin-left: 40px;">* Custom output voltages available upon request. Contact your local Microchip sales office for more information</p>						120 = 1.2V	180 = 1.8V	250 = 2.5V	300 = 3.0V	330 = 3.3V	500 = 5.0V
120 = 1.2V											
180 = 1.8V											
250 = 2.5V											
300 = 3.0V											
330 = 3.3V											
500 = 5.0V											
Tolerance: 2 = 2%											
Temperature Range: E = -40°C to +125°C (Extended)											
Package: <table style="margin-left: 20px;"> <tr><td>TO = 3-lead TO-92</td></tr> <tr><td>MB = 3-lead SOT89</td></tr> <tr><td>TT = 3-lead SOT23</td></tr> </table>						TO = 3-lead TO-92	MB = 3-lead SOT89	TT = 3-lead SOT23			
TO = 3-lead TO-92											
MB = 3-lead SOT89											
TT = 3-lead SOT23											
Examples:											
TO-92 Package: <table style="margin-left: 20px;"> <tr><td>a) MCP1700-1202E/TO: 1.2V V_{OUT}</td></tr> <tr><td>b) MCP1700-1802E/TO: 1.8V V_{OUT}</td></tr> <tr><td>c) MCP1700-2502E/TO: 2.5V V_{OUT}</td></tr> <tr><td>d) MCP1700-3002E/TO: 3.0V V_{OUT}</td></tr> <tr><td>e) MCP1700-3302E/TO: 3.3V V_{OUT}</td></tr> <tr><td>f) MCP1700-5002E/TO: 5.0V V_{OUT}</td></tr> </table>						a) MCP1700-1202E/TO: 1.2V V _{OUT}	b) MCP1700-1802E/TO: 1.8V V _{OUT}	c) MCP1700-2502E/TO: 2.5V V _{OUT}	d) MCP1700-3002E/TO: 3.0V V _{OUT}	e) MCP1700-3302E/TO: 3.3V V _{OUT}	f) MCP1700-5002E/TO: 5.0V V _{OUT}
a) MCP1700-1202E/TO: 1.2V V _{OUT}											
b) MCP1700-1802E/TO: 1.8V V _{OUT}											
c) MCP1700-2502E/TO: 2.5V V _{OUT}											
d) MCP1700-3002E/TO: 3.0V V _{OUT}											
e) MCP1700-3302E/TO: 3.3V V _{OUT}											
f) MCP1700-5002E/TO: 5.0V V _{OUT}											
SOT89 Package: <table style="margin-left: 20px;"> <tr><td>a) MCP1700T-1202E/MB: 1.2V V_{OUT}</td></tr> <tr><td>b) MCP1700T-1802E/MB: 1.8V V_{OUT}</td></tr> <tr><td>c) MCP1700T-2502E/MB: 2.5V V_{OUT}</td></tr> <tr><td>d) MCP1700T-3002E/MB: 3.0V V_{OUT}</td></tr> <tr><td>e) MCP1700T-3302E/MB: 3.3V V_{OUT}</td></tr> <tr><td>f) MCP1700T-5002E/MB: 5.0V V_{OUT}</td></tr> </table>						a) MCP1700T-1202E/MB: 1.2V V _{OUT}	b) MCP1700T-1802E/MB: 1.8V V _{OUT}	c) MCP1700T-2502E/MB: 2.5V V _{OUT}	d) MCP1700T-3002E/MB: 3.0V V _{OUT}	e) MCP1700T-3302E/MB: 3.3V V _{OUT}	f) MCP1700T-5002E/MB: 5.0V V _{OUT}
a) MCP1700T-1202E/MB: 1.2V V _{OUT}											
b) MCP1700T-1802E/MB: 1.8V V _{OUT}											
c) MCP1700T-2502E/MB: 2.5V V _{OUT}											
d) MCP1700T-3002E/MB: 3.0V V _{OUT}											
e) MCP1700T-3302E/MB: 3.3V V _{OUT}											
f) MCP1700T-5002E/MB: 5.0V V _{OUT}											
SOT23 Package: <table style="margin-left: 20px;"> <tr><td>a) MCP1700T-1202E/TT: 1.2V V_{OUT}</td></tr> <tr><td>b) MCP1700T-1802E/TT: 1.8V V_{OUT}</td></tr> <tr><td>c) MCP1700T-2502E/TT: 2.5V V_{OUT}</td></tr> <tr><td>d) MCP1700T-3002E/TT: 3.0V V_{OUT}</td></tr> <tr><td>e) MCP1700T-3302E/TT: 3.3V V_{OUT}</td></tr> <tr><td>f) MCP1700T-5002E/TT: 5.0V V_{OUT}</td></tr> </table>						a) MCP1700T-1202E/TT: 1.2V V _{OUT}	b) MCP1700T-1802E/TT: 1.8V V _{OUT}	c) MCP1700T-2502E/TT: 2.5V V _{OUT}	d) MCP1700T-3002E/TT: 3.0V V _{OUT}	e) MCP1700T-3302E/TT: 3.3V V _{OUT}	f) MCP1700T-5002E/TT: 5.0V V _{OUT}
a) MCP1700T-1202E/TT: 1.2V V _{OUT}											
b) MCP1700T-1802E/TT: 1.8V V _{OUT}											
c) MCP1700T-2502E/TT: 2.5V V _{OUT}											
d) MCP1700T-3002E/TT: 3.0V V _{OUT}											
e) MCP1700T-3302E/TT: 3.3V V _{OUT}											
f) MCP1700T-5002E/TT: 5.0V V _{OUT}											

Sales and Support

Data Sheets

Products supported by a preliminary Data Sheet may have an errata sheet describing minor operational differences and recommended workarounds. To determine if an errata sheet exists for a particular device, please contact one of the following:

1. Your local Microchip sales office
2. The Microchip Corporate Literature Center U.S. FAX: (480) 792-7277
3. The Microchip Worldwide Site (www.microchip.com)

Please specify which device, revision of silicon and Data Sheet (include Literature #) you are using.

Customer Notification System

Register on our web site (www.microchip.com/cn) to receive the most current information on our products.

MCP1700

NOTES:

Note the following details of the code protection feature on Microchip devices:

- Microchip products meet the specification contained in their particular Microchip Data Sheet.
- Microchip believes that its family of products is one of the most secure families of its kind on the market today, when used in the intended manner and under normal conditions.
- There are dishonest and possibly illegal methods used to breach the code protection feature. All of these methods, to our knowledge, require using the Microchip products in a manner outside the operating specifications contained in Microchip's Data Sheets. Most likely, the person doing so is engaged in theft of intellectual property.
- Microchip is willing to work with the customer who is concerned about the integrity of their code.
- Neither Microchip nor any other semiconductor manufacturer can guarantee the security of their code. Code protection does not mean that we are guaranteeing the product as "unbreakable."

Code protection is constantly evolving. We at Microchip are committed to continuously improving the code protection features of our products. Attempts to break microchip's code protection feature may be a violation of the Digital Millennium Copyright Act. If such acts allow unauthorized access to your software or other copyrighted work, you may have a right to sue for relief under that Act.

Information contained in this publication regarding device applications and the like is intended through suggestion only and may be superseded by updates. It is your responsibility to ensure that your application meets with your specifications. No representation or warranty is given and no liability is assumed by Microchip Technology Incorporated with respect to the accuracy or use of such information, or infringement of patents or other intellectual property rights arising from such use or otherwise. Use of Microchip's products as critical components in life support systems is not authorized except with express written approval by Microchip. No licenses are conveyed, implicitly or otherwise, under any intellectual property rights.

Trademarks

The Microchip name and logo, the Microchip logo, Accuron, dsPIC, KEELOQ, MPLAB, PIC, PICmicro, PICSTART, PRO MATE and PowerSmart are registered trademarks of Microchip Technology Incorporated in the U.S.A. and other countries.

AmpLab, FilterLab, microID, MXDEV, MXLAB, PICMASTER, SEEVAL and The Embedded Control Solutions Company are registered trademarks of Microchip Technology Incorporated in the U.S.A.

Application Maestro, dsPICDEM, dsPICDEM.net, ECAN, ECONOMONITOR, FanSense, FlexROM, fuzzyLAB, In-Circuit Serial Programming, ICSP, ICEPIC, microPort, Migratable Memory, MPASM, MPLIB, MPLINK, MPSIM, PICkit, PICDEM, PICDEM.net, PowerCal, PowerInfo, PowerMate, PowerTool, rLAB, rfPIC, Select Mode, SmartSensor, SmartShunt, SmartTel and Total Endurance are trademarks of Microchip Technology Incorporated in the U.S.A. and other countries.

Serialized Quick Turn Programming (SQTP) is a service mark of Microchip Technology Incorporated in the U.S.A.

All other trademarks mentioned herein are property of their respective companies.

© 2003, Microchip Technology Incorporated, Printed in the U.S.A., All Rights Reserved.

 Printed on recycled paper.

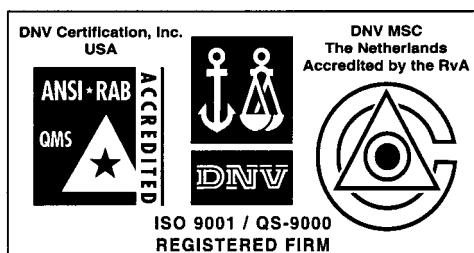

Microchip received QS-9000 quality system certification for its worldwide headquarters, design and wafer fabrication facilities in Chandler and Tempe, Arizona in July 1999 and Mountain View, California in March 2002. The Company's quality system processes and procedures are QS-9000 compliant for its PICmicro® 8-bit MCUs, KEELOQ® code hopping devices, Serial EEPROMs, microperipherals, non-volatile memory and analog products. In addition, Microchip's quality system for the design and manufacture of development systems is ISO 9001 certified.



WORLDWIDE SALES AND SERVICE

AMERICAS

Corporate Office

2355 West Chandler Blvd.
Chandler, AZ 85224-6199
Tel: 480-792-7200
Fax: 480-792-7277
Technical Support: 480-792-7627
Web Address: <http://www.microchip.com>

Atlanta

3780 Mansell Road, Suite 130
Alpharetta, GA 30022
Tel: 770-640-0034
Fax: 770-640-0307

Boston

2 Lan Drive, Suite 120
Westford, MA 01886
Tel: 978-692-3848
Fax: 978-692-3821

Chicago

333 Pierce Road, Suite 180
Itasca, IL 60143
Tel: 630-285-0071
Fax: 630-285-0075

Dallas

4570 Westgrove Drive, Suite 160
Addison, TX 75001
Tel: 972-818-7423
Fax: 972-818-2924

Detroit

Tri-Atria Office Building
32255 Northwestern Highway, Suite 190
Farmington Hills, MI 48334
Tel: 248-538-2250
Fax: 248-538-2260

Kokomo

2767 S. Albright Road
Kokomo, IN 46902
Tel: 765-864-8360
Fax: 765-864-8387

Los Angeles

18201 Von Karman, Suite 1090
Irvine, CA 92612
Tel: 949-263-1888
Fax: 949-263-1338

Phoenix

2355 West Chandler Blvd.
Chandler, AZ 85224-6199
Tel: 480-792-7966
Fax: 480-792-4338

San Jose

2107 North First Street, Suite 590
San Jose, CA 95131
Tel: 408-436-7950
Fax: 408-436-7955

Toronto

6285 Northam Drive, Suite 108
Mississauga, Ontario L4V 1X5, Canada
Tel: 905-673-0699
Fax: 905-673-6509

ASIA/PACIFIC

Australia

Suite 22, 41 Rawson Street
Epping 2121, NSW
Australia
Tel: 61-2-9868-6733
Fax: 61-2-9868-6755

China - Beijing

Unit 915
Bei Hai Wan Tai Bldg.
No. 6 Chaoyangmen Beidajie
Beijing, 100027, No. China
Tel: 86-10-85282100
Fax: 86-10-85282104

China - Chengdu

Rm. 2401-2402, 24th Floor,
Ming Xing Financial Tower
No. 88 TIDU Street
Chengdu 610016, China
Tel: 86-28-86766200
Fax: 86-28-86766599

China - Fuzhou

Unit 28F, World Trade Plaza
No. 71 Wusi Road
Fuzhou 350001, China
Tel: 86-591-7503506
Fax: 86-591-7503521

China - Hong Kong SAR

Unit 901-6, Tower 2, Metroplaza
223 Hing Fong Road
Kwai Fong, N.T., Hong Kong
Tel: 852-2401-1200
Fax: 852-2401-3431

China - Shanghai

Room 701, Bldg. B
Far East International Plaza
No. 317 Xian Xia Road
Shanghai, 200051
Tel: 86-21-6275-5700
Fax: 86-21-6275-5060

China - Shenzhen

Rm. 1812, 18/F, Building A, United Plaza
No. 5022 Binhe Road, Futian District
Shenzhen 518033, China
Tel: 86-755-82901380
Fax: 86-755-8295-1393

China - Shunde

Room 401, Hongjian Building
No. 2 Fengxiangnan Road, Ronggui Town
Shunde City, Guangdong 528303, China
Tel: 86-765-8395507 Fax: 86-765-8395571

China - Qingdao

Rm. B505A, Fullhope Plaza,
No. 12 Hong Kong Central Rd.
Qingdao 266071, China
Tel: 86-532-5027355 Fax: 86-532-5027205

India

Divyasree Chambers
1 Floor, Wing A (A3/A4)
No. 11, O'Shaughnessy Road
Bangalore, 560 025, India
Tel: 91-80-2290061 Fax: 91-80-2290062

Japan

Benex S-1 6F
3-18-20, Shinyokohama
Kohoku-Ku, Yokohama-shi
Kanagawa, 222-0033, Japan
Tel: 81-45-471-6166 Fax: 81-45-471-6122

Korea

168-1, Youngbo Bldg. 3 Floor
Samsung-Dong, Kangnam-Ku
Seoul, Korea 135-882
Tel: 82-2-554-7200 Fax: 82-2-558-5932 or
82-2-558-5934

Singapore

200 Middle Road
#07-02 Prime Centre
Singapore, 188980
Tel: 65-6334-8870 Fax: 65-6334-8850

Taiwan

Kaohsiung Branch
30F - 1 No. 8
Min Chuan 2nd Road
Kaohsiung 806, Taiwan
Tel: 886-7-536-4818
Fax: 886-7-536-4803

Taiwan

Taiwan Branch
11F-3, No. 207
Tung Hua North Road
Taipei, 105, Taiwan
Tel: 886-2-2717-7175 Fax: 886-2-2545-0139

EUROPE

Austria

Durisolstrasse 2
A-4600 Wels
Austria
Tel: 43-7242-2244-399
Fax: 43-7242-2244-393

Denmark

Regus Business Centre
Lautrup høj 1-3
Ballerup DK-2750 Denmark
Tel: 45-4420-9895 Fax: 45-4420-9910

France

Parc d'Activite du Moulin de Massy
43 Rue du Saule Trapu
Batiment A - ler Etage
91300 Massy, France
Tel: 33-1-69-53-63-20
Fax: 33-1-69-30-90-79

Germany

Steinheilstrasse 10
D-85737 Ismaning, Germany
Tel: 49-89-627-144-0
Fax: 49-89-627-144-44

Italy

Via Quasimodo, 12
20025 Legnano (MI)
Milan, Italy
Tel: 39-0331-742611
Fax: 39-0331-466781

Netherlands

P. A. De Biesbosch 14
NL-5152 SC Drunen, Netherlands
Tel: 31-416-690399
Fax: 31-416-690340

United Kingdom

505 Eskdale Road
Winnersh Triangle
Wokingham
Berkshire, England RG41 5TU
Tel: 44-118-921-5869
Fax: 44-118-921-5820

07/28/03