

# DATA SHEET

**TDA1526**

**Stereo-tone/volume control circuit**

Product specification  
File under Integrated Circuits, IC01

May 1992

## Stereo-tone/volume control circuit

## TDA1526

## GENERAL DESCRIPTION

The device is designed as an active stereo-tone/volume control for car radios, TV receivers and mains-fed equipment. It includes functions for bass and treble control, volume control with built-in contour (can be switched off) and balance. All these functions can be controlled by DC voltages or by single linear potentiometers.

## Features

- Few external components necessary
- Low noise due to internal gain
- Bass emphasis can be increased by a double-pole low-pass filter
- Wide power supply voltage range.

## QUICK REFERENCE DATA

PARAMETER	CONDITIONS	SYMBOL	MIN.	TYP.	MAX.	UNIT
Supply voltage (pin 3)		$V_P$	7.5	12	16.5	V
Supply current (pin 3)	$V_P = 12\text{ V}$	$I_P$	25	35	45	mA
<b>Signal handling with DC feedback</b>	$V_P = 8.5\text{ to }15\text{ V}$ ; THD = 0.7%; $f = 1\text{ kHz}$					
Input signal handling (RMS value)		$V_i(\text{rms})$	1.8	2.0	–	V
Output signal handling (RMS value)	notes 2 and 3	$V_o(\text{rms})$	1.8	2.0	–	V
<b>Control range</b>						
Maximum gain of volume	see Fig.4	$G_{V\text{ max}}$	20.5	21.5	23	dB
Volume control range	$G_{V\text{ max}}/G_{V\text{ min}}$	$\Delta G_V$	90	100	–	dB
Balance control range	$G_V = 0\text{ dB}$ ; see Fig.5	$\Delta G_V$	–	–40	–	dB
Bass control range	at 40 Hz; see Fig.6	$\Delta G_V$	–	–19 to +17 $\pm 3$	–	dB
Treble control range	at 16 kHz; see Fig.7	$\Delta G_V$	–	$\pm 15 \pm 3$	–	dB
Total harmonic distortion		THD	–	–	0.5	%
<b>Noise performance</b>	$V_P = 12\text{ V}$					
Output noise voltage (unweighted) at $f = 20\text{ Hz to }20\text{ kHz}$ for $G_V = -16\text{ dB}$	RMS value; note 4 note 5	$V_{\text{no}}(\text{rms})$	–	100	200	$\mu\text{V}$
<b>Signal processing</b>						
Channel separation at $G_V = -20\text{ to }21.5\text{ dB}$	$f = 250\text{ Hz to }10\text{ kHz}$	$\alpha_{\text{CS}}$	46	60	–	dB
Tracking between channels  for $G_V = 21.5\text{ to }-26\text{ dB}$	$f = 250\text{ Hz to }6.3\text{ kHz}$ ; balance at $G_V = 10\text{ dB}$	$\Delta G_V$	–	–	2.5	dB
Ripple rejection	$V_{P(\text{rms})} = \leq 200\text{ mV}$ ; $f = 100\text{ Hz}$ ; $G_V = 0\text{ dB}$	RR	35	50	–	dB
Operating ambient temperature range		$T_{\text{amb}}$	–30	–	+85	$^{\circ}\text{C}$

For explanation of notes see **Notes to the characteristics**.

**PACKAGE OUTLINE:** 18-lead DIL; plastic (SOT102); SOT102-1; 1996 August 06.

Stereo-tone/volume control circuit

TDA1526

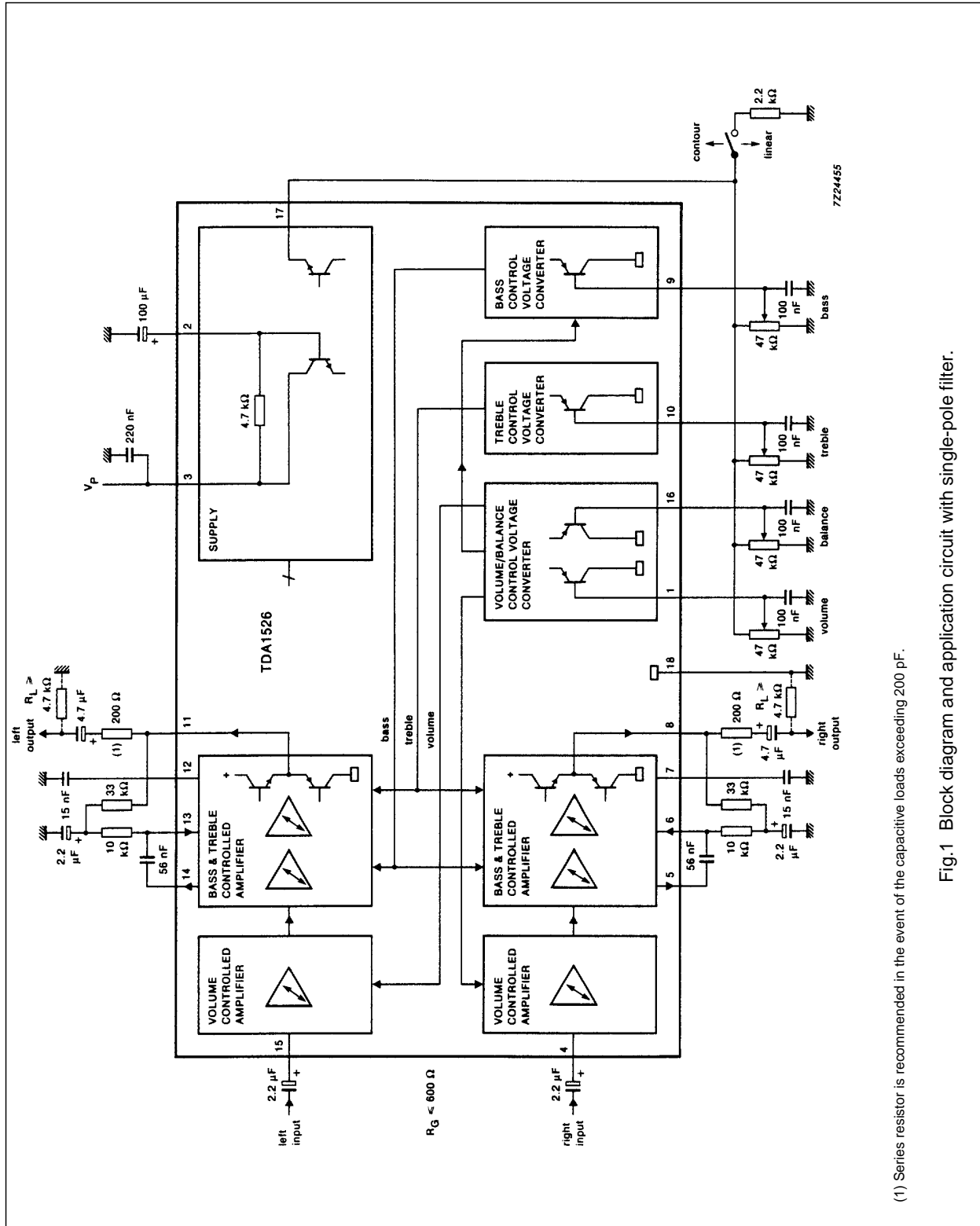
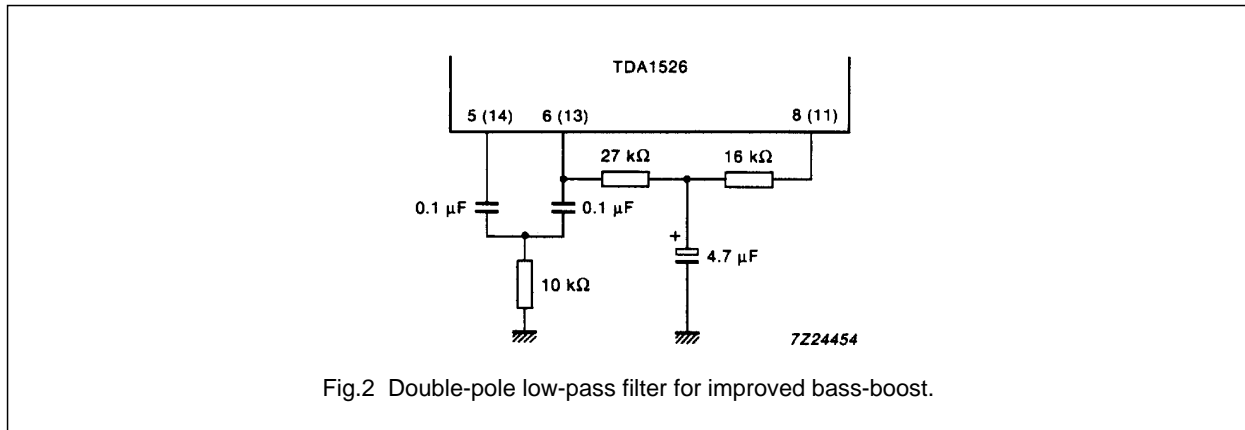

Fig.1 Block diagram and application circuit with single-pole filter.

## Stereo-tone/volume control circuit

## TDA1526

**RATINGS**

Limiting values in accordance with the Absolute Maximum System (IEC 134)

PARAMETER	SYMBOL	MIN.	MAX.	UNIT
Supply voltage (pin 3)	$V_P$	–	20	V
Total power dissipation	$P_{tot}$	–	1200	mW
Storage temperature range	$T_{stg}$	–55	+ 150	°C
Operating ambient temperature range	$T_{amb}$	–30	+ 80	°C

## Stereo-tone/volume control circuit

## TDA1526

**DC CHARACTERISTICS**

$V_P = V_{3-18} = 12\text{ V}$ ;  $T_{\text{amb}} = 25\text{ °C}$ ; measured in Fig.1;  $R_G \leq 600\ \Omega$ ;  $R_L \geq 4.7\text{ k}\Omega$ ;  $C_L \leq 200\text{ pF}$ ; unless otherwise specified

PARAMETER	SYMBOL	MIN.	TYP.	MAX.	UNIT
<b>Supply (pin 3)</b>					
Supply voltage	$V_P = V_{3-18}$	7.5	–	16.5	V
Supply current					
at $V_P = 8.5\text{ V}$	$I_P = I_3$	19	27	35	mA
at $V_P = 12\text{ V}$	$I_P = I_3$	25	35	45	mA
at $V_P = 15\text{ V}$	$I_P = I_3$	30	43	56	mA
<b>DC input levels (pins 4 and 15)</b>					
at $V_P = 8.5\text{ V}$	$V_{4, 15-18}$	3.8	4.25	4.7	V
at $V_P = 12\text{ V}$	$V_{4, 15-18}$	5.3	5.9	6.6	V
at $V_P = 15\text{ V}$	$V_{4, 15-18}$	6.5	7.3	8.2	V
<b>DC output levels (pins 8 and 11)</b>					
under all control voltage conditions with DC feedback					
at $V_P = 8.5\text{ V}$	$V_{8, 11-18}$	3.3	4.25	5.2	V
at $V_P = 12\text{ V}$	$V_{8, 11-18}$	4.6	6.0	7.4	V
at $V_P = 15\text{ V}$	$V_{8, 11-18}$	5.7	7.5	9.3	V
<b>Pin 17</b>					
Internal potentiometer supply voltage					
at $V_P = 8.5\text{ V}$	$V_{17-18}$	3.5	3.75	4.0	V
Contour on/off switch (control by $I_{17}$ )					
contour (switch open)	$-I_{17}$	–	–	0.5	mA
linear (switch closed)	$-I_{17}$	1.5	–	10	mA
Application without internal potentiometer supply voltage at $V_P \geq 10.8\text{ V}$ (contour cannot be switched off)					
Voltage range forced to pin 17	$V_{17-18}$	4.5	–	$V_P/2 - V_{BE}$	V
DC control voltage range for volume, bass, treble and balance (pins 1, 9, 10 and 16 respectively)					
at $V_{17-18} = 5\text{ V}$	$V_{1,9,10,16}$	1.0	–	4.25	V
using internal supply	$V_{1,9,10,16}$	0.25	–	3.8	V
Input current of control inputs (pins 1, 9, 10 and 16)					
	$-I_{1,9,10,16}$	–	–	5	$\mu\text{A}$

## Stereo-tone/volume control circuit

## TDA1526

**AC CHARACTERISTICS**

$V_P = V_{3-18} = 8.5 \text{ V}$ ;  $T_{\text{amb}} = 25 \text{ }^\circ\text{C}$ ; measured in Fig.1; contour switch closed (linear position); volume, balance, bass, and treble controls in mid-position;  $R_G \leq 600 \text{ } \Omega$ ;  $R_L \geq 4.7 \text{ k}\Omega$ ;  $C_L \leq 200 \text{ pF}$ ;  $f = 1 \text{ kHz}$ ; unless otherwise specified

PARAMETER	SYMBOL	MIN.	TYP.	MAX.	UNIT
<b>Control range</b>					
Maximum gain of volume (Fig.4)	$G_{V \text{ max}}$	20.5	21.5	23	dB
Volume control range; $G_{V \text{ max}}/G_{V \text{ min}}$	$\Delta G_V$	90	100	–	dB
Balance control range; $G_V = 0 \text{ dB}$ (Fig.5)	$\Delta G_V$	–	–40	–	dB
Bass control range at 40 Hz (Fig.6)	$\Delta G_V$	–	–19 to +17 $\pm$ 3	–	dB
Treble control range at 16 kHz (Fig.7)	$\Delta G_V$	–	$\pm 15 \pm 3$	–	dB
Contour characteristics			see Figs 9 and 10		
<b>Signal inputs, outputs</b>					
Input resistance; pins 4 and 15 (note 1)					
at gain of volume control: $G_V = 20 \text{ dB}$	$R_{i4, 15}$	10	–	–	k $\Omega$
$G_V = -40 \text{ dB}$	$R_{i4, 15}$	–	160	–	k $\Omega$
Output resistance (pins 8 and 11)	$R_{o8, 11}$	–	–	300	$\Omega$
<b>Signal processing</b>					
Power supply ripple rejection					
at $V_{P(\text{rms})} \leq 200 \text{ mV}$ ; $f = 100 \text{ Hz}$ ; $G_V = 0 \text{ dB}$	RR	35	50	–	dB
Channel separation (250 Hz to 10 kHz)					
at $G_V = -20 \text{ to } +21.5 \text{ dB}$	$\alpha_{\text{cs}}$	46	60	–	dB
Spread of volume control with					
constant control voltage $V_{1-18} = 0.5 V_{17-18}$	$\Delta G_V$	–	–	$\pm 3$	dB
Gain tolerance between left and right					
channel $V_{16-18} = V_{1-18} = 0.5 V_{17-18}$	$\Delta G_{V, L-R}$	–	–	1.5	dB
Tracking between channels					
for $G_V = 21.5 \text{ to } -26 \text{ dB}$					
$f = 250 \text{ Hz to } 6.3 \text{ kHz}$ ; balance adjusted at					
$G_V = 10 \text{ dB}$	$\Delta G_V$	–	–	2.5	dB
<b>Signal handling with DC feedback</b>					
Input signal handling					
at $V_P = 8.5 \text{ V} - 15 \text{ V}$ ; THD = 0.7%;					
$f = 1 \text{ kHz}$ (RMS value)	$V_{i(\text{rms})}$	1.8	2.0	–	V
Output signal handling (note 2 and note 3)					
at $V_P = 8.5 \text{ V}$ ; THD = 0.7%;					
$f = 1 \text{ kHz}$ (RMS value)	$V_{o(\text{rms})}$	1.8	2.0	–	V
<b>Noise performance</b> ( $V_P = 12 \text{ V}$ )					
Output noise voltage (unweighted; Fig.14)					
at $f = 20 \text{ Hz to } 20 \text{ kHz}$ (RMS value; note 4)					
for $G_V = -16 \text{ dB}$ (note 5)	$V_{\text{no}(\text{rms})}$	–	100	200	$\mu\text{V}$

## Stereo-tone/volume control circuit

TDA1526

**Notes to the characteristics**

- Equation for input resistance (see also Fig.3)

$$R_i = \frac{160 \text{ k}\Omega}{1 + G_v}; G_{v \text{ max}} = 12.$$

- Frequencies below 200 Hz and above 5 kHz have reduced voltage swing, the reduction at 40 Hz and 16 kHz is 30%.
- In the event of bass boosting the output signal handling is reduced. The reduction is 1 dB for maximum bass boost.
- For peak values add 4.5 dB to RMS values.
- Linear frequency response.

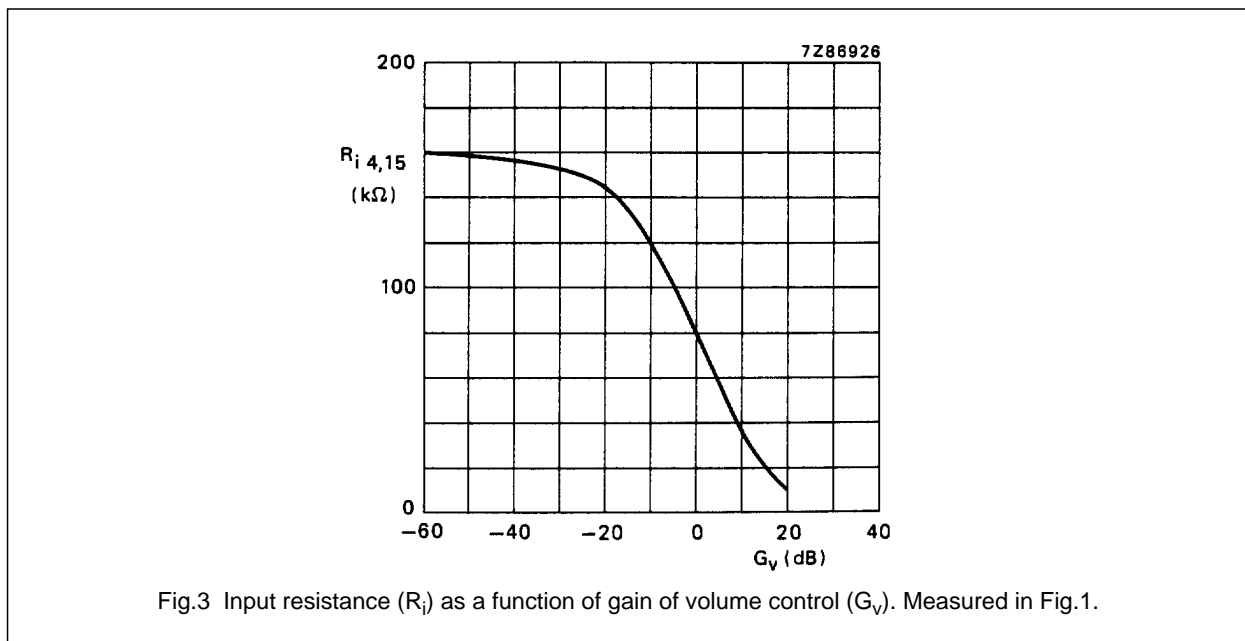

Stereo-tone/volume control circuit

TDA1526

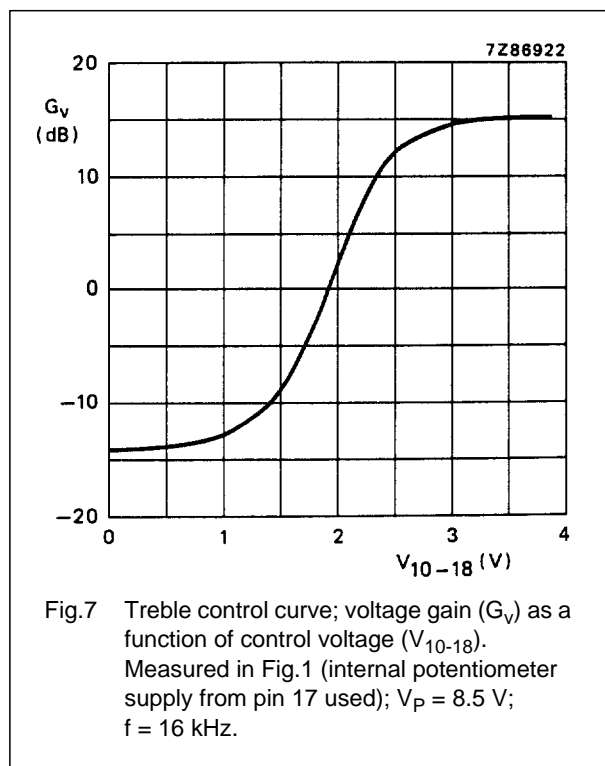
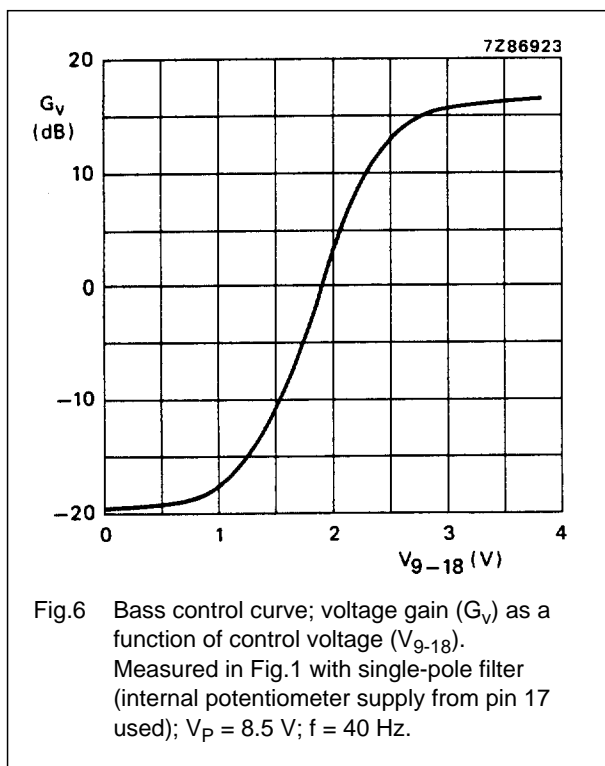
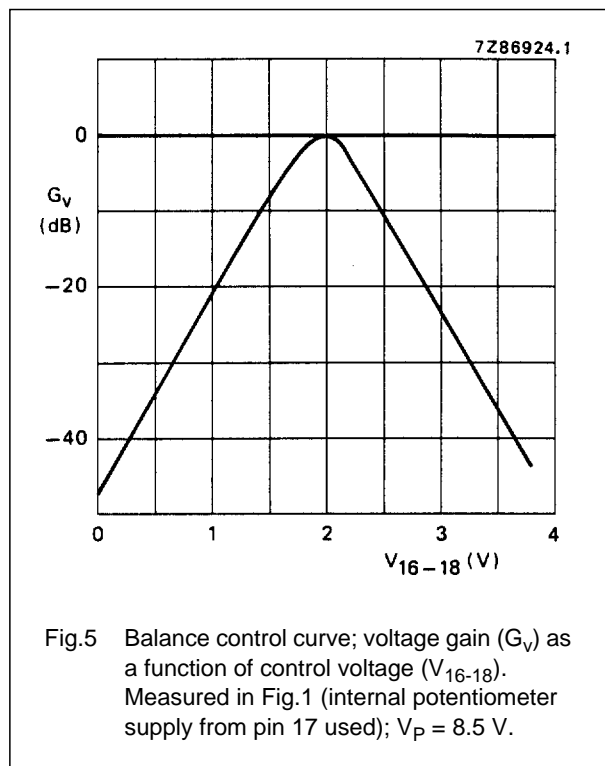
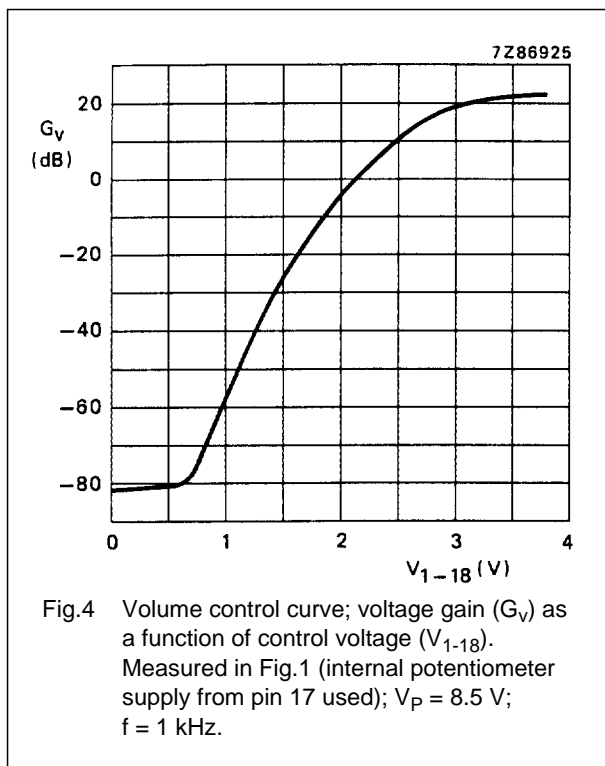



## Stereo-tone/volume control circuit

TDA1526

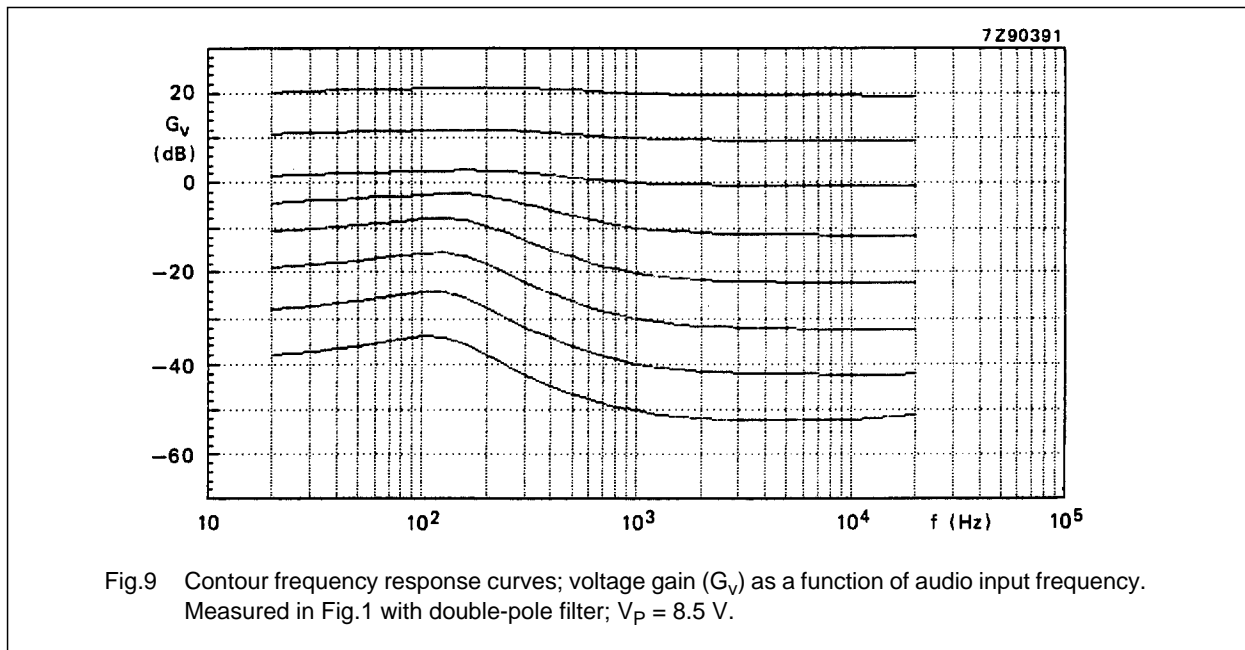
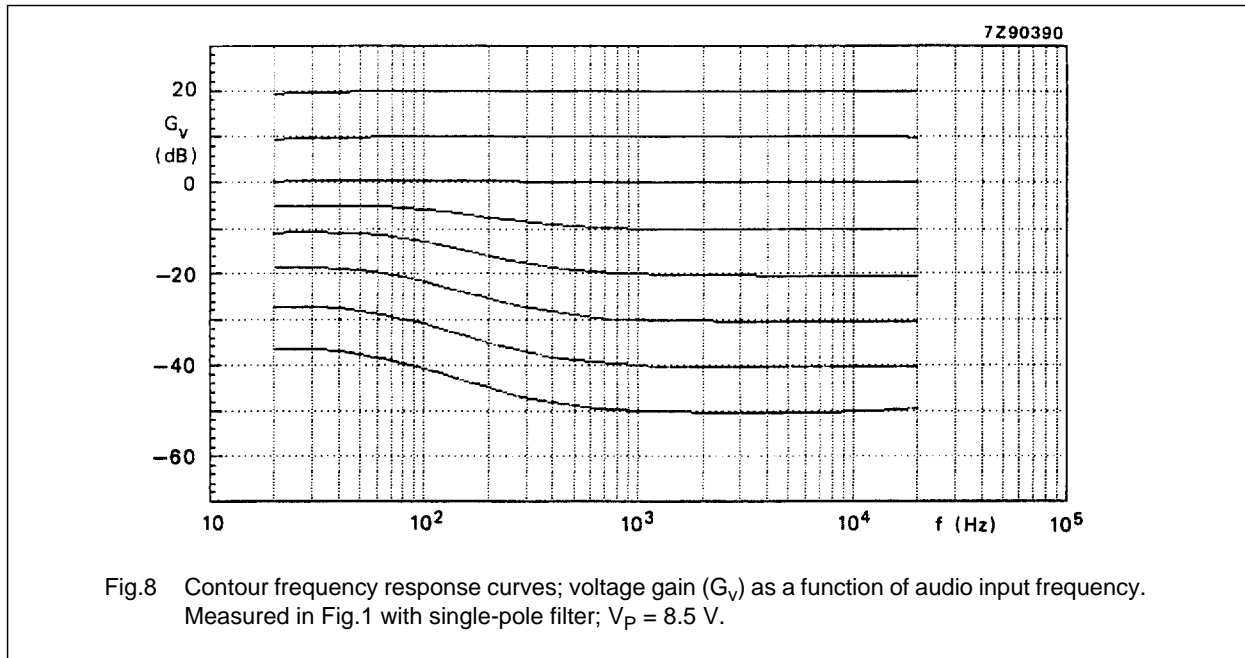

## Stereo-tone/volume control circuit

TDA1526

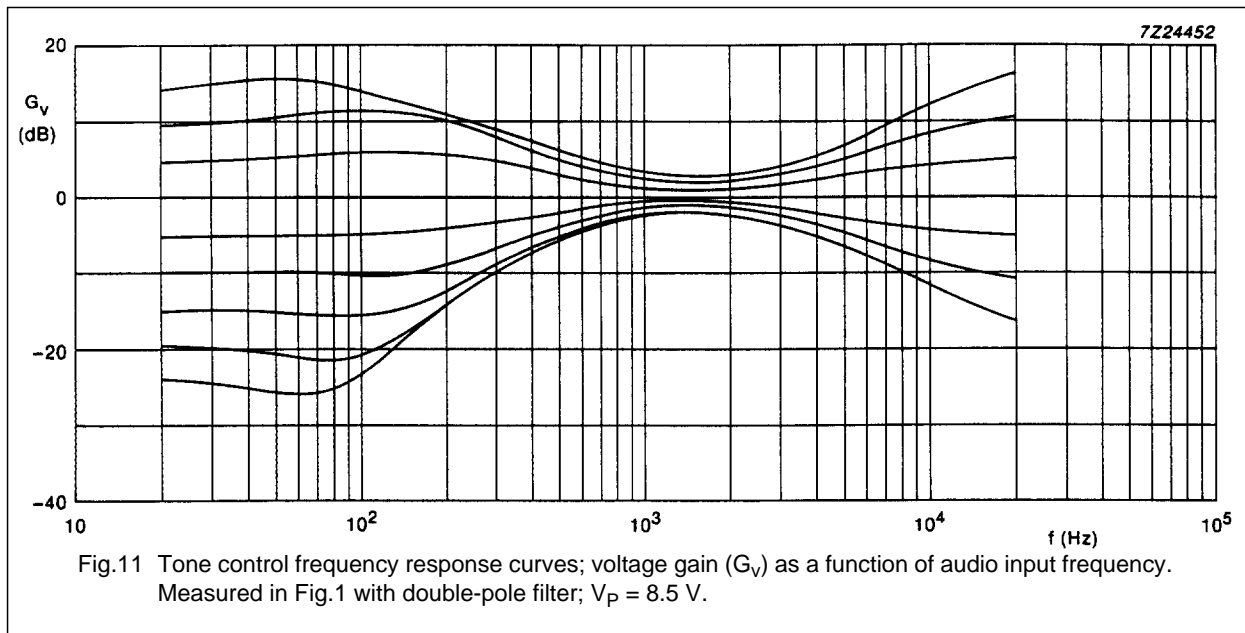
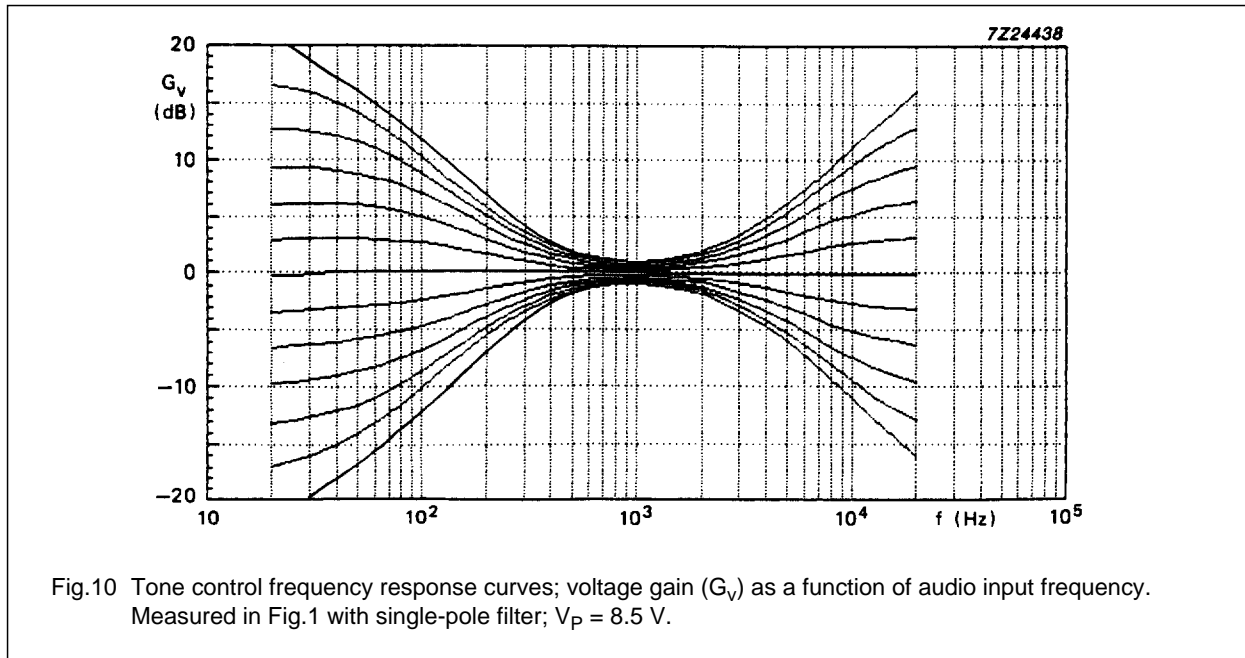

Stereo-tone/volume control circuit

TDA1526

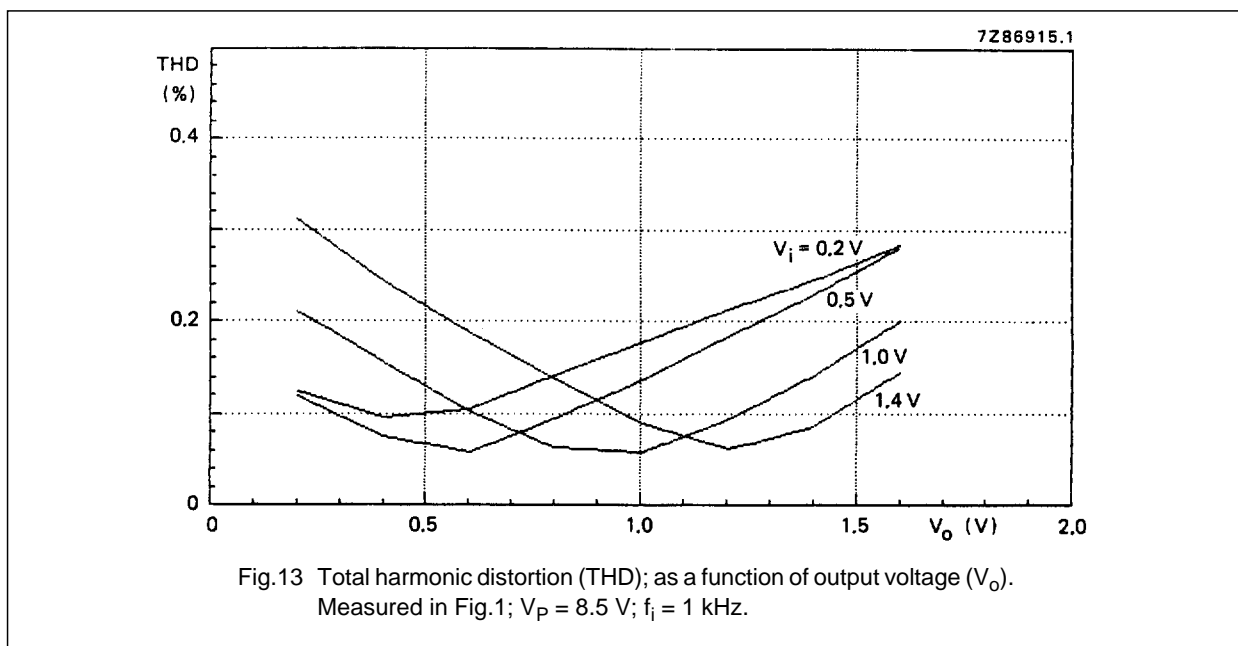
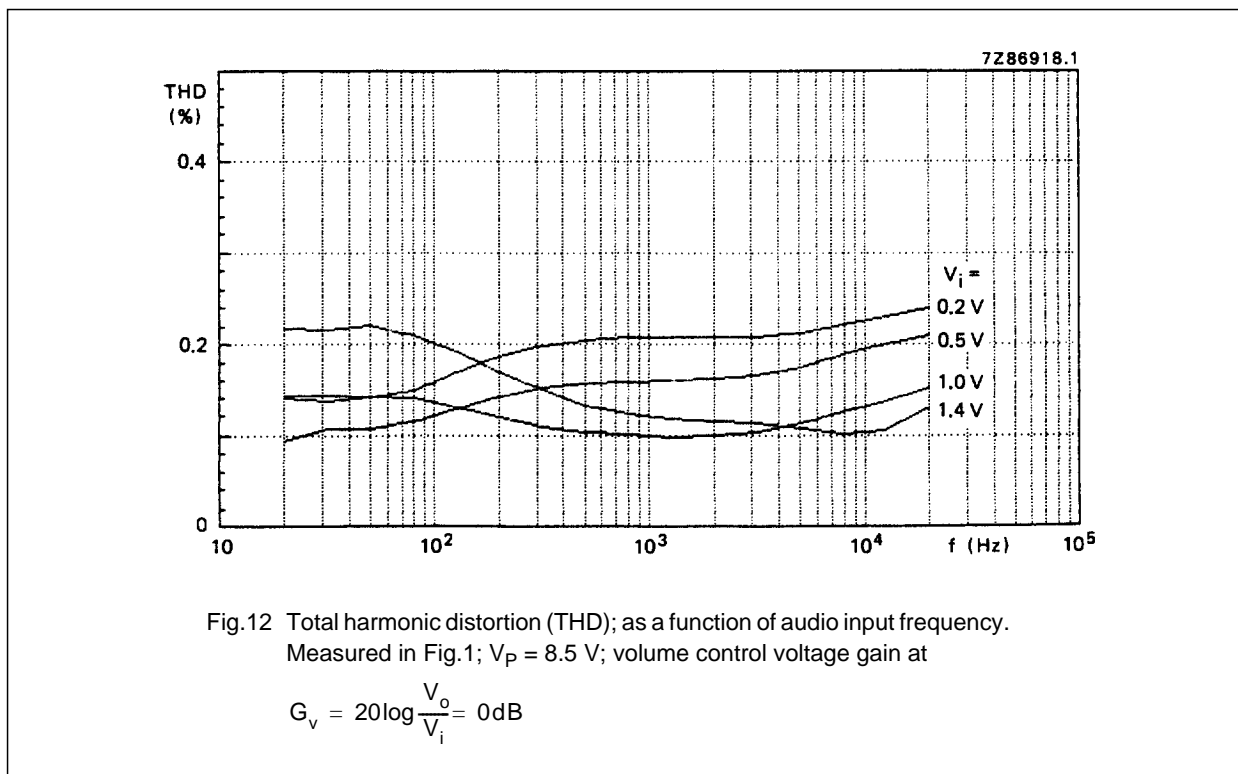

Stereo-tone/volume control circuit

TDA1526

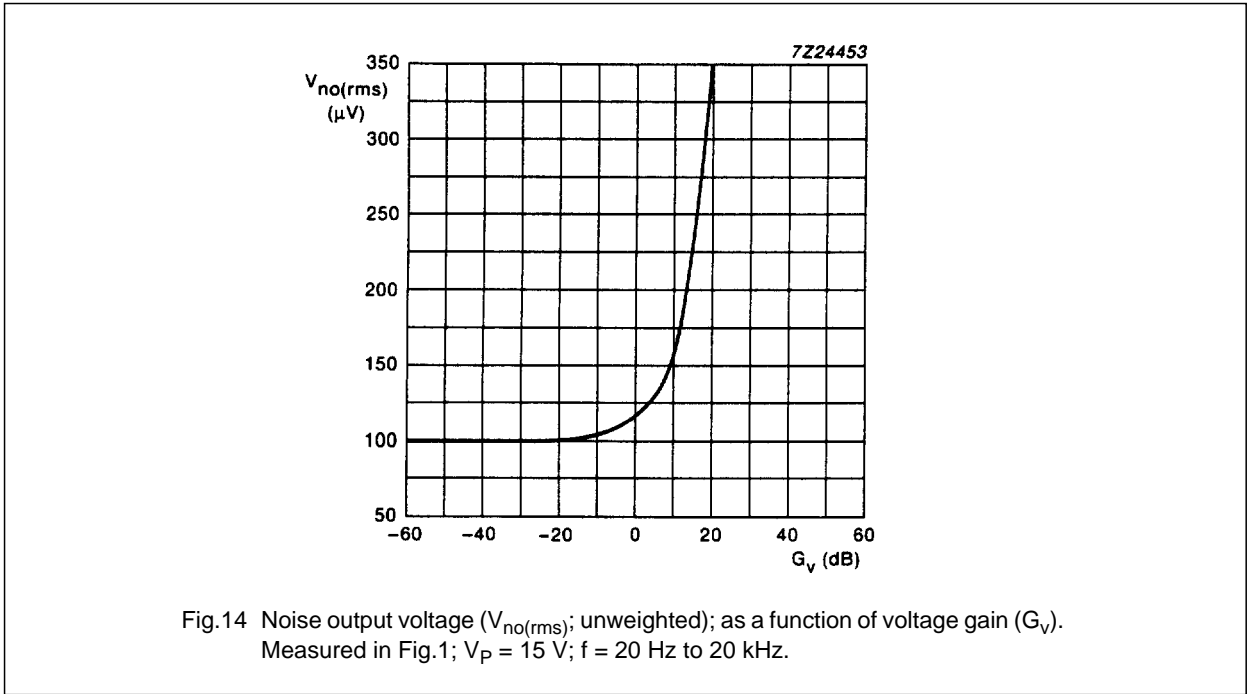

Stereo-tone/volume control circuit

TDA1526

PACKAGE OUTLINE

DIP18: plastic dual in-line package; 18 leads (300 mil)

SOT102-1

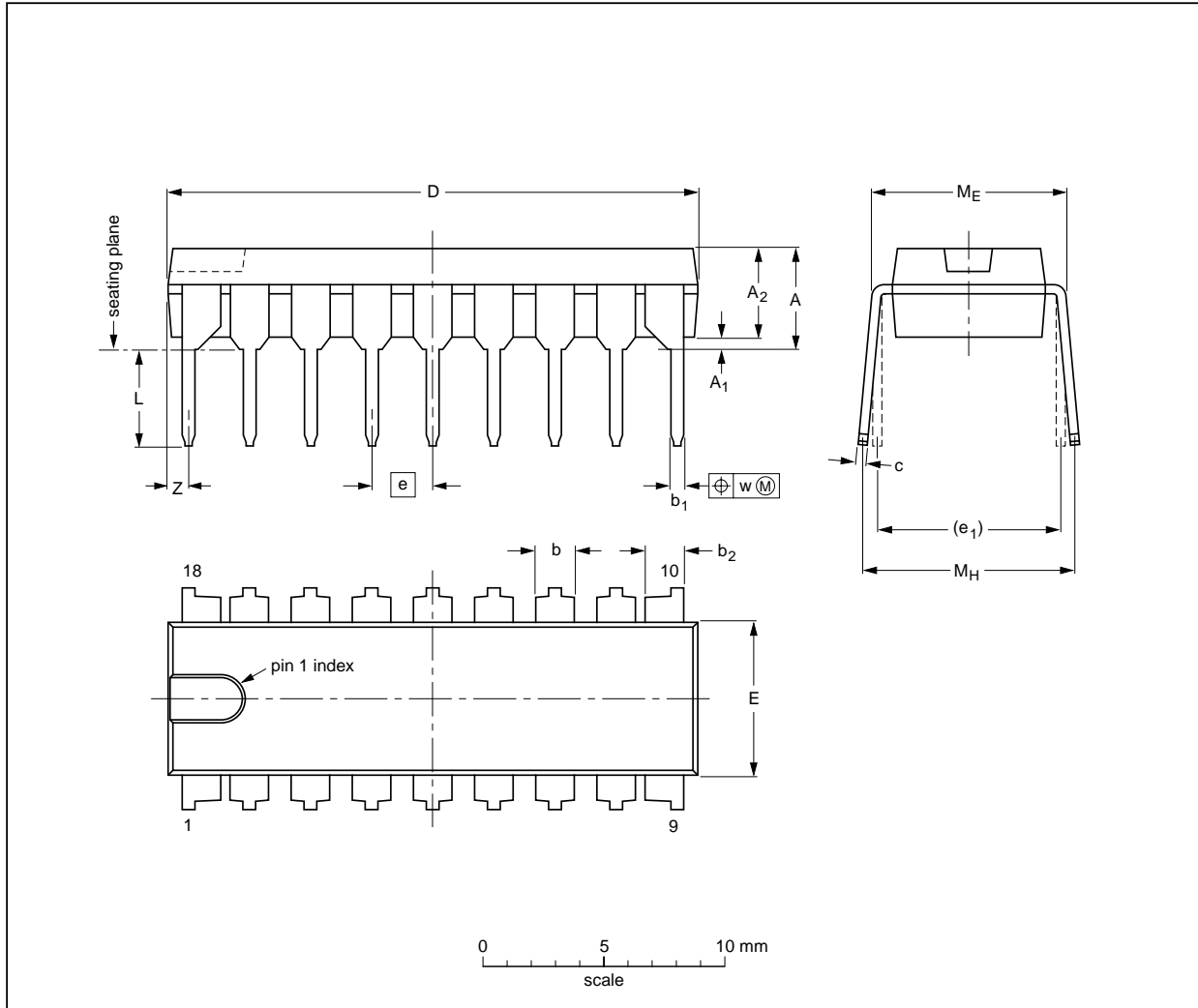

DIMENSIONS (inch dimensions are derived from the original mm dimensions)

UNIT	A max.	A <sub>1</sub> min.	A <sub>2</sub> max.	b	b <sub>1</sub>	b <sub>2</sub>	c	D <sup>(1)</sup>	E <sup>(1)</sup>	e	e <sub>1</sub>	L	M <sub>E</sub>	M <sub>H</sub>	w	Z <sup>(1)</sup> max.
mm	4.7	0.51	3.7	1.40 1.14	0.53 0.38	1.40 1.14	0.32 0.23	21.8 21.4	6.48 6.20	2.54	7.62	3.9 3.4	8.25 7.80	9.5 8.3	0.254	0.85
inches	0.19	0.020	0.15	0.055 0.044	0.021 0.015	0.055 0.044	0.013 0.009	0.86 0.84	0.26 0.24	0.10	0.30	0.15 0.13	0.32 0.31	0.37 0.33	0.01	0.033

Note

1. Plastic or metal protrusions of 0.25 mm maximum per side are not included.

OUTLINE VERSION	REFERENCES				EUROPEAN PROJECTION	ISSUE DATE
	IEC	JEDEC	EIAJ			
SOT102-1						93-10-14 95-01-23

## Stereo-tone/volume control circuit

TDA1526

**SOLDERING****Introduction**

There is no soldering method that is ideal for all IC packages. Wave soldering is often preferred when through-hole and surface mounted components are mixed on one printed-circuit board. However, wave soldering is not always suitable for surface mounted ICs, or for printed-circuits with high population densities. In these situations reflow soldering is often used.

This text gives a very brief insight to a complex technology. A more in-depth account of soldering ICs can be found in our "IC Package Databook" (order code 9398 652 90011).

**Soldering by dipping or by wave**

The maximum permissible temperature of the solder is 260 °C; solder at this temperature must not be in contact with the joint for more than 5 seconds. The total contact time of successive solder waves must not exceed 5 seconds.

The device may be mounted up to the seating plane, but the temperature of the plastic body must not exceed the specified maximum storage temperature ( $T_{stg\ max}$ ). If the printed-circuit board has been pre-heated, forced cooling may be necessary immediately after soldering to keep the temperature within the permissible limit.

**Repairing soldered joints**

Apply a low voltage soldering iron (less than 24 V) to the lead(s) of the package, below the seating plane or not more than 2 mm above it. If the temperature of the soldering iron bit is less than 300 °C it may remain in contact for up to 10 seconds. If the bit temperature is between 300 and 400 °C, contact may be up to 5 seconds.

**DEFINITIONS**

<b>Data sheet status</b>	
Objective specification	This data sheet contains target or goal specifications for product development.
Preliminary specification	This data sheet contains preliminary data; supplementary data may be published later.
Product specification	This data sheet contains final product specifications.
<b>Limiting values</b>	
Limiting values given are in accordance with the Absolute Maximum Rating System (IEC 134). Stress above one or more of the limiting values may cause permanent damage to the device. These are stress ratings only and operation of the device at these or at any other conditions above those given in the Characteristics sections of the specification is not implied. Exposure to limiting values for extended periods may affect device reliability.	
<b>Application information</b>	
Where application information is given, it is advisory and does not form part of the specification.	

**LIFE SUPPORT APPLICATIONS**

These products are not designed for use in life support appliances, devices, or systems where malfunction of these products can reasonably be expected to result in personal injury. Philips customers using or selling these products for use in such applications do so at their own risk and agree to fully indemnify Philips for any damages resulting from such improper use or sale.