

TDA1190 • TDA1190Z

ONE CHIP TV SOUND SYSTEM

FAIRCHILD LINEAR INTEGRATED CIRCUITS

GENERAL DESCRIPTION — The TDA1190 and TDA1190Z are silicon monolithic integrated circuits in 12-pin plastic power packages. They perform all the functions needed for TV sound systems, including IF limiter-amplifier, FM detector, AF preamplifier and power output stage. The TDA1190 is specified for 5.5 MHz (PAL) sound systems and the TDA1190Z is specified for 4.5 MHz (NTSC) sound systems. They are constructed using the Fairchild Planar* epitaxial process.

They provide an output power of 4.2 W into a 16 Ω load at V+ = 24 V, or 1.5 W into an 8.0 Ω load at V+ = 12 V. This performance, together with the FM-IF section characteristics of high sensitivity, high AM rejection and low distortion, enables them to be used in almost every type of television receiver. No external shielding is needed.

The basic differences between the TDA1190 and TDA1190Z are:

The TDA1190Z is designed for a larger volume control potentiometer (22 kΩ vs 2.2 kΩ). The TDA1190 includes one of the gain adjust resistors on the chip, while in the TDA1190Z both are required in the external circuitry.

- DC VOLUME CONTROL
- ACTIVE LOW PASS FILTER
- OUTPUT POWER 4.2 W (24 V — 16 Ω)
- HIGH SENSITIVITY
- EXCELLENT AM REJECTION

ABSOLUTE MAXIMUM RATINGS

Supply Voltage	28 V
Input Signal Voltage	1.0 V
Output Peak Current (Non-repetitive)	2.0 A
Output Peak Current (Repetitive)	1.5 A
Power Dissipation: at T _{tab} = 90°C	5.0 W
at T _A = 80°C (Free Air)	1.0 W
Storage and Junction Temperature	-40°C to +150°C
Pin Temperature (Soldering, 10 s)	260°C

03/885

MOT RPA

CONNECTION DIAGRAM
12-PIN POWER PACKAGE
(TOP VIEW)
PACKAGE OUTLINE 9W
PACKAGE CODE P3

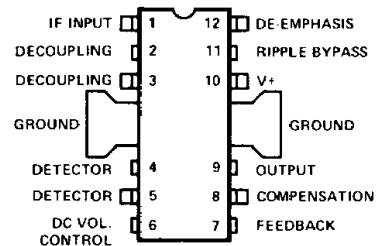

ORDER INFORMATION

TYPE	PART NO.
1190	TDA1190
1190Z	TDA1190Z

*Planar is a patented Fairchild process.

EQUIVALENT CIRCUIT

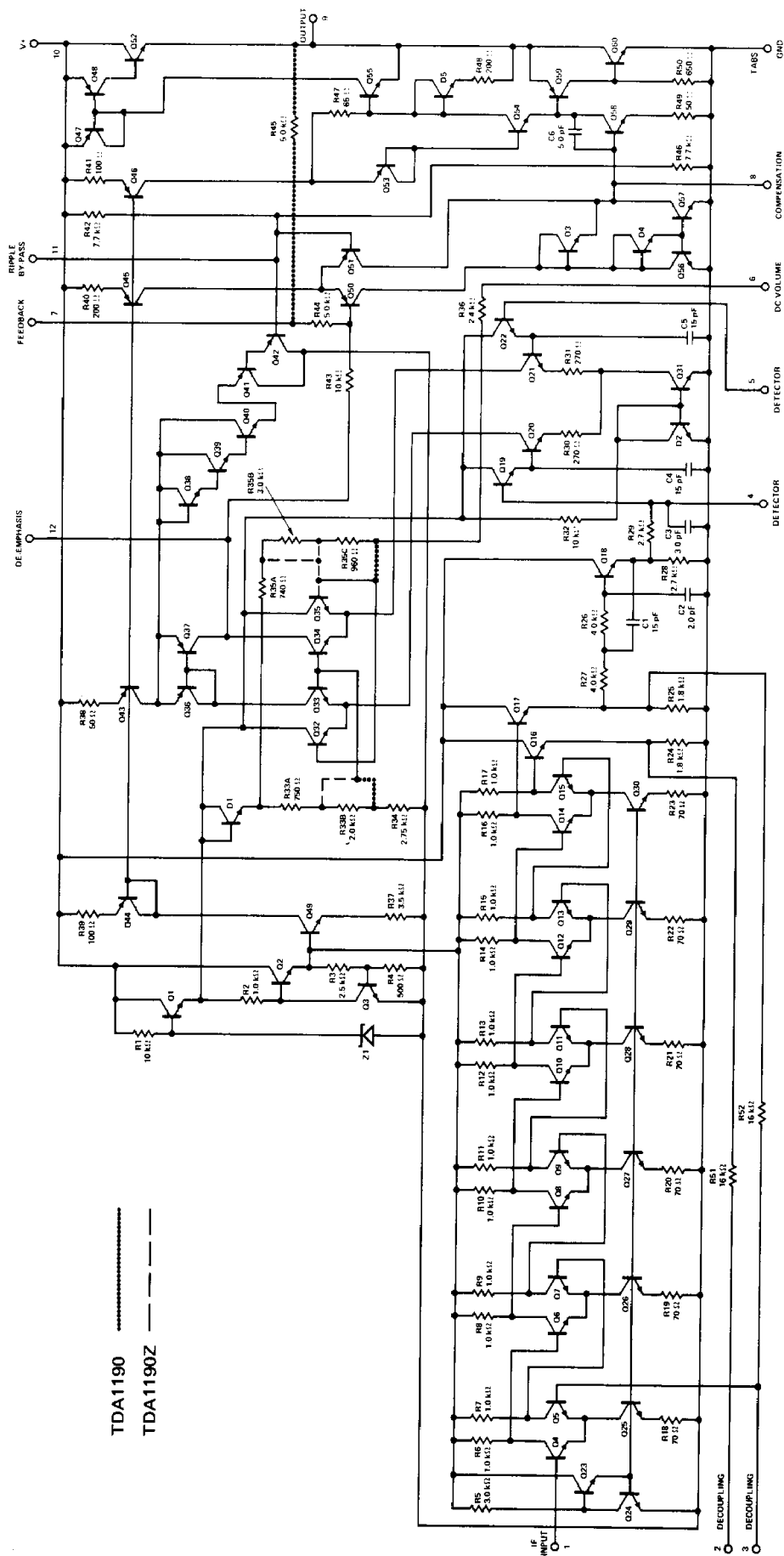

FAIRCHILD • TDA1190/TDA1190Z

BLOCK DIAGRAM

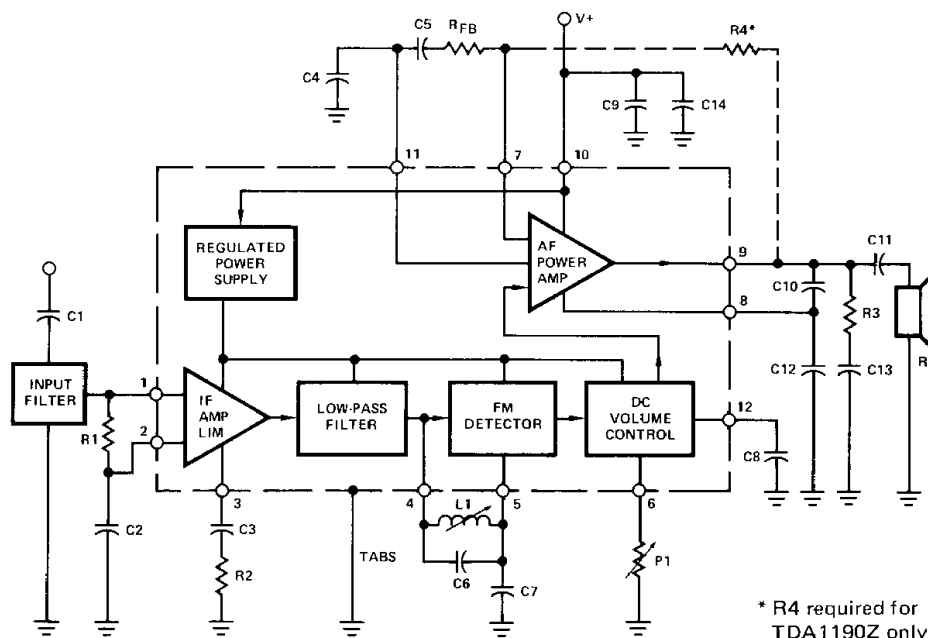

TDA1190

ELECTRICAL CHARACTERISTICS: See Test Circuits

$V_+ = 24\text{ V}$, $T_A = 25^\circ\text{C}$ unless otherwise specified.

CHARACTERISTICS	TEST CONDITIONS	MIN	TYP	MAX	UNITS
Supply Voltage (Pin 10)		9.0		28	V
Quiescent Output Voltage (Pin 9)	$V_+ = 24\text{ V}$	11	12	13	V
	$V_+ = 12\text{ V}$	5.5	6.0	6.5	V
Quiescent Drain Current	$P1 = 2.2\text{ k}\Omega$	$V_+ = 24\text{ V}$	22	35	mA
		$V_+ = 12\text{ V}$	19	31	mA
Output Power	THD = 10%, $f_o = 5.5\text{ MHz}$, $f_m = 1.0\text{ kHz}$, $\Delta f = \pm 25\text{ kHz}$	3.0	4.2		W
	$V_+ = 24\text{ V}$, $R_L = 16\ \Omega$ $V_+ = 12\text{ V}$, $R_L = 8.0\ \Omega$		1.5		W
Output Power	THD = 2%, $f_o = 5.5\text{ MHz}$, $f_m = 1.0\text{ kHz}$, $\Delta f = \pm 25\text{ kHz}$		3.4		W
	$V_+ = 24\text{ V}$, $R_L = 16\ \Omega$ $V_+ = 12\text{ V}$, $R_L = 8.0\ \Omega$		1.4		W
Input Limiting Voltage (−3.0 dB) at Pin 1	$f_o = 5.5\text{ MHz}$, $f_m = 1.0\text{ kHz}$, $\Delta f = \pm 7.5\text{ kHz}$, $P1 = 0$		30		μV
Distortion	$P_o = 50\text{ mW}$, $f_o = 5.5\text{ MHz}$, $f_m = 1.0\text{ kHz}$, $\Delta f = \pm 7.5\text{ kHz}$		0.55		%
	$V_+ = 24\text{ V}$, $R_L = 16\ \Omega$ $V_+ = 12\text{ V}$, $R_L = 8.0\ \Omega$		0.65		%
Frequency Response of Audio Amplifier (−3.0 dB)	$R_L = 16\ \Omega$, $C10 = 200\text{ pF}$, $C12 = 1000\text{ pF}$, $P1 = 2.2\text{ k}\Omega$		50 to 12,000		Hz
	$R_{FB} = 18\ \Omega$ $R_{FB} = 10\ \Omega$		50 to 9,100		Hz
Recovered Audio Voltage (Pin 12)	$V_{IN} \geq 1.0\text{ mV}$, $f_o = 5.5\text{ MHz}$, $f_m = 1.0\text{ kHz}$, $\Delta f = \pm 7.5\text{ kHz}$, $P1 = 0$		60		mV
Amplitude Modulation Rejection	$V_{IN} \geq 1.0\text{ mV}$, $f_o = 5.5\text{ MHz}$, $f_m = 1.0\text{ kHz}$, $\Delta f = \pm 50\text{ kHz}$, $m = 0.3$		55		dB
Signal and Noise to Noise Ratio	$V_{IN} \geq 1.0\text{ mV}$, $V_o = 4.0\text{ V}$, $f_o = 5.5\text{ MHz}$, $f_m = 1.0\text{ kHz}$, $\Delta f = \pm 50\text{ kHz}$		70		dB
Feedback Resistance (Between Pins 7 and 9)	Internal Resistor	3.5	5.0	6.5	k Ω
Input Resistance (Pin 1)			30		k Ω
Input Capacitance (Pin 1)	$V_{IN} = 1.0\text{ mV}$, $f_o = 5.5\text{ MHz}$		5.0		pF
Supply Voltage Rejection Ratio	$R_L = 4.0\ \Omega$, $f_{\text{ripple}} = 100\text{ Hz}$, $P1 = 2.2\text{ k}\Omega$		46		dB
DC Volume Control Attenuation	$P1 = 2.2\text{ k}\Omega$		90		dB

TDA1190Z

ELECTRICAL CHARACTERISTICS: See Test Circuits

V+ = 24 V, T_A = 25°C unless otherwise specified.

CHARACTERISTICS	TEST CONDITIONS	MIN	TYP	MAX	UNITS
Supply Voltage (Pin 10)		9.0		28	V
Quiescent Output Voltage (Pin 9)	V+ = 24 V	11	12	13	V
	V+ = 12 V	5.1	6.0	6.9	V
Quiescent Drain Current	P1 = 22 kΩ	11	22	35	mA
	V+ = 24 V V+ = 12 V		19		mA
Output Power	THD = 10%, f _o = 4.5 MHz, f _m = 400 Hz, Δf = ±25 kHz		4.2		W
	V+ = 24 V, R _L = 16 Ω V+ = 12 V, R _L = 8.0 Ω		1.5		W
Output Power	THD = 2%, f _o = 4.5 MHz, f _m = 400 Hz, Δf = ±25 kHz		3.5		W
	V+ = 24 V, R _L = 16 Ω V+ = 12 V, R _L = 8.0 Ω		1.4		W
Input Limiting Voltage (−3.0 dB) at Pin 1	f _o = 4.5 MHz, f _m = 400 Hz, Δf = ±7.5 kHz, P1 = 0		40	100	μV
Distortion	P _o = 50 mW, f _o = 4.5 MHz, f _m = 400 Hz, Δf = ±7.5 kHz		0.75		%
	V+ = 24 V, R _L = 16 Ω V+ = 12 V, R _L = 8.0 Ω		1.0		%
Frequency Response of Audio Amplifier (−3.0 dB)	R _L = 16 Ω, C10 = 120 pF, C12 = 470 pF, P1 = 22 kΩ		70 to 12,000		Hz
	R _{FB} = 82 Ω R _{FB} = 47 Ω		70 to 7,000		Hz
Recovered Audio Voltage (Pin 12)	V _{IN} ≥ 1.0 mV, f _o = 4.5 MHz, f _m = 400 Hz, Δf = ±7.5 kHz, P1 = 0		120		mV
Amplitude Modulation Rejection	V _{IN} ≥ 1.0 mV, f _o = 4.5 MHz, f _m = 400 Hz, Δf = ±25 kHz, m = 0.3		55		dB
Signal and Noise to Noise Ratio	V _{IN} ≥ 1.0 mV, V _o = 4.0 V, f _o = 4.5 MHz, f _m = 400 Hz, Δf = ±25 kHz	50	65		dB
Feedback Resistance (Between Pins 7 and 9)	External Resistor		22		kΩ
Input Resistance (Pin 1)			30		kΩ
Input Capacitance (Pin 1)	V _{IN} = 1.0 mV, f _o = 4.5 MHz		5.0		pF
Supply Voltage Rejection Ratio	R _L = 4.0 Ω, f _{ripple} = 100 Hz, P1 = 22 kΩ		46		dB
DC Volume Control Attenuation	P1 = 12 kΩ		90		dB

PACKAGE THERMAL RESISTANCE

θ _{j-tab}	Thermal resistance junction-tab	max	12	°C/W
θ _{j-amb}	Thermal resistance junction-ambient	max	70*	°C/W

*With tabs soldered to printed circuit with minimized copper area.

TEST CIRCUIT – TDA1190

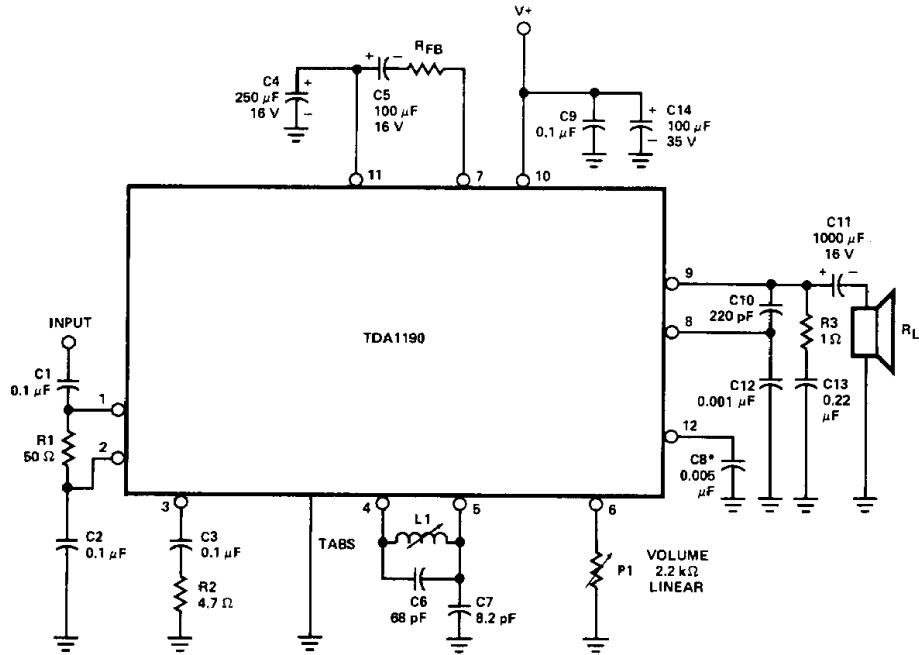

*RC = 50 μs

L1 = 12 μH
 Qu = 80
 f_o = 5.5 MHz

V+	12	24	V
R _L	8	16	Ω
R _{FB}	18	10	Ω

TEST CIRCUIT – TDA1190Z

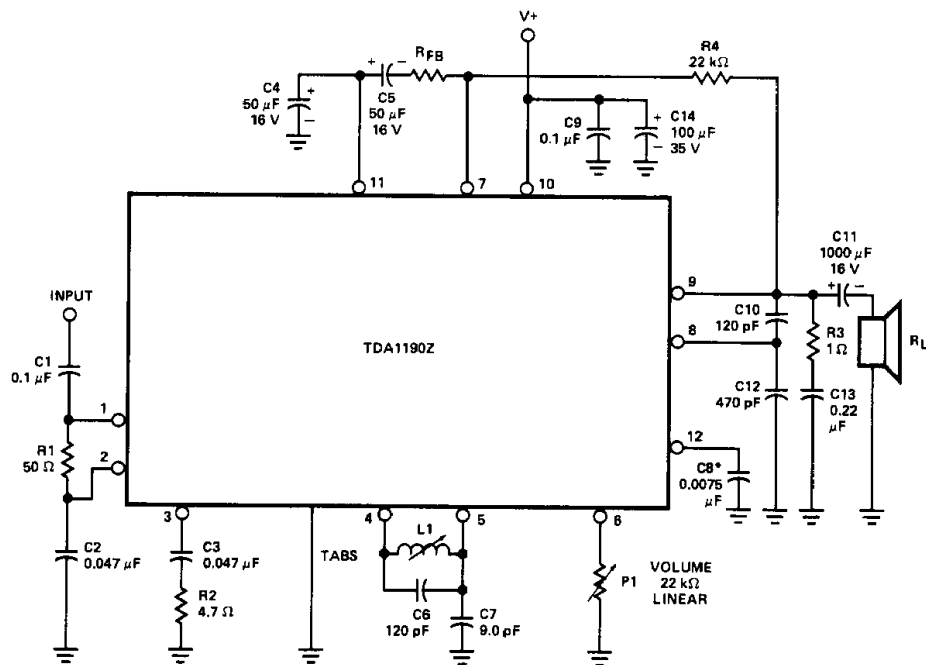

*RC = 75 μs

L1 = 10 μH
 Qu = 60
 f_o ≈ 4.5 MHz

V+	12	24	V
R _L	8	16	Ω
R _{FB}	82	47	Ω

TYPICAL PERFORMANCE CURVES FOR TDA1190

RELATIVE AUDIO OUTPUT VOLTAGE AND OUTPUT NOISE AS A FUNCTION OF INPUT VOLTAGE

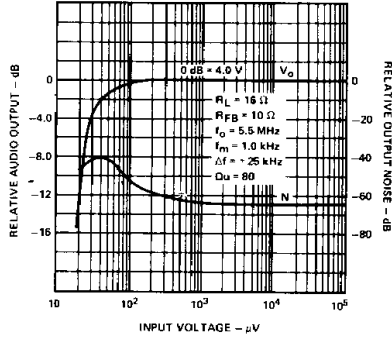

OUTPUT VOLTAGE ATTENUATION AS A FUNCTION OF dc VOLUME CONTROL RESISTANCE

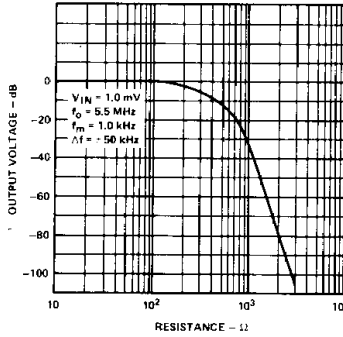

AMPLITUDE MODULATION REJECTION AS A FUNCTION OF INPUT VOLTAGE

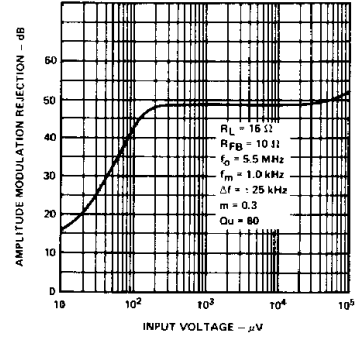

Δ AMR AS A FUNCTION OF CHANGE IN TUNING FREQUENCY

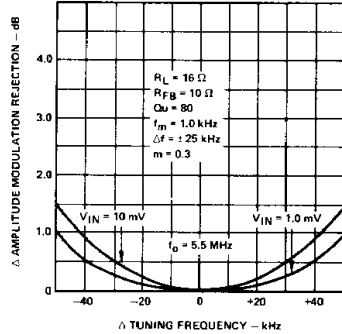

RECOVERED AUDIO AS A FUNCTION OF UNLOADED Q

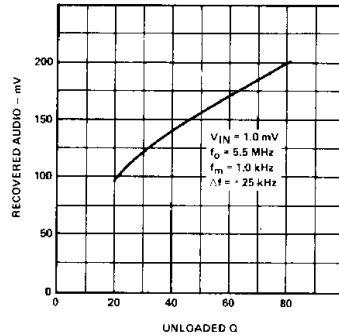

TOTAL HARMONIC DISTORTION AS A FUNCTION OF POWER OUTPUT

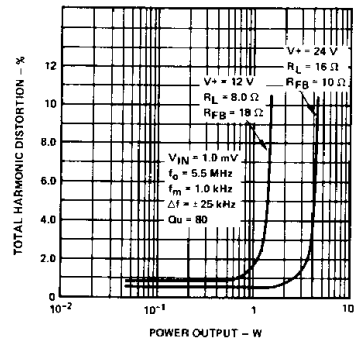

TOTAL HARMONIC DISTORTION AS A FUNCTION OF FREQUENCY DEVIATION

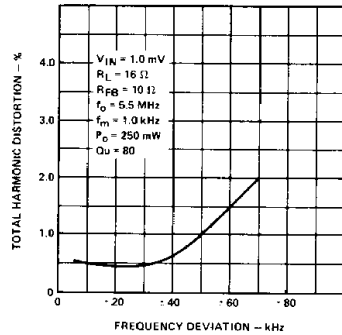

TOTAL HARMONIC DISTORTION AS A FUNCTION OF CHANGE IN TUNING FREQUENCY

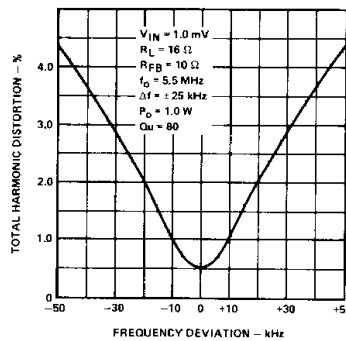

RELATIVE AUDIO AMPLIFIER VOLTAGE GAIN AS A FUNCTION OF FREQUENCY

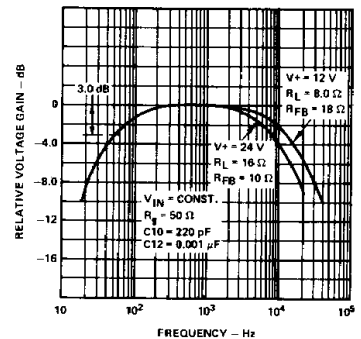

TYPICAL PERFORMANCE CURVES FOR TDA1190 (Cont'd)

RELATIVE OVERALL VOLTAGE GAIN AS A FUNCTION OF FREQUENCY

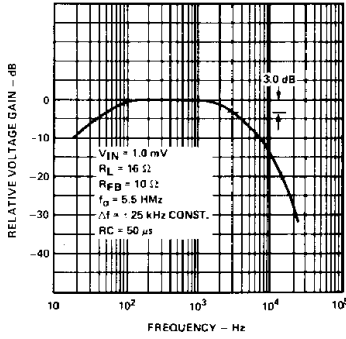

POWER SUPPLY RIPPLE REJECTION AS A FUNCTION OF RIPPLE FREQUENCY

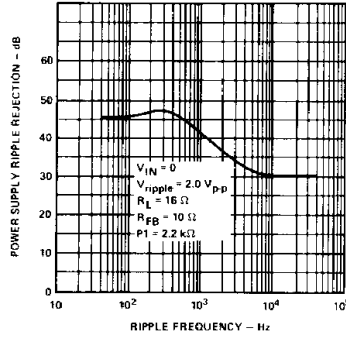

POWER SUPPLY RIPPLE REJECTION AS A FUNCTION OF VOLUME CONTROL ATTENUATION

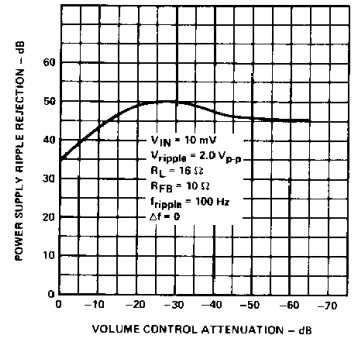

POWER OUTPUT AS A FUNCTION OF SUPPLY VOLTAGE

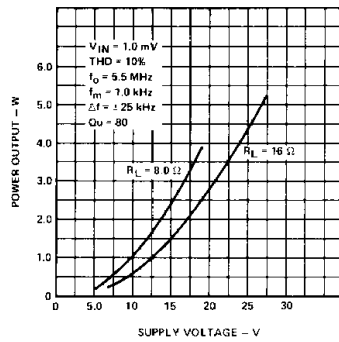

MAXIMUM POWER DISSIPATION AS A FUNCTION OF SUPPLY VOLTAGE (SINE WAVE OPERATION)

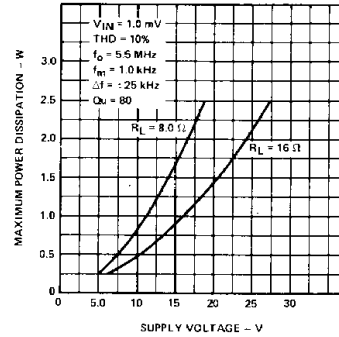

POWER DISSIPATION AND EFFICIENCY AS A FUNCTION OF POWER OUTPUT

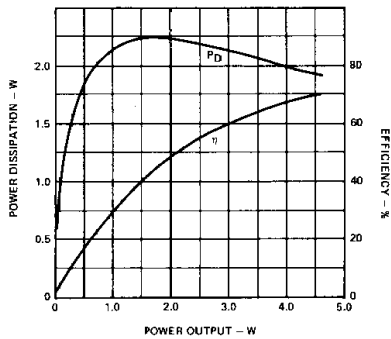

QUIESCENT OUTPUT VOLTAGE (PIN 9) AS A FUNCTION OF SUPPLY VOLTAGE

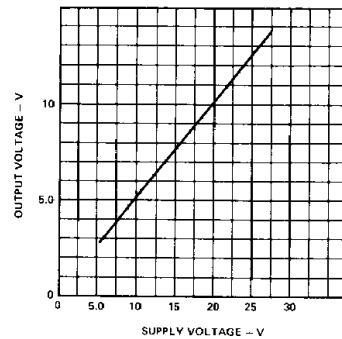

TYPICAL PERFORMANCE CURVES FOR TDA1190Z

RELATIVE AUDIO OUTPUT VOLTAGE AND OUTPUT NOISE AS A FUNCTION OF INPUT VOLTAGE

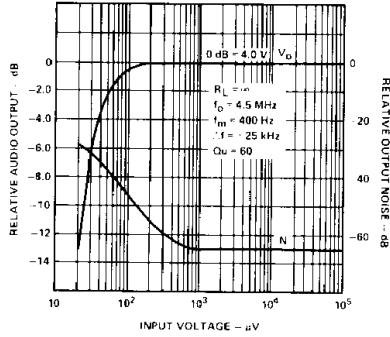

OUTPUT VOLTAGE ATTENUATION AS A FUNCTION OF dc VOLUME CONTROL RESISTANCE

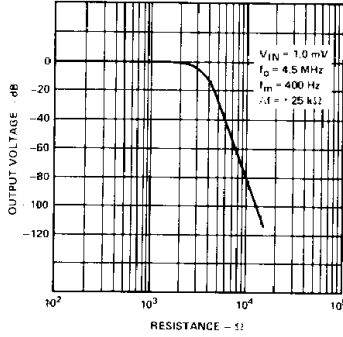

AMR AS A FUNCTION OF INPUT VOLTAGE

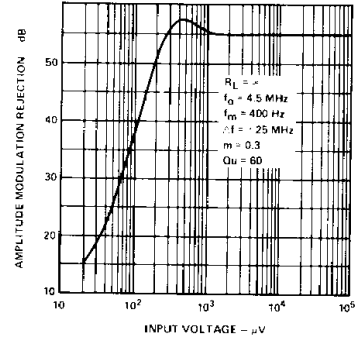

Δ AMR AS A FUNCTION OF CHANGE IN TUNING FREQUENCY

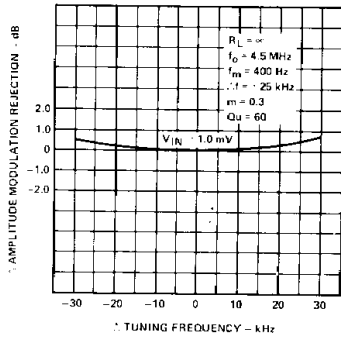

RECOVERED AUDIO AS A FUNCTION OF UNLOADED Q

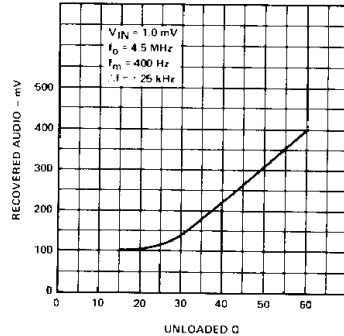

TOTAL HARMONIC DISTORTION AS A FUNCTION OF POWER OUTPUT

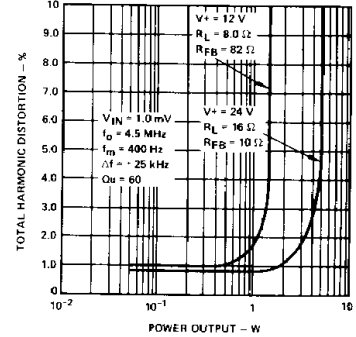

TOTAL HARMONIC DISTORTION AS A FUNCTION OF FREQUENCY DEVIATION

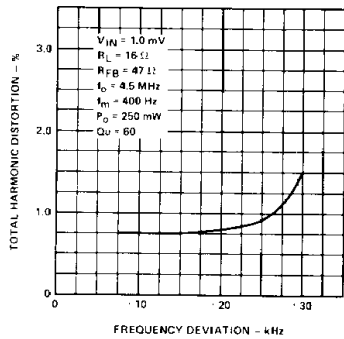

TOTAL HARMONIC DISTORTION AS A FUNCTION OF CHANGE IN TUNING FREQUENCY

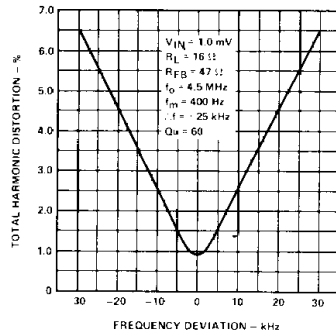

RELATIVE AUDIO AMPLIFIER VOLTAGE GAIN AS A FUNCTION OF FREQUENCY

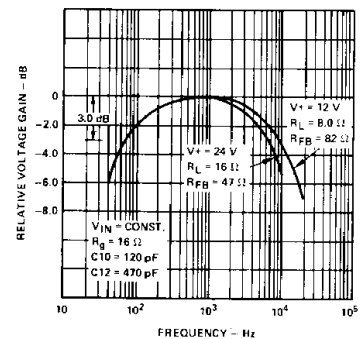

TYPICAL PERFORMANCE CURVES FOR TDA1190Z (Cont'd)

RELATIVE OVERALL VOLTAGE GAIN AS A FUNCTION OF FREQUENCY

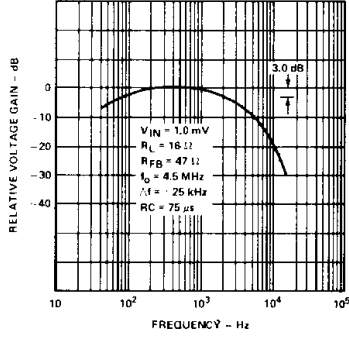

POWER SUPPLY RIPPLE REJECTION AS A FUNCTION OF RIPPLE FREQUENCY

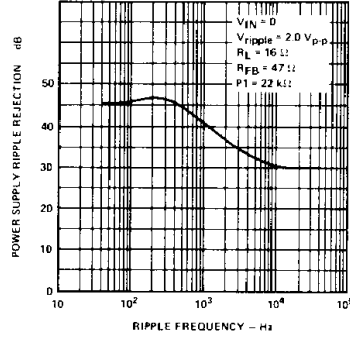

POWER SUPPLY RIPPLE REJECTION AS A FUNCTION OF VOLUME CONTROL ATTENUATION

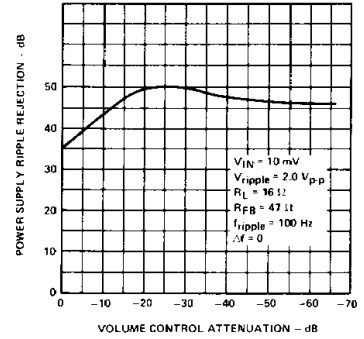

POWER OUTPUT AS A FUNCTION OF SUPPLY VOLTAGE

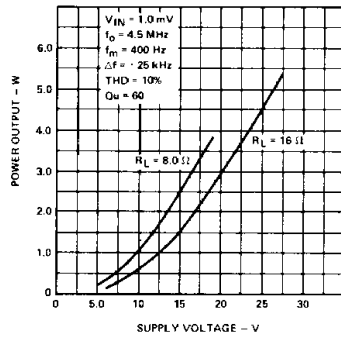

MAXIMUM POWER DISSIPATION AS A FUNCTION OF SUPPLY VOLTAGE (SINE WAVE OPERATION)

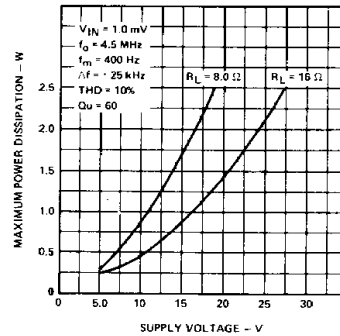

POWER DISSIPATION AND EFFICIENCY AS A FUNCTION OF POWER OUTPUT

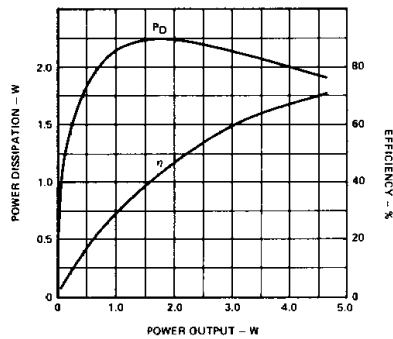

QUIESCENT OUTPUT VOLTAGE (PIN 9) AS A FUNCTION OF SUPPLY VOLTAGE

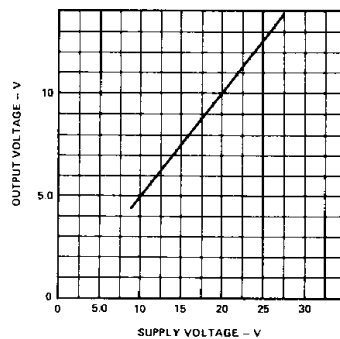

APPLICATIONS INFORMATION

The electrical characteristics of the TDA1190 and TDA1190Z remain almost constant over the frequency range 4.5 to 6.0 MHz, and therefore can be used in all television standards (FM mod.). They have a high input impedance to operate with a ceramic filter or with a tuned circuit that provides the necessary input selectivity.

The value of the resistors connected to pin 7 determines the AC gain of the audio frequency amplifier. With the TDA1190 (Figure 1), only one resistor (R_{FB}), is required to adjust the gain. The second resistor is included on the chip (typically 5.0 k Ω between pins 7 and 9). In the TDA1190Z (Figure 2), two resistors are required to adjust the gain (R_4 and R_{FB}). This arrangement provides more accurate adjustment of gain.

TYPICAL APPLICATIONS CIRCUIT – TDA1190

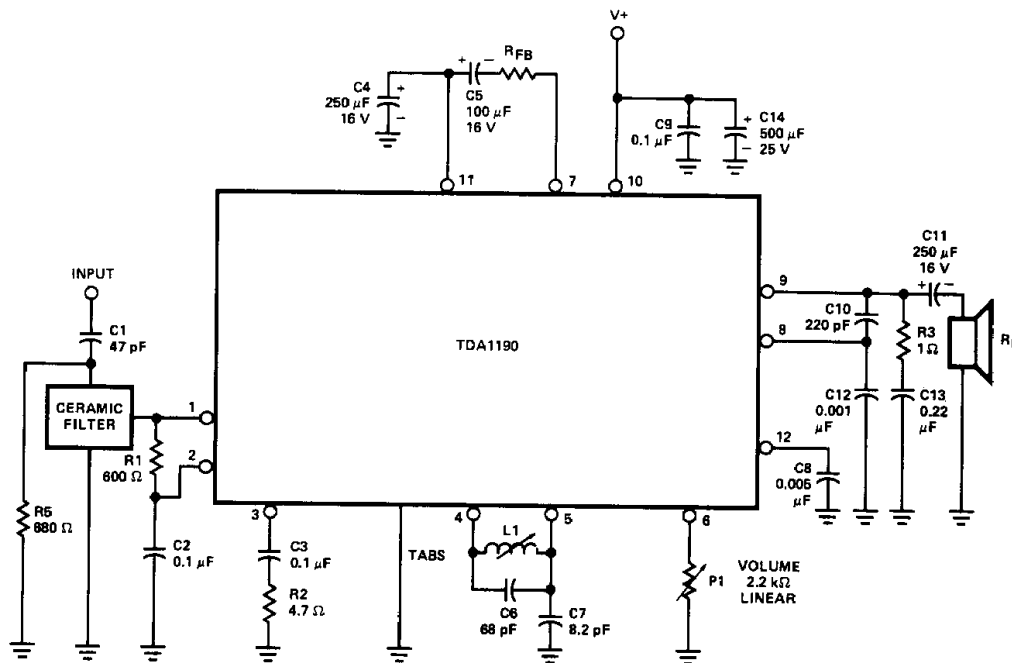

L1 = 12 μ H
 Qu = 80
 f_o = 5.5 MHz

V+	12	24	V
R _L	8	16	Ω
R _{FB}	18	10	Ω

Fig. 1

APPLICATIONS INFORMATION (Cont'd)

The desired gain should be selected in relation to the frequency deviation at which the AF amplifier's output stage starts clipping. The capacitance connected between pins 9 and 8 determines the upper cut-off frequency of the audio band. If larger bandwidth is required, C10/C12 must be reduced keeping the C12/C10 ratio as shown in figure 1 or figure 2. The capacitance connected between pin 12 and ground, together with the internal resistor of 10 kΩ, forms the de-emphasis network. The Boucherot cell eliminates the high frequency oscillations caused by the inductive load and the wires connecting the loudspeaker. (R3, C13).

The TDA1190Z is also designed to operate with a larger volume control resistance than the TDA1190 for those systems where this is desired. The typical volume control resistance for the TDA1190Z is 22 kΩ and for the TDA1190 it is 2.2 kΩ.

TYPICAL APPLICATIONS CIRCUIT – TDA1190Z

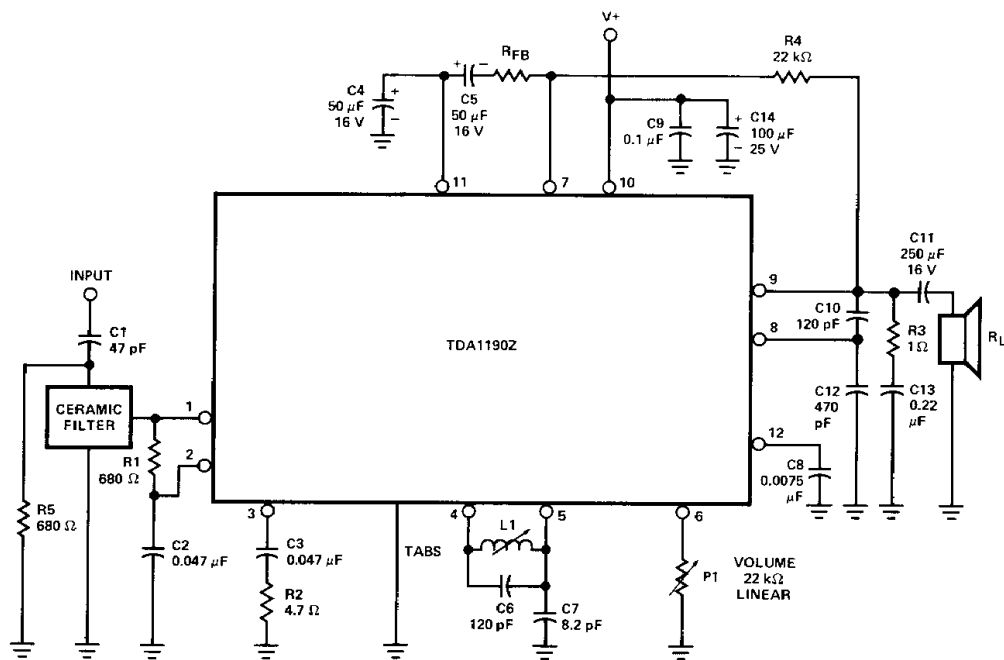

L1 = 10 μH
 Qu = 60
 f_o = 4.5 MHz

V+	12	24	V
R _L	8	16	Ω
R _{FB}	82	47	Ω

Fig. 2

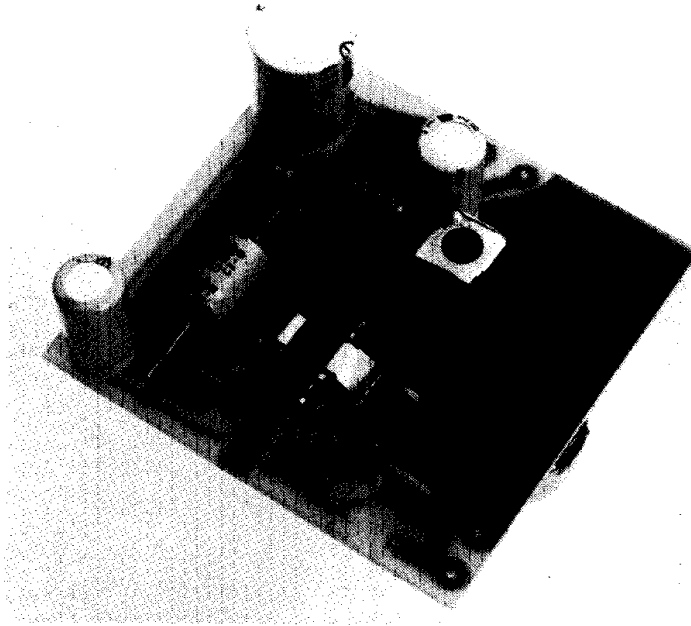
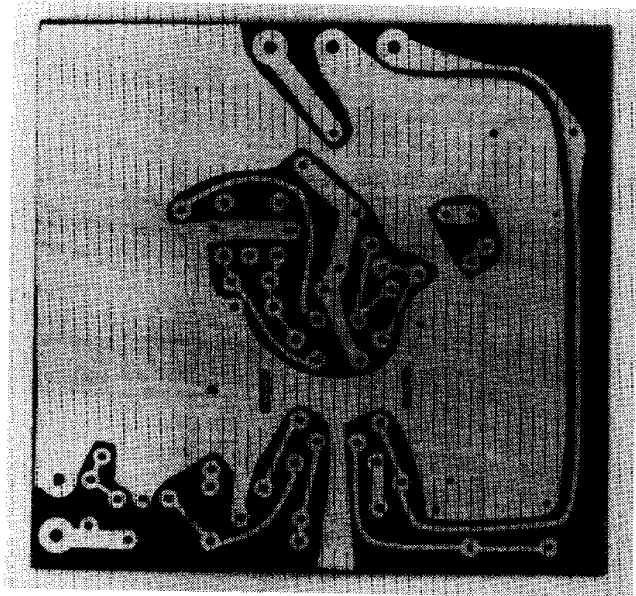
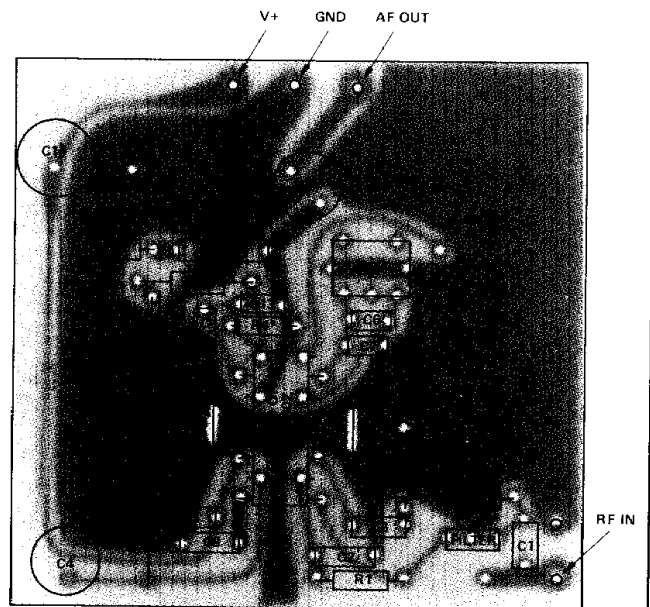

Fig. 3



P. C. BOARD
COPPER SIDE

Fig. 4



COMPONENTS LOCATION
(TOP VIEW)

Fig. 5

MOUNTING INSTRUCTION

The θ_{j-amb} of the TDA1190 and TDA1190Z can be reduced by soldering the tabs to a suitable copper area of the printed circuit board (Fig. 6) or to an external heatsink (Fig. 7). Figure 8 shows the maximum allowable power P_D and the θ_{j-amb} as a function of the side "L" of the two equal square copper areas having a thickness of 35μ (1.4 mils). During soldering the tab temperature must not exceed 260°C and the soldering time must not be longer than 10 seconds.

The external heatsink or printed circuit copper area must be connected to electrical ground.

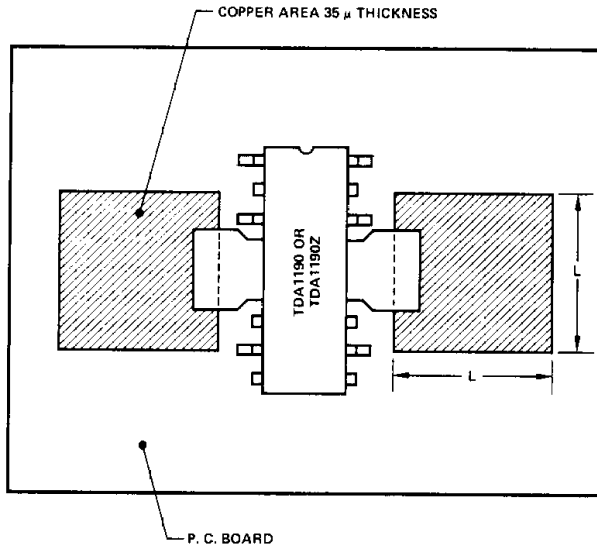

Fig. 6

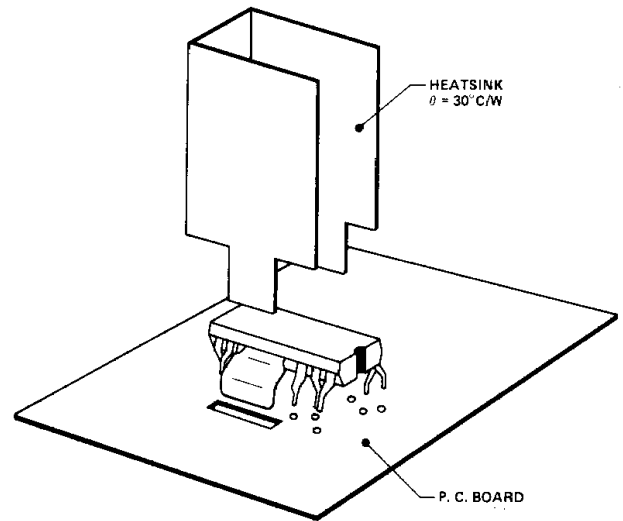

Fig. 7

MAXIMUM ALLOWABLE DISSIPATION AND θ_{j-amb} AS A FUNCTION OF COPPER LENGTH (SEE FIG. 6)

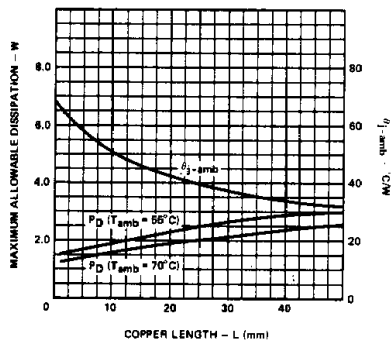

Fig. 8

MAXIMUM ALLOWABLE DISSIPATION AS A FUNCTION OF AMBIENT TEMPERATURE

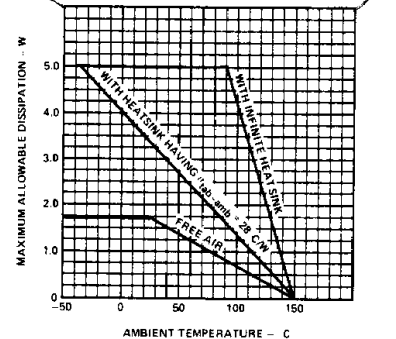

Fig. 9