



## STL60NH3LL

N-channel 30V - 0.0065Ω - 30A - PowerFLAT™ (6x5)  
Ultra low gate charge STripFET™ Power MOSFET

### General features

Type	V <sub>DSS</sub>	R <sub>DS(on)</sub>	I <sub>D</sub>
STL60NH3LL	30V	<0.0085Ω	16A <sup>(2)</sup>

- Improved die-to-footprint ratio
- Very low profile package (1mm max)
- Very low thermal resistance
- Very low gate charge
- Low threshold device

### Description

This application specific Power MOSFET is the latest generation of STMicroelectronics unique “STripFET™” technology. The resulting transistor is optimized for low on-resistance and minimal gate charge. The Chip-scaled PowerFLAT™ package allows a significant board space saving, still boosting the performance.

### Applications

- Switching application

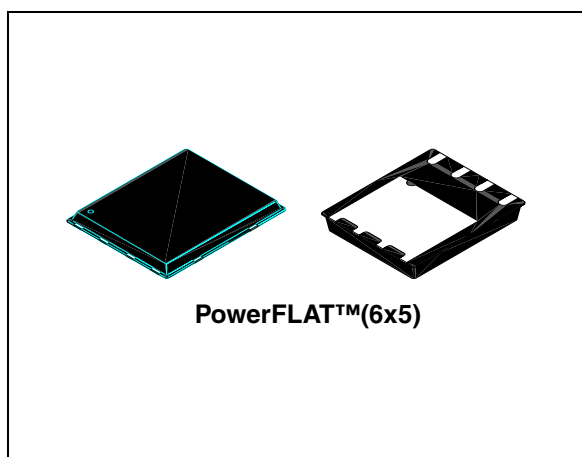

### Internal schematic diagram

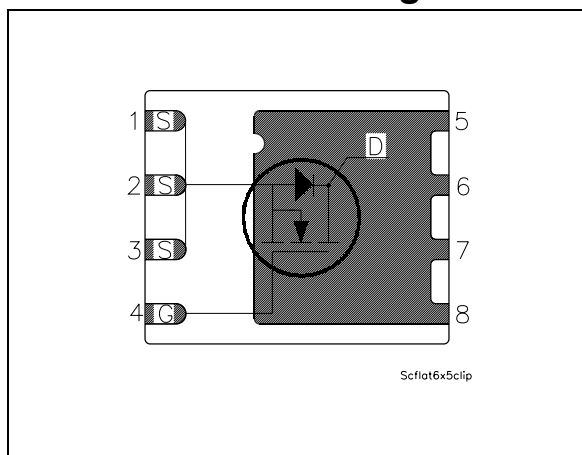

### Order codes

Part number	Marking	Package	Packaging
STL60NH3LL	L60NH3LL	PowerFLAT™ (6 x 5)	Tape & reel

## Contents

<b>1</b>	<b>Electrical ratings</b> .....	<b>3</b>
<b>2</b>	<b>Electrical characteristics</b> .....	<b>4</b>
	2.1 Electrical characteristics (curves) .....	6
<b>3</b>	<b>Test circuit</b> .....	<b>9</b>
<b>4</b>	<b>Package mechanical data</b> .....	<b>10</b>
<b>5</b>	<b>Revision history</b> .....	<b>12</b>

# 1 Electrical ratings

**Table 1. Absolute maximum ratings**

Symbol	Parameter	Value	Unit
$V_{DS}$	Drain-source voltage ( $V_{GS} = 0$ )	30	V
$V_{GS}$	Gate-source voltage	$\pm 16$	V
$I_D^{(1)}$	Drain current (continuous) at $T_C = 25^\circ\text{C}$	30	A
$I_D^{(1)}$	Drain current (continuous) at $T_C = 100^\circ\text{C}$	30	A
$I_D^{(2)}$	Drain current (continuous) at $T_C = 25^\circ\text{C}$	16	A
$I_{DM}^{(3)}$	Drain current (pulsed)	64	A
$P_{TOT}^{(1)}$	Total dissipation at $T_C = 25^\circ\text{C}$	60	W
$P_{TOT}^{(2)}$	Total dissipation at $T_C = 25^\circ\text{C}$	4	W
	Derating factor	0.03	W/ $^\circ\text{C}$
$T_j$ $T_{stg}$	Operating junction temperature Storage temperature	-55 to 150	$^\circ\text{C}$

1. The value is rated according  $R_{thj-C}$  and is limited by wire bonding.
2. This value is according  $R_{thj-pcb}$
3. Pulse width limited by safe operating area

**Table 2. Thermal resistance**

Symbol	Parameter	Value	Unit
$R_{thj-case}$	Thermal resistance junction-case (drain) Max	2.08	$^\circ\text{C}/\text{W}$
$R_{thj-pcb}^{(1)}$	Thermal resistance junction-pcb Max	31.3	$^\circ\text{C}/\text{W}$

1. When mounted on FR-4 board of 1inch<sup>2</sup>, 2 oz Cu,  $t < 10\text{sec}$

## 2 Electrical characteristics

( $T_{CASE}=25^{\circ}C$  unless otherwise specified)

**Table 3. On/off states**

Symbol	Parameter	Test conditions	Min.	Typ.	Max.	Unit
$V_{(BR)DSS}$	Drain-source breakdown voltage	$I_D = 250\mu A, V_{GS} = 0$	30			V
$I_{DSS}$	Zero gate voltage drain current ( $V_{GS} = 0$ )	$V_{DS} = \text{Max rating},$ $V_{DS} = \text{Max rating}, @ 125^{\circ}C$			1 10	$\mu A$ $\mu A$
$I_{GSS}$	Gate body leakage current ( $V_{DS} = 0$ )	$V_{DS} = \pm 16V$			$\pm 100$	nA
$V_{GS(th)}$	Gate threshold voltage	$V_{DS} = V_{GS}, I_D = 250\mu A$	1			V
$R_{DS(on)}$	Static drain-source on resistance	$V_{GS} = 10V, I_D = 8A$ $V_{GS} = 4.5V, I_D = 8A$		0.0065 0.0075	0.0085 0.0105	$\Omega$ $\Omega$

**Table 4. Dynamic**

Symbol	Parameter	Test conditions	Min.	Typ.	Max.	Unit
$C_{iss}$	Input capacitance	$V_{DS}=25V, f = 1MHz, V_{GS}=0$		1810		pF
$C_{oss}$	Output capacitance			565		pF
$C_{rss}$	Reverse transfer capacitance			41		pF
$Q_g$	Total gate charge	$V_{DD} = 15V, I_D = 16A,$ $V_{GS} = 4.5V$ (see Figure 15)		18	24	nC
$Q_{gs}$	Gate-source charge			4.8		nC
$Q_{gd}$	Gate-drain charge			5.3		nC
$R_G$	Gate input resistance	f=1 MHz Gate DC Bias = 0 Test signal level = 20mV open drain	0.5	1.5	3	$\Omega$

**Table 5. Switching times**

Symbol	Parameter	Test conditions	Min.	Typ.	Max.	Unit
$t_{d(on)}$ $t_r$	Turn-on delay time Rise time	$V_{DD} = 15V, I_D = 8A$ $R_G = 4.7\Omega, V_{GS} = 10V,$ (see Figure 14)		8 65		ns ns
$t_{d(off)}$ $t_f$	Turn-off delay time Fall time	$V_{DD} = 15V, I_D = 8A$ $R_G = 4.7\Omega, V_{GS} = 10V,$ (see Figure 14)		30 20		ns ns

**Table 6. Source drain diode**

Symbol	Parameter	Test conditions	Min	Typ.	Max	Unit
$I_{SD}$	Source-drain current				16	A
$I_{SDM}$	Source-drain current (pulsed)				64	A
$V_{SD}^{(1)}$	Forward on voltage	$I_{SD} = 16A, V_{GS} = 0$			1.3	V
$t_{rr}$	Reverse recovery time	$I_{SD} = 16V, di/dt = 100A/\mu s$		22		ns
$Q_{rr}$	Reverse recovery charge	$V_{DD} = 20V, T_j = 25^\circ C$		32		nC
$I_{RRM}$	Reverse recovery current	(see Figure 16)		1.9		A

1. Pulsed: Pulse duration = 300 $\mu s$ , duty cycle 1.5%

## 2.1 Electrical characteristics (curves)

Figure 1. Safe operating area

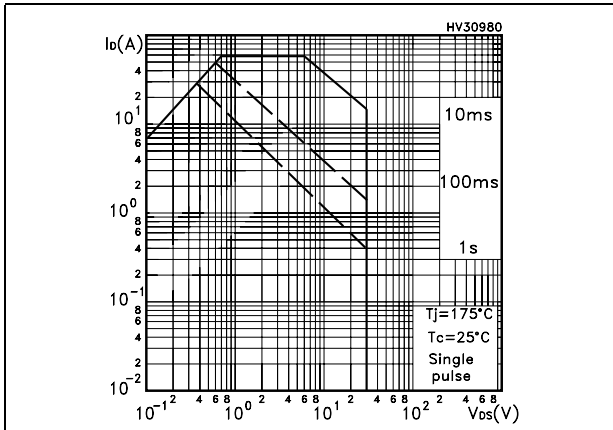

Figure 2. Thermal impedance

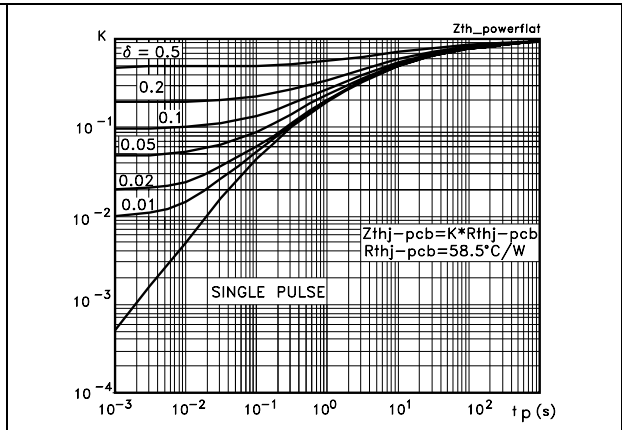

Figure 3. Output characteristics

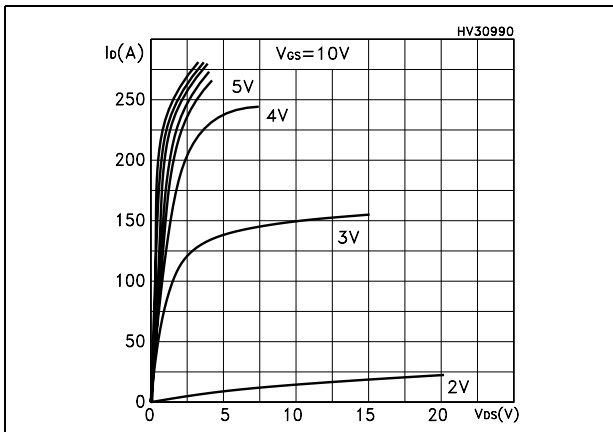

Figure 4. Transfer characteristics

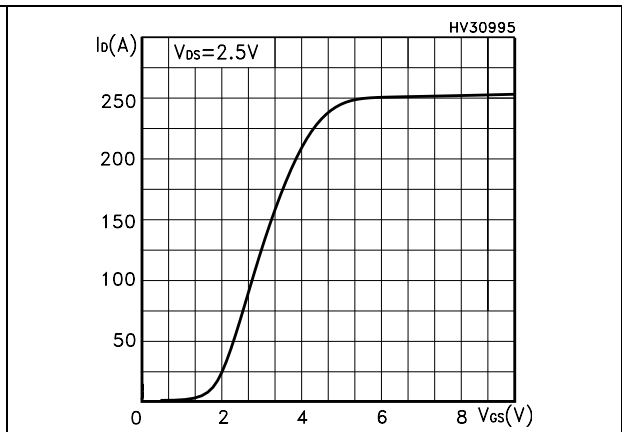

Figure 5. Normalized  $B_{V_{DS}}$  vs temperature

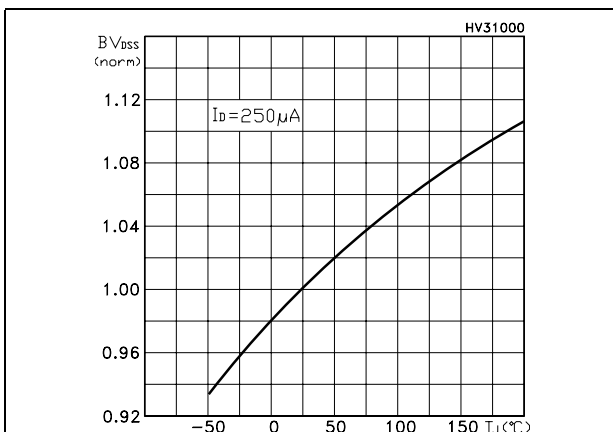

Figure 6. Static drain-source on resistance

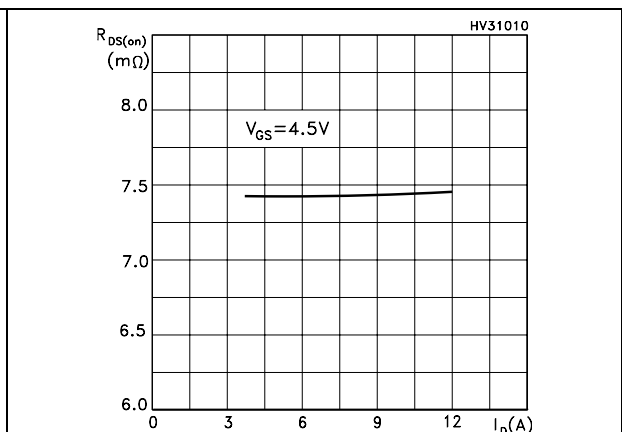

Figure 7. Gate charge vs gate-source voltage Figure 8. Capacitance variations

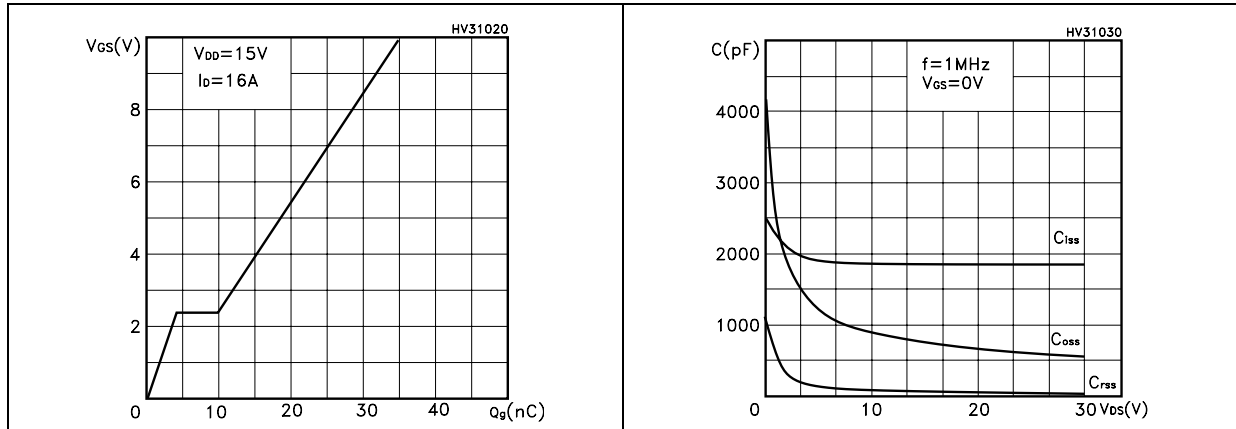

Figure 9. Normalized gate threshold voltage vs temperature Figure 10. Normalized on resistance vs temperature

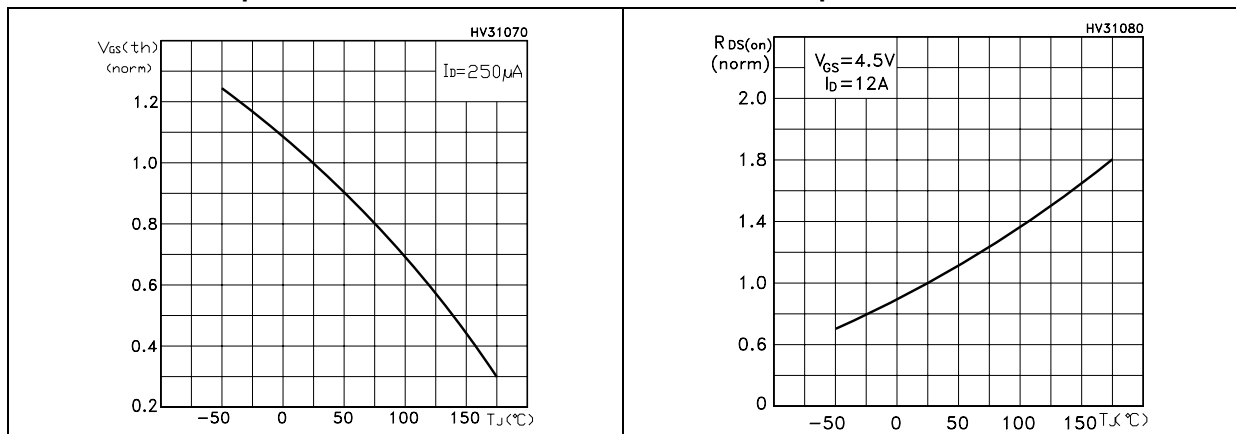

Figure 11. Source-drain diode forward characteristics

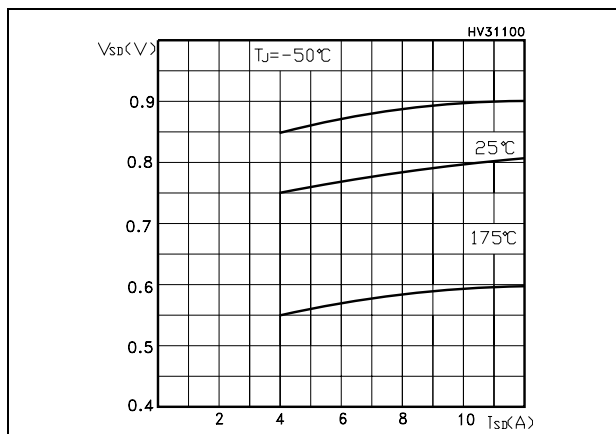
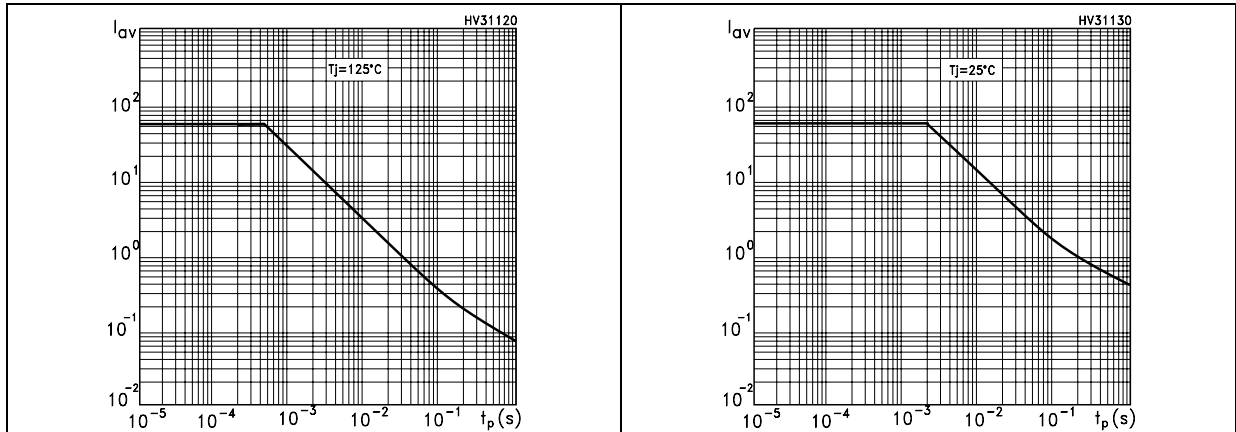

Figure 12. Allowable  $I_{AV}$  vs Time in Avalanche    Figure 13. Allowable  $I_{AV}$  vs Time in Avalanche



The previous curve gives the single pulse safe operating area for unclamped inductive loads under the following conditions:

$$P_{D(AVE)} = 0.5 \cdot (1.3 \cdot BV_{DSS} \cdot I_{AV})$$

$$E_{AS(AR)} = P_{D(AVE)} \cdot t_{AV}$$

Where:

$I_{AV}$  is the allowable current in avalanche

$P_{D(AVE)}$  is the average power dissipation in avalanche (single pulse)

$t_{AV}$  is the time in avalanche



### 3 Test circuit

Figure 14. Switching times test circuit for resistive load



Figure 15. Gate charge test circuit



Figure 16. Test circuit for inductive load switching and diode recovery times



Figure 17. Unclamped inductive load test circuit



Figure 18. Unclamped inductive waveform



Figure 19. Switching time waveform



## 4 Package mechanical data

In order to meet environmental requirements, ST offers these devices in ECOPACK® packages. These packages have a Lead-free second level interconnect . The category of second level interconnect is marked on the package and on the inner box label, in compliance with JEDEC Standard JESD97. The maximum ratings related to soldering conditions are also marked on the inner box label. ECOPACK is an ST trademark. ECOPACK specifications are available at: [www.st.com](http://www.st.com)

**PowerFLAT™ (6x5) MECHANICAL DATA**

DIM.	mm.			inch		
	MIN.	TYP.	MAX.	MIN.	TYP.	MAX.
A	0.80	0.83	0.93	0.031	0.032	0.036
A1		0.02	0.05		0.0007	0.0019
A3		0.20			0.007	
b	0.35	0.40	0.47	0.013	0.015	0.018
D		5.00			0.196	
D1		4.75			0.187	
D2	4.15	4.20	4.25	0.163	0.165	0.167
E		6.00			0.236	
E1		5.75			0.226	
E2	3.43	3.48	3.53	0.135	0.137	0.139
E4	2.58	2.63	2.68		0.103	0.105
e		1.27			0.050	
L	0.70	0.80	0.90	0.027	0.031	0.035

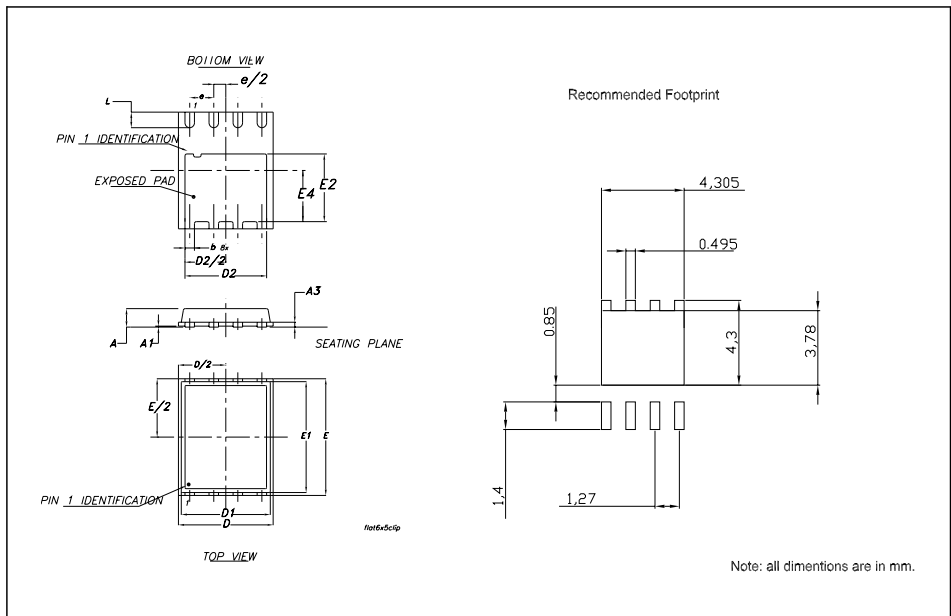

## 5 Revision history

Table 7. Revision history

Date	Revision	Changes
10-Jan-2006	1	First release
14-Apr-2006	2	New footprint
03-Jul-2006	3	New Ecopack label
01-Aug-2006	4	Modified <i>Figure 1.</i> and <i>Figure 2.</i>
05-Sep-2006	5	New template, no content change

**Please Read Carefully:**

Information in this document is provided solely in connection with ST products. STMicroelectronics NV and its subsidiaries ("ST") reserve the right to make changes, corrections, modifications or improvements, to this document, and the products and services described herein at any time, without notice.

All ST products are sold pursuant to ST's terms and conditions of sale.

Purchasers are solely responsible for the choice, selection and use of the ST products and services described herein, and ST assumes no liability whatsoever relating to the choice, selection or use of the ST products and services described herein.

No license, express or implied, by estoppel or otherwise, to any intellectual property rights is granted under this document. If any part of this document refers to any third party products or services it shall not be deemed a license grant by ST for the use of such third party products or services, or any intellectual property contained therein or considered as a warranty covering the use in any manner whatsoever of such third party products or services or any intellectual property contained therein.

**UNLESS OTHERWISE SET FORTH IN ST'S TERMS AND CONDITIONS OF SALE ST DISCLAIMS ANY EXPRESS OR IMPLIED WARRANTY WITH RESPECT TO THE USE AND/OR SALE OF ST PRODUCTS INCLUDING WITHOUT LIMITATION IMPLIED WARRANTIES OF MERCHANTABILITY, FITNESS FOR A PARTICULAR PURPOSE (AND THEIR EQUIVALENTS UNDER THE LAWS OF ANY JURISDICTION), OR INFRINGEMENT OF ANY PATENT, COPYRIGHT OR OTHER INTELLECTUAL PROPERTY RIGHT.**

**UNLESS EXPRESSLY APPROVED IN WRITING BY AN AUTHORIZED ST REPRESENTATIVE, ST PRODUCTS ARE NOT RECOMMENDED, AUTHORIZED OR WARRANTED FOR USE IN MILITARY, AIR CRAFT, SPACE, LIFE SAVING, OR LIFE SUSTAINING APPLICATIONS, NOR IN PRODUCTS OR SYSTEMS WHERE FAILURE OR MALFUNCTION MAY RESULT IN PERSONAL INJURY, DEATH, OR SEVERE PROPERTY OR ENVIRONMENTAL DAMAGE. ST PRODUCTS WHICH ARE NOT SPECIFIED AS "AUTOMOTIVE GRADE" MAY ONLY BE USED IN AUTOMOTIVE APPLICATIONS AT USER'S OWN RISK.**

Resale of ST products with provisions different from the statements and/or technical features set forth in this document shall immediately void any warranty granted by ST for the ST product or service described herein and shall not create or extend in any manner whatsoever, any liability of ST.

ST and the ST logo are trademarks or registered trademarks of ST in various countries.

Information in this document supersedes and replaces all information previously supplied.

The ST logo is a registered trademark of STMicroelectronics. All other names are the property of their respective owners.

© 2006 STMicroelectronics - All rights reserved

STMicroelectronics group of companies

Australia - Belgium - Brazil - Canada - China - Czech Republic - Finland - France - Germany - Hong Kong - India - Israel - Italy - Japan - Malaysia - Malta - Morocco - Singapore - Spain - Sweden - Switzerland - United Kingdom - United States of America

[www.st.com](http://www.st.com)

