

FAN7382

High- and Low-Side Gate Driver



Features

- Floating Channels Designed for Bootstrap Operation to +600V
- Typically 350mA/650mA Sourcing/Sinking Current Driving Capability for Both Channels
- Common-Mode dv/dt Noise Canceling Circuit
- Extended Allowable Negative V_S Swing to -9.8V for Signal Propagation at $V_{CC}=V_{BS}=15V$
- V_{CC} & V_{BS} Supply Range from 10V to 20V
- UVLO Functions for Both Channels
- TTL Compatible Input Logic Threshold Levels
- Matched Propagation Delay Below 50nsec
- Output In-phase with Input Signal

Description

The FAN7382, a monolithic high and low side gate-drive IC, can drive MOSFETs and IGBTs that operate up to +600V. Fairchild's high-voltage process and common-mode noise canceling technique provides stable operation of the high-side driver under high-dv/dt noise circumstances. An advanced level-shift circuit allows high-side gate driver operation up to $V_S=-9.8V$ (typical) for $V_{BS}=15V$. The input logic level is compatible with standard TTL-series logic gates. UVLO circuits for both channels prevent malfunction when V_{CC} or V_{BS} is lower than the specified threshold voltage. Output drivers typically source/sink 350mA/650mA, respectively, which is suitable for fluorescent lamp ballasts, PDP scan drivers, motor controls, etc.

Applications

- PDP Scan Driver
- Fluorescent Lamp Ballast
- SMPS
- Motor Driver

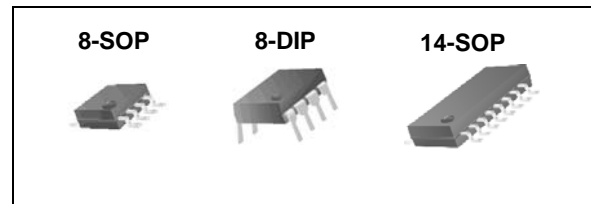

Ordering Information

Part Number	Package	Pb-Free	Operating Temperature Range	Packing Method
FAN7382N	8-DIP	Yes	-40°C ~ 125°C	Tube
FAN7382M ⁽¹⁾	8-SOP			Tube
FAN7382MX ⁽¹⁾				Tape & Reel
FAN7382M1 ⁽¹⁾	14-SOP			Tube
FAN7382M1X ⁽¹⁾				Tape & Reel

Note:

1. These devices passed wave soldering test by JESD22A-111.

Typical Application Circuit

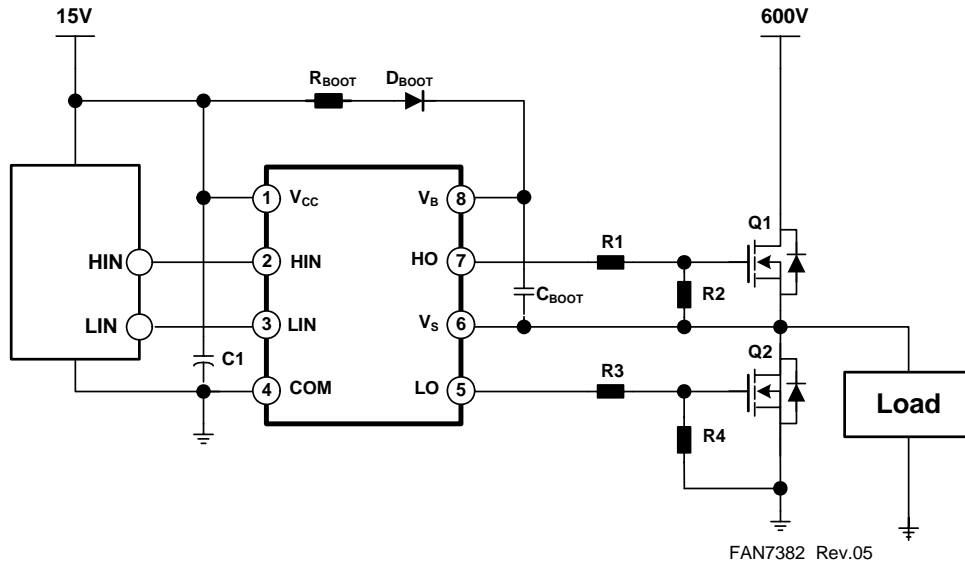

Figure 1. Application Circuit for Half-Bridge

Internal Block Diagram

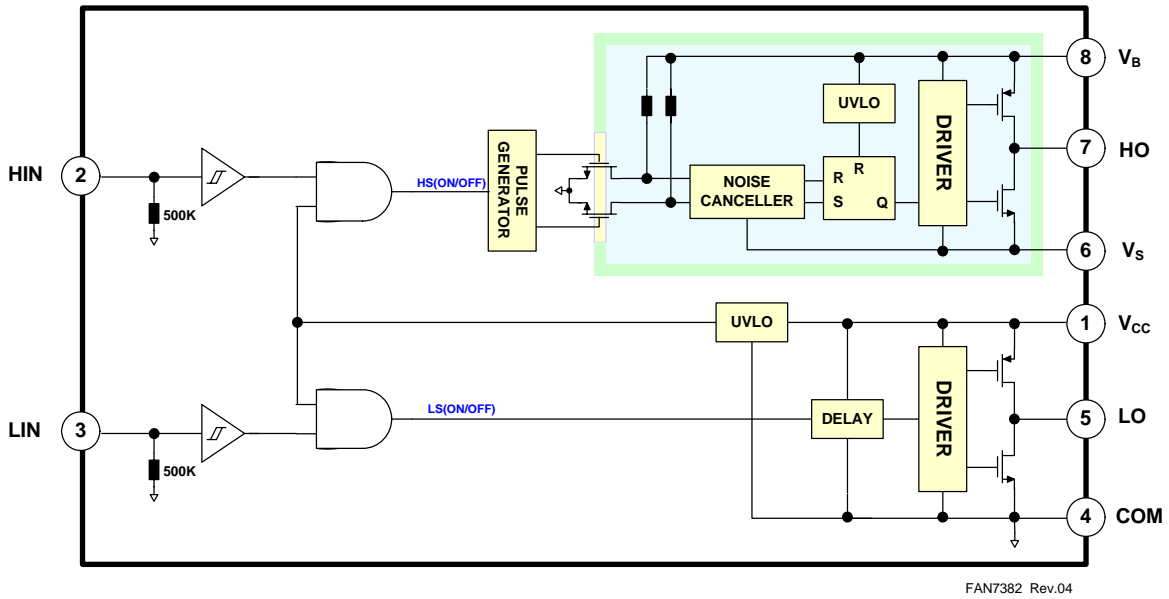

Figure 2. Functional Block Diagram

Pin Assignments

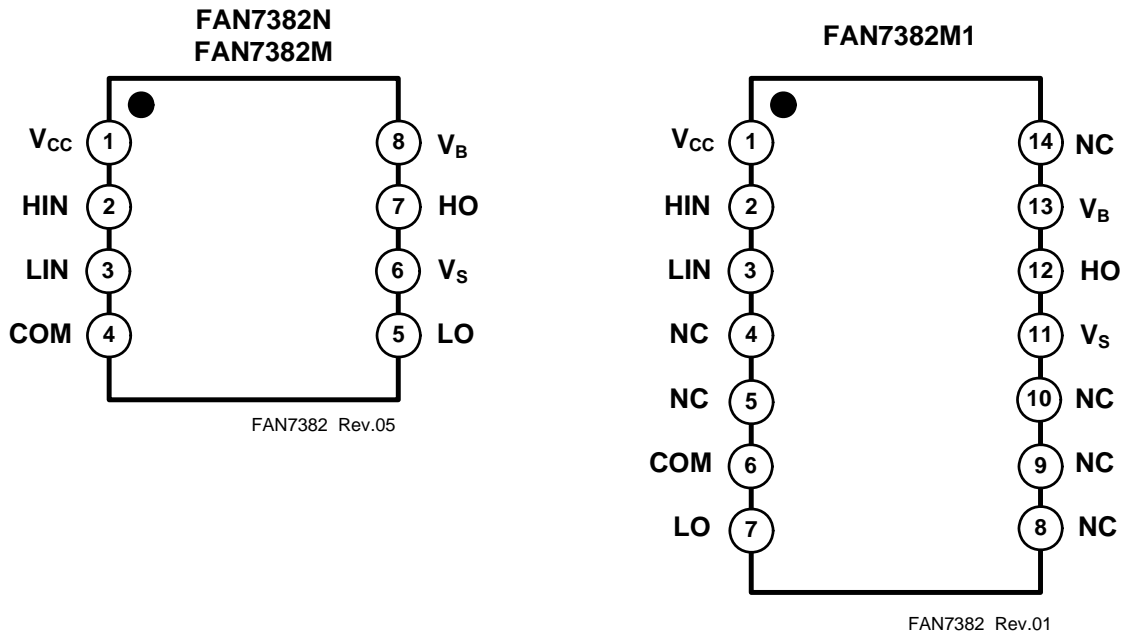

Figure 3. Pin Configuration (Top View)

Pin Definitions

Name	Description
V _{CC}	Low-Side Supply Voltage
HIN	Logic Input for High-Side Gate Driver Output
LIN	Logic Input for Low-Side Gate Driver Output
COM	Logic Ground and Low-Side Driver Return
LO	Low-Side Driver Output
V _S	High-Voltage Floating Supply Return
HO	High-Side Driver Output
V _B	High-Side Floating Supply

Absolute Maximum Ratings

Stresses exceeding the absolute maximum ratings may damage the device. The device may not function or be operable above the recommended operating conditions and stressing the parts to these levels is not recommended. In addition, extended exposure to stresses above the recommended operating conditions may affect device reliability. The absolute maximum ratings are stress ratings only.

Symbol	Characteristics	Min.	Max.	Unit
V_S	High-side offset voltage	V_B-25	$V_B+0.3$	V
V_B	High-side floating supply voltage	-0.3	625	
V_{HO}	High-side floating output voltage HO	$V_S-0.3$	$V_B+0.3$	
V_{CC}	Low-side and logic fixed supply voltage	-0.3	25	
V_{LO}	Low-side output voltage LO	-0.3	$V_{CC}+0.3$	
V_{IN}	Logic input voltage (HIN, LIN)	-0.3	$V_{CC}+0.3$	
COM	Logic ground	$V_{CC}-25$	$V_{CC}+0.3$	
dV_S/dt	Allowable offset voltage slew rate		50	V/ns
$P_D^{(2)(3)(4)}$	Power dissipation	8-SOP	0.625	W
		14-SOP	1.0	
		8-DIP	1.2	
θ_{JA}	Thermal resistance, junction-to-ambient	8-SOP	200	°C/W
		14-SOP	110	
		8-DIP	100	
T_J	Junction temperature		150	°C
T_{STG}	Storage temperature		150	°C

Notes:

- Mounted on 76.2 x 114.3 x 1.6mm PCB (FR-4 glass epoxy material).
- Refer to the following standards:
 - JESD51-2: Integral circuits thermal test method environmental conditions - natural convection
 - JESD51-3: Low effective thermal conductivity test board for leaded surface mount packages
- Do not exceed P_D under any circumstances.

Recommended Operating Ratings

The Recommended Operating Conditions table defines the conditions for actual device operation. Recommended operating conditions are specified to ensure optimal performance to the datasheet specifications. Fairchild does not recommend exceeding them or designing to Absolute Maximum Ratings.

Symbol	Parameter	Min.	Max.	Unit
V_B	High-side floating supply voltage	V_S+10	V_S+20	V
V_S	High-side floating supply offset voltage	$6-V_{CC}$	600	
V_{HO}	High-side (HO) output voltage	V_S	V_B	
V_{LO}	Low-side (LO) output voltage	COM	V_{CC}	
V_{IN}	Logic input voltage (HIN, LIN)	COM	V_{CC}	
V_{CC}	Low-side supply voltage	10	20	
T_A	Ambient temperature	-40	125	°C

Electrical Characteristics

V_{BIAS} (V_{CC} , V_{BS})=15.0V, $T_A = 25^\circ\text{C}$, unless otherwise specified. The V_{IN} and I_{IN} parameters are referenced to COM. The V_O and I_O parameters are referenced to V_S and COM and are applicable to the respective outputs HO and LO.

Symbol	Characteristics	Test Condition	Min.	Typ.	Max.	Unit
V_{CCUV+} V_{BSUV+}	V_{CC} and V_{BS} supply under-voltage positive going threshold		8.2	9.2	10.0	V
V_{CCUV-} V_{BSUV-}	V_{CC} and V_{BS} supply under-voltage negative going threshold		7.6	8.7	9.6	
V_{CCUVH} V_{BSUVH}	V_{CC} supply under-voltage lockout hysteresis			0.6		
I_{LK}	Offset supply leakage current	$V_B=V_S=600\text{V}$			50	μA
I_{QBS}	Quiescent V_{BS} supply current	$V_{IN}=0\text{V}$ or 5V		45	120	
I_{QCC}	Quiescent V_{CC} supply current	$V_{IN}=0\text{V}$ or 5V		70	180	
I_{PBS}	Operating V_{BS} supply current	$f_{IN}=20\text{kHz}$, rms value			600	μA
I_{PCC}	Operating V_{CC} supply current	$f_{IN}=20\text{kHz}$, rms value			600	
V_{IH}	Logic "1" input voltage		2.9			V
V_{IL}	Logic "0" input voltage				0.8	
V_{OH}	High-level output voltage, $V_{BIAS}-V_O$	$I_O=20\text{mA}$			1.0	
V_{OL}	Low-level output voltage, V_O				0.6	
I_{IN+}	Logic "1" input bias current	$V_{IN}=5\text{V}$		10	20	μA
I_{IN-}	Logic "0" input bias current	$V_{IN}=0\text{V}$		1.0	2.0	
I_{O+}	Output high short-circuit pulsed current	$V_O=0\text{V}$, $V_{IN}=5\text{V}$ with $PW<10\mu\text{s}$	250	350		mA
I_{O-}	Output low short-circuit pulsed current	$V_O=15\text{V}$, $V_{IN}=0\text{V}$ with $PW<10\mu\text{s}$	500	650		
V_S	Allowable negative V_S pin voltage for HIN signal propagation to HO			-9.8	-7.0	V

Dynamic Electrical Characteristics

V_{BIAS} (V_{CC} , V_{BS})=15.0V, $V_S=COM$, $C_L=1000\text{pF}$ and, $T_A = 25^\circ\text{C}$, unless otherwise specified.

Symbol	Characteristics	Test Condition	Min.	Typ.	Max.	Unit
t_{on}	Turn-on propagation delay	$V_S=0\text{V}$	100	170	300	ns
t_{off}	Turn-off propagation delay	$V_S=0\text{V}$ or $600\text{V}^{(5)}$	100	200	300	
t_r	Turn-on rise time		20	60	140	
t_f	Turn-off fall time			30	80	
MT	Delay matching, HS & LS turn-on/off				50	

Note:

5. This parameter guaranteed by design.

Typical Characteristics

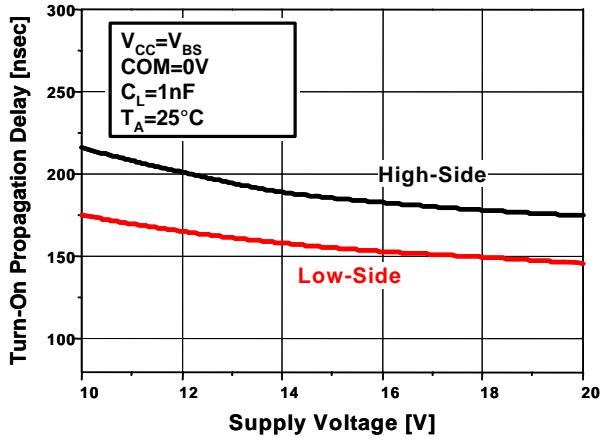

Figure 4. Turn-On Propagation Delay vs. Supply Voltage

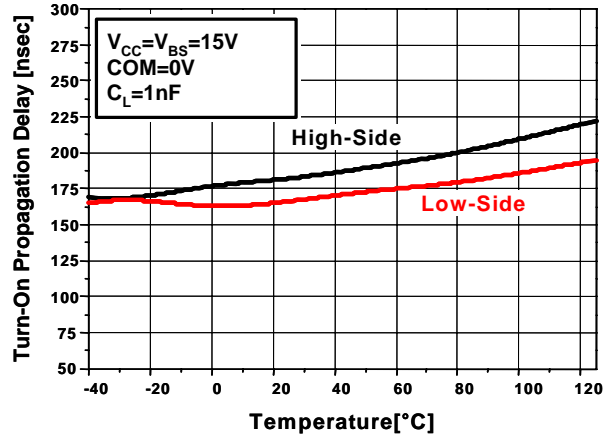

Figure 5. Turn-On Propagation Delay vs. Temp.

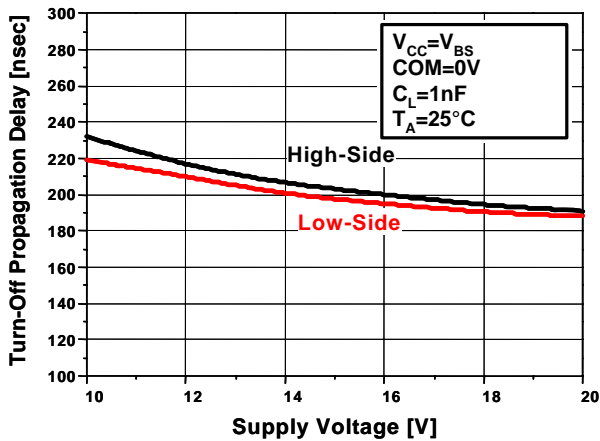

Figure 6. Turn-Off Propagation Delay vs. Supply Voltage

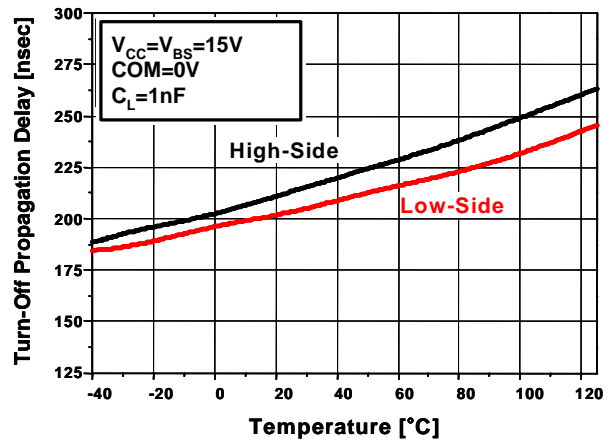

Figure 7. Turn-Off Propagation Delay vs. Temp.

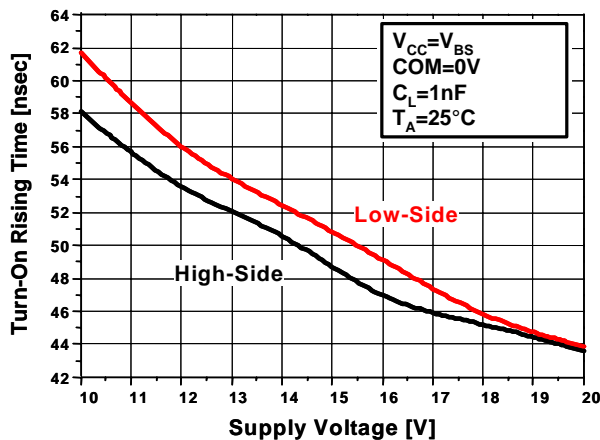

Figure 8. Turn-On Rising Time vs. Supply Voltage

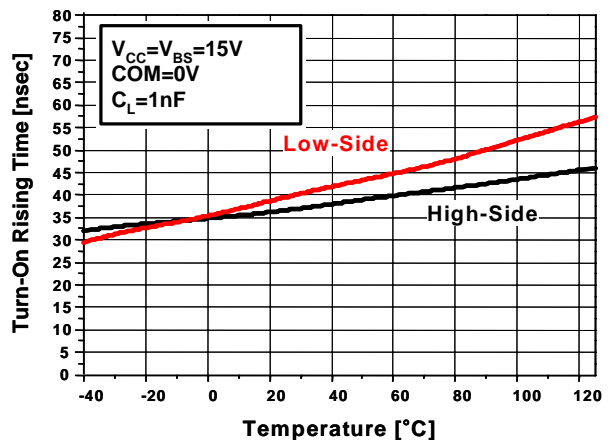

Figure 9. Turn-On Rising Time vs. Temp.

Typical Characteristics (Continued)

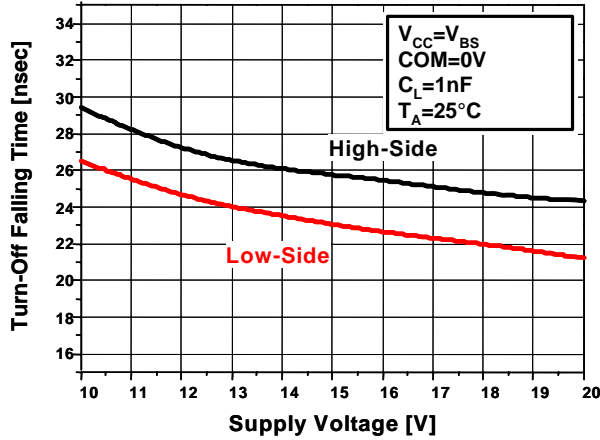

Figure 10. Turn-Off Falling Time vs. Supply Voltage

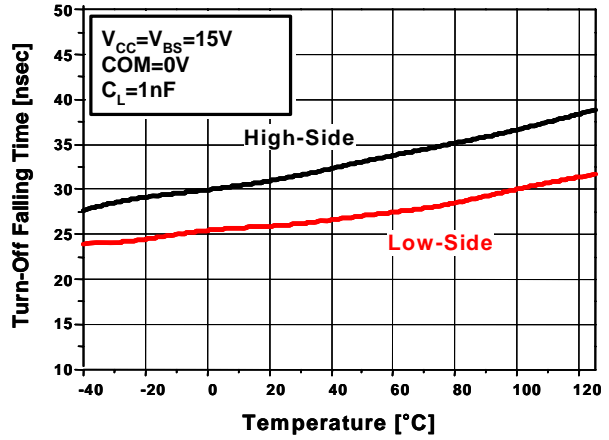

Figure 11. Turn-Off Falling Time vs. Temp.

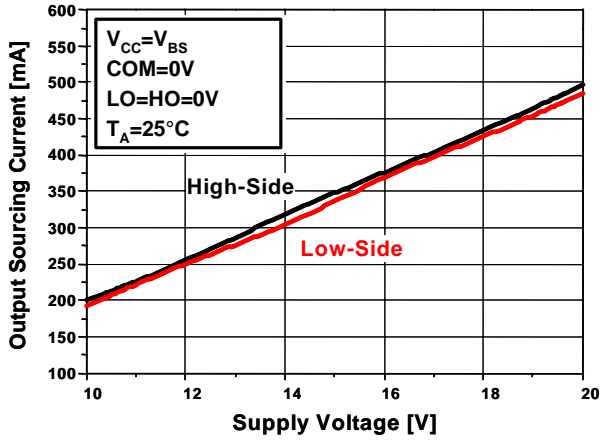

Figure 12. Output Sourcing Current vs. Supply Voltage

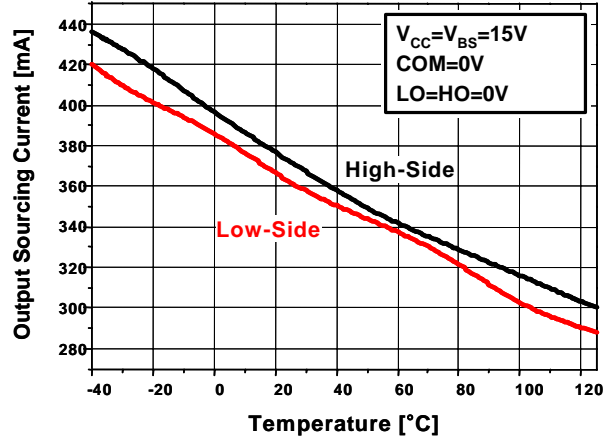

Figure 13. Output Sourcing Current vs. Temp

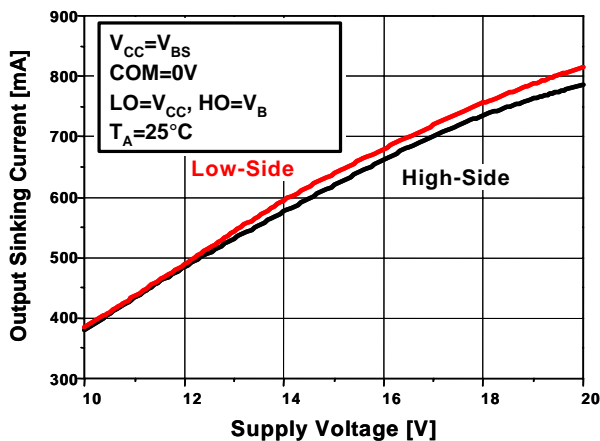

Figure 14. Output Sinking Current vs. Supply Voltage

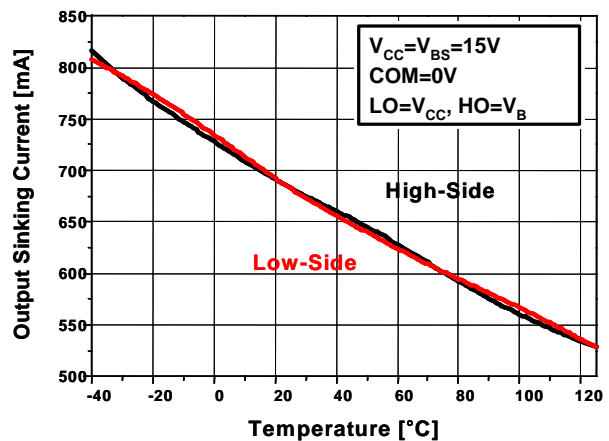

Figure 15. Output Sinking Current vs. Temp.

Typical Characteristics (Continued)

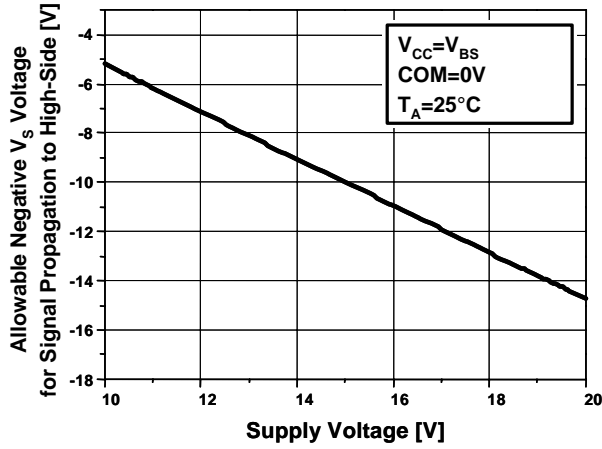

Figure 16. Allowable Negative V_S Voltage for Signal Propagation to High Side vs. Supply Voltage

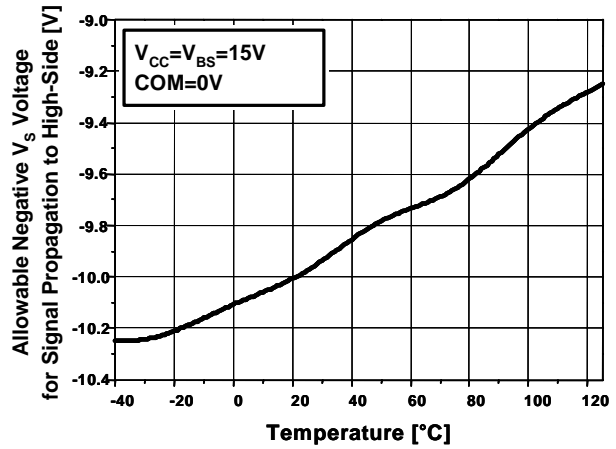

Figure 17. Allowable Negative V_S Voltage for Signal Propagation to High Side vs. Temp.

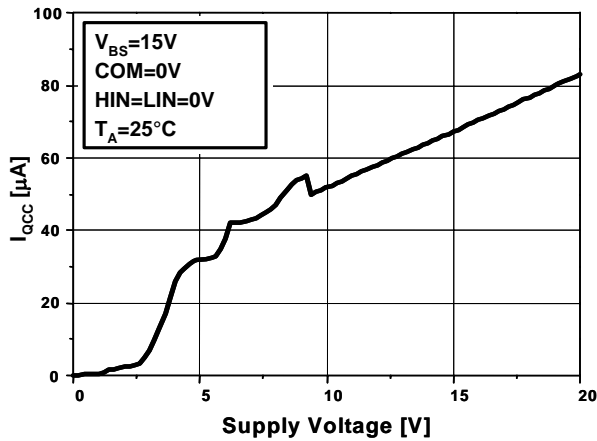

Figure 18. I_{QCC} vs. Supply Voltage

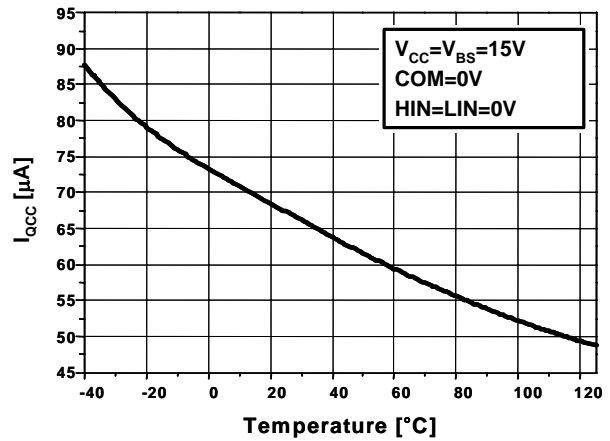

Figure 19. I_{QCC} vs. Temp.

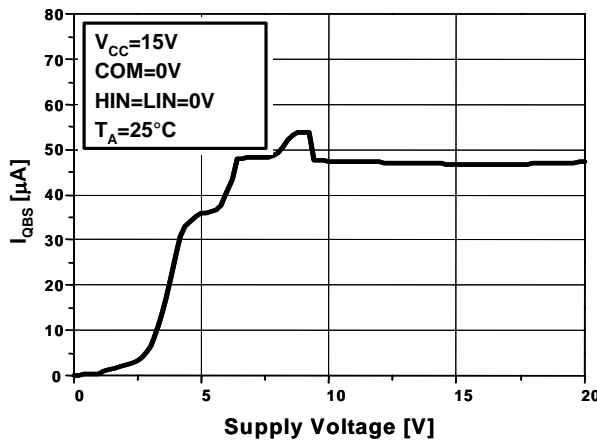

Figure 20. I_{QBS} vs. Supply Voltage

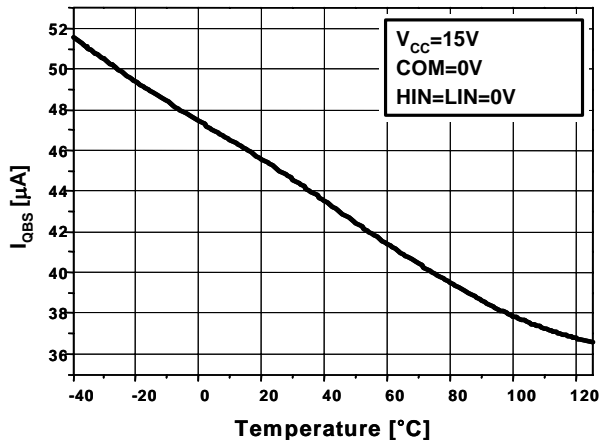

Figure 21. I_{QBS} vs. Temp.

Typical Characteristics (Continued)

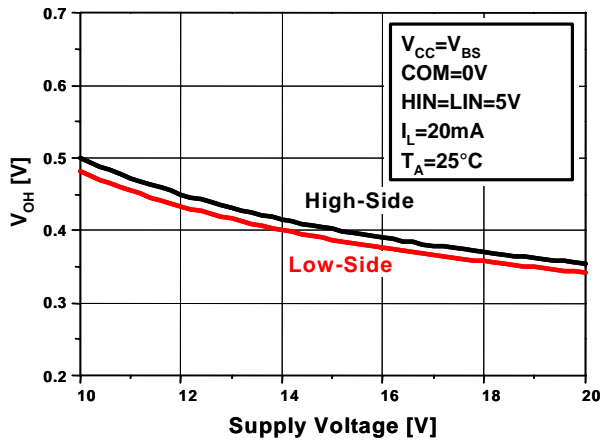

Figure 22. High-Level Output Voltage vs. Supply Voltage

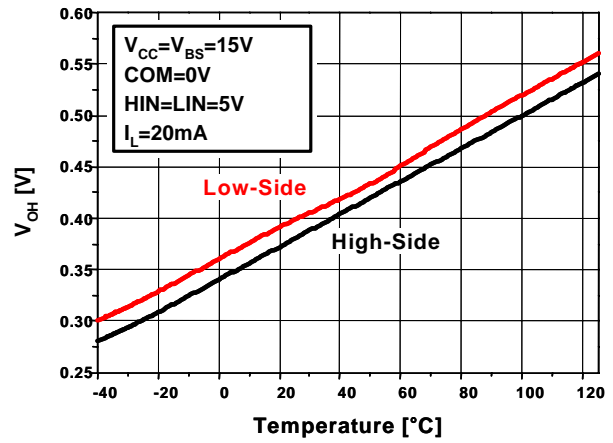

Figure 23. High-Level Output Voltage vs. Temp.

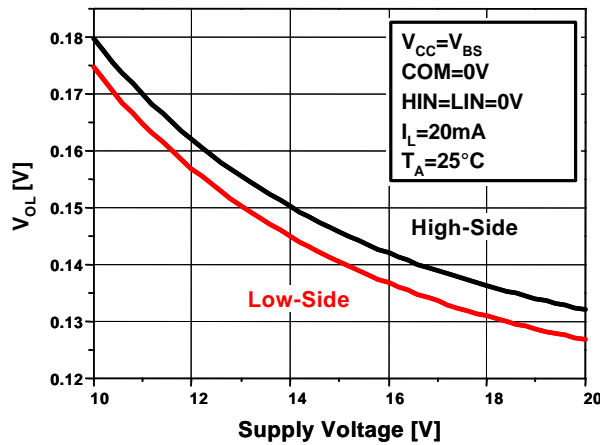

Figure 24. Low-Level Output Voltage vs. Supply Voltage

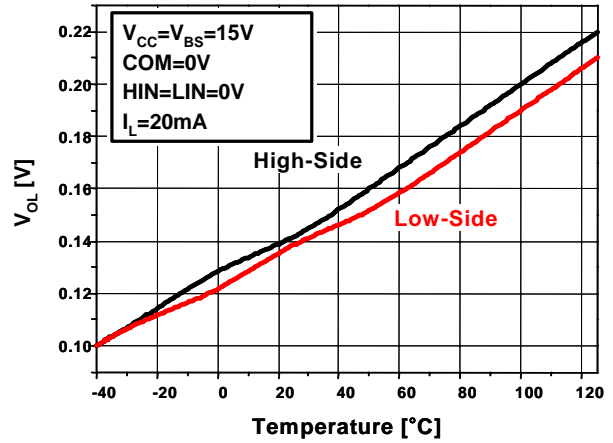

Figure 25. Low-Level Output Voltage vs. Temp.

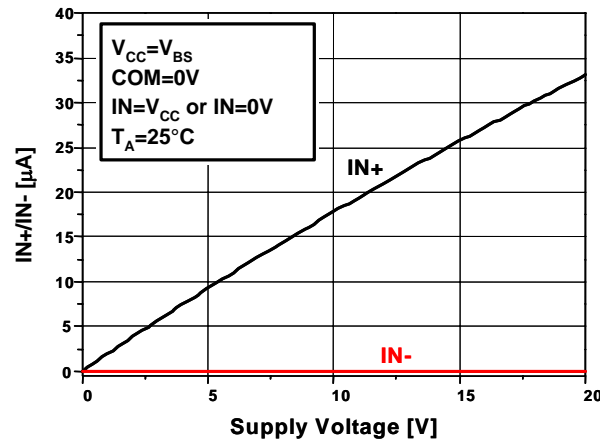

Figure 26. Input Bias Current vs. Supply Voltage

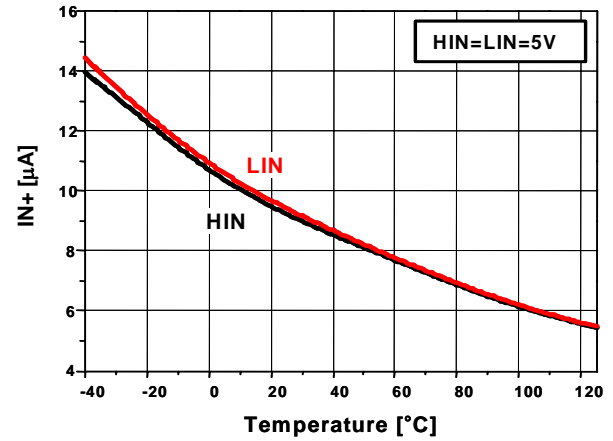

Figure 27. Input Bias Current vs. Temp.

Typical Characteristics (Continued)

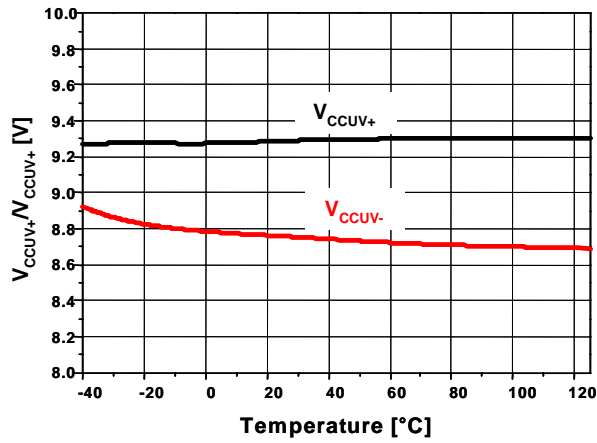

Figure 28. V_{CC} UVLO Threshold Voltage vs. Temp.

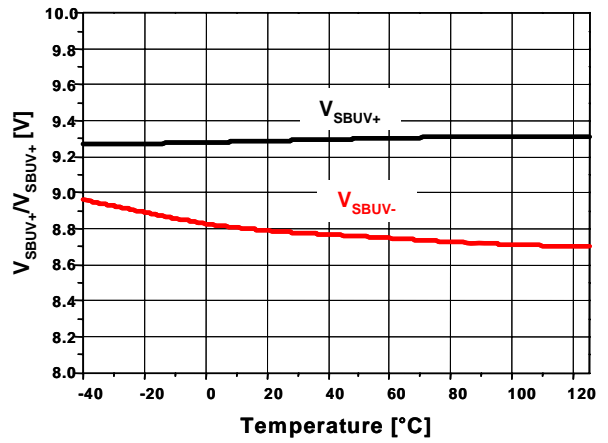

Figure 29. V_{BS} UVLO Threshold Voltage vs. Temp.

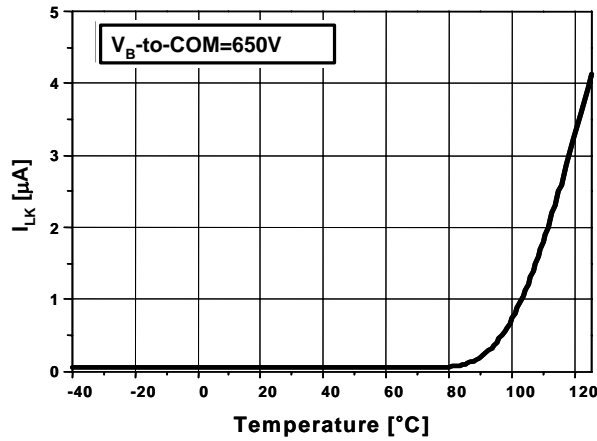

Figure 30. V_B to COM Leakage Current vs. Temp.

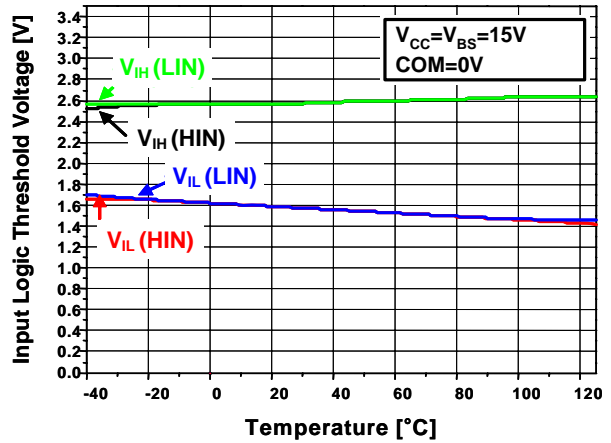

Figure 31. Input Logic Threshold Voltage vs. Temp.

Typical Characteristics (Continued)

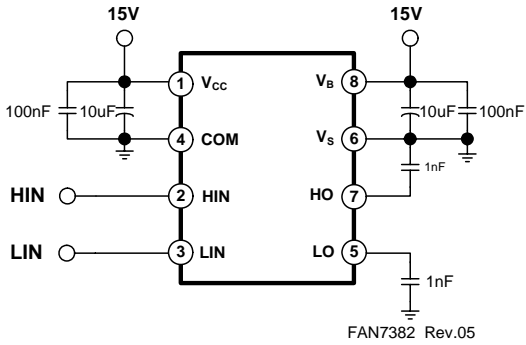

Figure 32. Switching Time Test Circuit

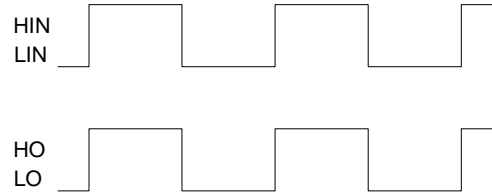

Figure 33. Input / Output Timing Diagram

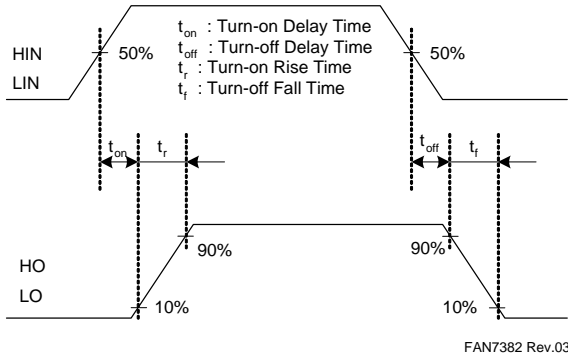

Figure 34. Switching Time Waveform Definition

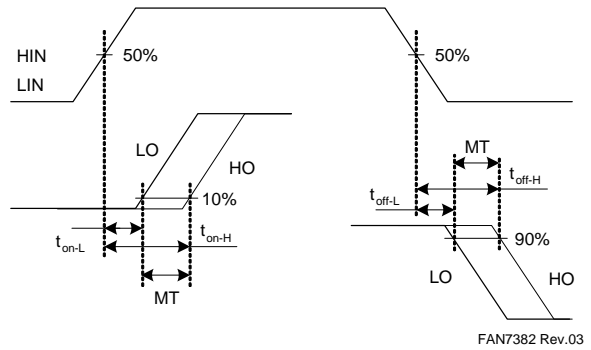
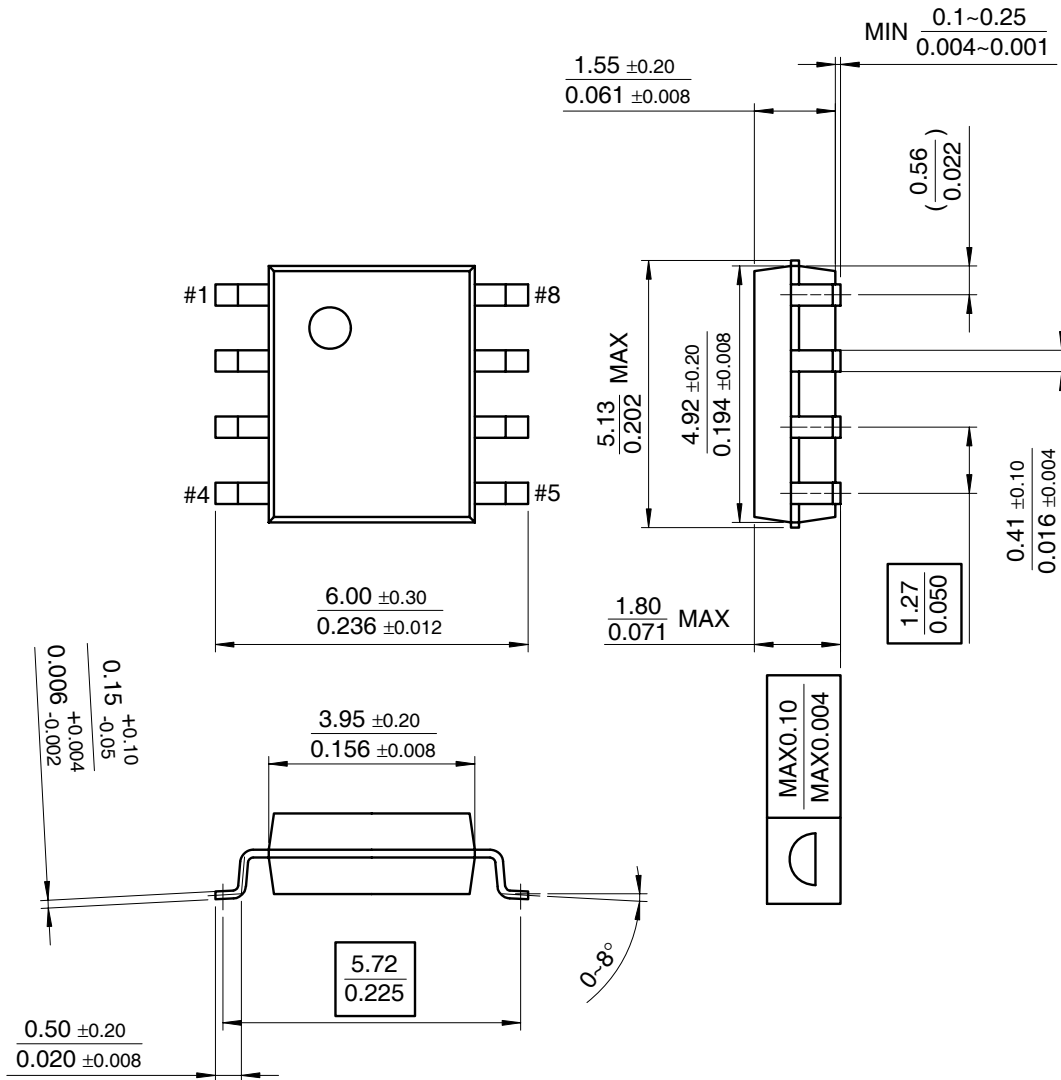

Figure 35. Delay Matching Waveform Definition

Mechanical Dimensions

8-SOP

Dimensions are in millimeters (inches) unless otherwise noted.



September 2001, Rev B1
sop8_dim.pdf

Figure 36. 8-Lead Small Outline Package

Mechanical Dimensions (Continued)

8-DIP

Dimensions are in millimeters (inches) unless otherwise noted.

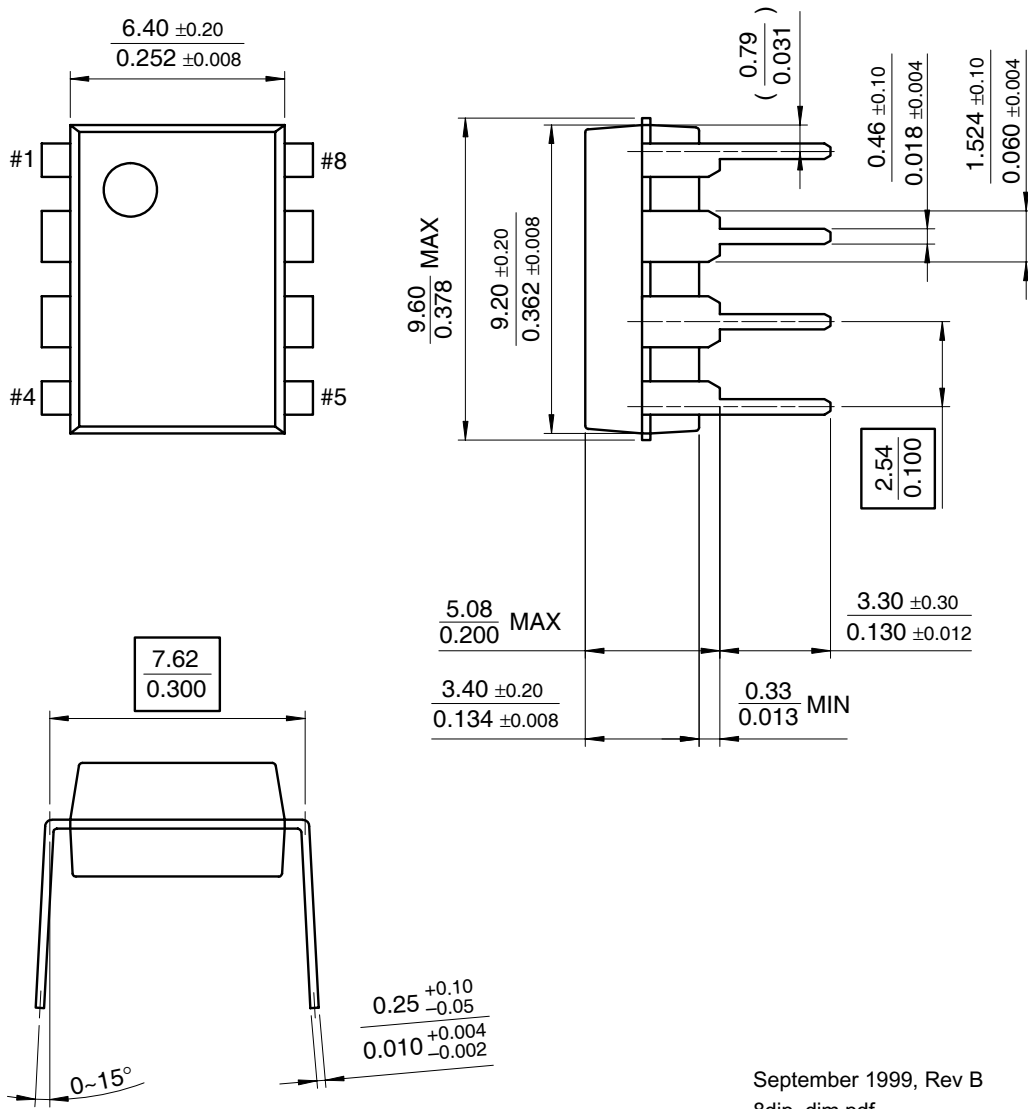

September 1999, Rev B
8dip_dim.pdf

Figure 37. 8-Lead Dual In-Line Package

Mechanical Dimensions (Continued)

14-SOP

Dimensions are in millimeters (inches) unless otherwise noted.

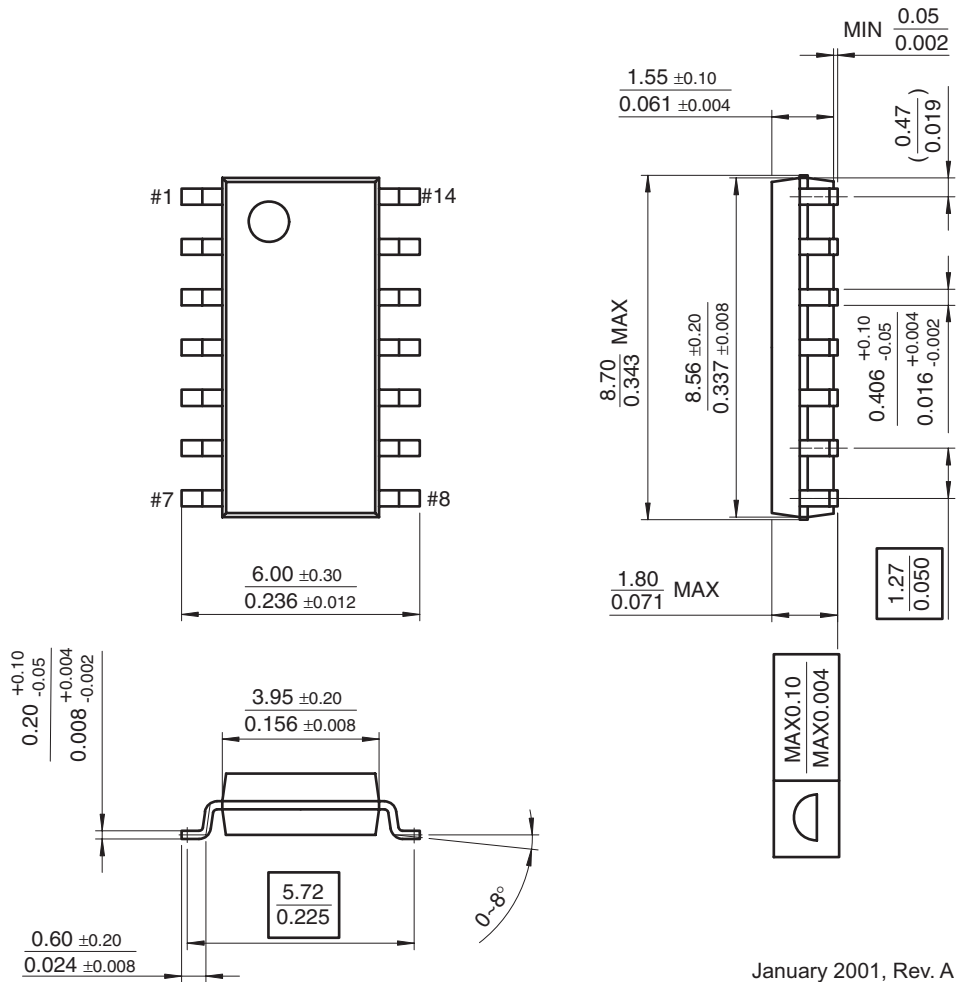

January 2001, Rev. A
14sop225b_dim.pdf

Figure 38. 14-Lead Small Outline Package



TRADEMARKS

The following are registered and unregistered trademarks Fairchild Semiconductor owns or is authorized to use and is not intended to be an exhaustive list of all such trademarks.

ACEx [®]	HiSeC [™]	PowerTrench [®]	TinyLogic [®]
Across the board. Around the world. [™]	<i>i-Lo</i> [™]	Programmable Active Droop [™]	TINYOPTO [™]
ActiveArray [™]	ImpliedDisconnect [™]	QFET [®]	TinyPower [™]
Bottomless [™]	IntelliMAX [™]	QS [™]	TinyWire [™]
Build it Now [™]	ISOPLANAR [™]	QT Optoelectronics [™]	TruTranslation [™]
CoolFET [™]	MICROCOUPLER [™]	Quiet Series [™]	μSerDes [™]
CROSSVOLT [™]	MicroPak [™]	RapidConfigure [™]	UHC [®]
CTL [™]	MICROWIRE [™]	RapidConnect [™]	UniFET [™]
Current Transfer Logic [™]	MSX [™]	ScalarPump [™]	VCX [™]
DOME [™]	MSXPro [™]	SMART START [™]	Wire [™]
E ² C MOS [™]	OCX [™]	SPM [®]	
EcoSPARK [®]	OCXPro [™]	SuperFET [™]	
EnSigna [™]	OPTOLOGIC [®]	SuperSOT [™] -3	
FACT Quiet Series [™]	OPTOPLANAR [®]	SuperSOT [™] -6	
FACT [®]	PACMAN [™]	SuperSOT [™] -8	
FAST [®]	POP [™]	TCM [™]	
FASTr [™]	Power220 [®]	The Power Franchise [®]	
FPS [™]	Power247 [®]	 ™	
FRFET [®]	PowerEdge [™]	TinyBoost [™]	
GlobalOptoisolator [™]	PowerSaver [™]	TinyBuck [™]	
GTO [™]			

DISCLAIMER

FAIRCHILD SEMICONDUCTOR RESERVES THE RIGHT TO MAKE CHANGES WITHOUT FURTHER NOTICE TO ANY PRODUCTS HEREIN TO IMPROVE RELIABILITY, FUNCTION OR DESIGN. FAIRCHILD DOES NOT ASSUME ANY LIABILITY ARISING OUT OF THE APPLICATION OR USE OF ANY PRODUCT OR CIRCUIT DESCRIBED HEREIN; NEITHER DOES IT CONVEY ANY LICENSE UNDER ITS PATENT RIGHTS, NOR THE RIGHTS OF OTHERS. THESE SPECIFICATIONS DO NOT EXPAND THE TERMS OF FAIRCHILD'S WORLDWIDE TERMS AND CONDITIONS, SPECIFICALLY THE WARRANTY THEREIN, WHICH COVERS THESE PRODUCTS.

LIFE SUPPORT POLICY

FAIRCHILD'S PRODUCTS ARE NOT AUTHORIZED FOR USE AS CRITICAL COMPONENTS IN LIFE SUPPORT DEVICES OR SYSTEMS WITHOUT THE EXPRESS WRITTEN APPROVAL OF FAIRCHILD SEMICONDUCTOR CORPORATION.

As used herein:

- Life support devices or systems are devices or systems which, (a) are intended for surgical implant into the body or (b) support or sustain life, and (c) whose failure to perform when properly used in accordance with instructions for use provided in the labeling, can be reasonably expected to result in a significant injury of the user.
- A critical component in any component of a life support, device, or system whose failure to perform can be reasonably expected to cause the failure of the life support device or system, or to affect its safety or effectiveness.

PRODUCT STATUS DEFINITIONS

Definition of Terms

Datasheet Identification	Product Status	Definition
Advance Information	Formative or In Design	This datasheet contains the design specifications for product development. Specifications may change in any manner without notice.
Preliminary	First Production	This datasheet contains preliminary data; supplementary data will be published at a later date. Fairchild Semiconductor reserves the right to make changes at any time without notice to improve design.
No Identification Needed	Full Production	This datasheet contains final specifications. Fairchild Semiconductor reserves the right to make changes at any time without notice to improve design.
Obsolete	Not In Production	This datasheet contains specifications on a product that has been discontinued by Fairchild Semiconductor. The datasheet is printed for reference information only.