

## Dual P-Channel 2.5-V (G-S) MOSFET

PRODUCT SUMMARY		
$V_{DS}$ (V)	$r_{DS(on)}$ ( $\Omega$ )	$I_D$ (A)
-20	0.155 @ $V_{GS} = -4.5$ V	$\pm 2.9$
	0.180 @ $V_{GS} = -3.6$ V	$\pm 2.7$
	0.260 @ $V_{GS} = -2.5$ V	$\pm 2.2$

**TrenchFET<sup>®</sup>**  
Power MOSFETS  
2.5-V Rated

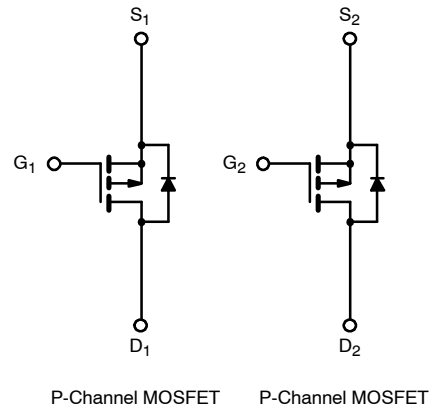
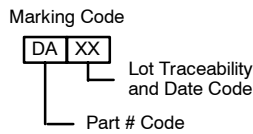
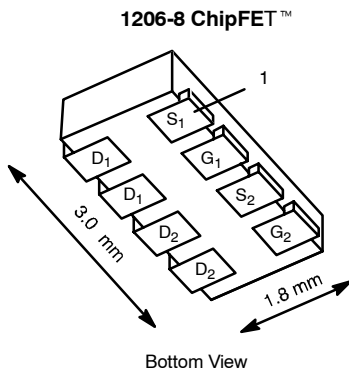

Ordering Information: Si5903DC-T1

ABSOLUTE MAXIMUM RATINGS ( $T_A = 25^\circ\text{C}$ UNLESS OTHERWISE NOTED)					
Parameter	Symbol	5 secs	Steady State	Unit	
Drain-Source Voltage	$V_{DS}$	-20		V	
Gate-Source Voltage	$V_{GS}$	$\pm 12$			
Continuous Drain Current ( $T_J = 150^\circ\text{C}$ ) <sup>a</sup>	$I_D$	$T_A = 25^\circ\text{C}$	$\pm 2.9$	$\pm 2.1$	A
		$T_A = 85^\circ\text{C}$	$\pm 2.1$	$\pm 1.5$	
Pulsed Drain Current	$I_{DM}$	$\pm 10$			
Continuous Source Current (Diode Conduction) <sup>a</sup>	$I_S$	-1.8	-0.9		
Maximum Power Dissipation <sup>a</sup>	$P_D$	$T_A = 25^\circ\text{C}$	2.1	1.1	W
		$T_A = 85^\circ\text{C}$	1.1	0.6	
Operating Junction and Storage Temperature Range	$T_J, T_{stg}$	-55 to 150		$^\circ\text{C}$	
Soldering Recommendations (Peak Temperature) <sup>b, c</sup>		260			

THERMAL RESISTANCE RATINGS					
Parameter		Symbol	Typical	Maximum	Unit
Maximum Junction-to-Ambient <sup>a</sup>	$t \leq 5$ sec	$R_{thJA}$	50	60	$^\circ\text{C/W}$
	Steady State		90	110	
Maximum Junction-to-Foot (Drain)	Steady State	$R_{thJF}$	30	40	

**Notes**

- Surface Mounted on 1" x 1" FR4 Board.
- See Reliability Manual for profile. The ChipFET is a leadless package. The end of the lead terminal is exposed copper (not plated) as a result of the singulation process in manufacturing. A solder fillet at the exposed copper tip cannot be guaranteed and is not required to ensure adequate bottom side solder interconnection.
- Rework Conditions: manual soldering with a soldering iron is not recommended for leadless components.



SPECIFICATIONS (T <sub>J</sub> = 25 °C UNLESS OTHERWISE NOTED)						
Parameter	Symbol	Test Condition	Min	Typ	Max	Unit
<b>Static</b>						
Gate Threshold Voltage	V <sub>GS(th)</sub>	V <sub>DS</sub> = V <sub>GS</sub> , I <sub>D</sub> = -250 μA	-0.6			V
Gate-Body Leakage	I <sub>GSS</sub>	V <sub>DS</sub> = 0 V, V <sub>GS</sub> = ±12 V			±100	nA
Zero Gate Voltage Drain Current	I <sub>DSS</sub>	V <sub>DS</sub> = -16 V, V <sub>GS</sub> = 0 V			-1	μA
		V <sub>DS</sub> = -16 V, V <sub>GS</sub> = 0 V, T <sub>J</sub> = 85 °C			-5	
On-State Drain Current <sup>a</sup>	I <sub>D(on)</sub>	V <sub>DS</sub> ≤ -5 V, V <sub>GS</sub> = -4.5 V	-10			A
Drain-Source On-State Resistance <sup>a</sup>	r <sub>DS(on)</sub>	V <sub>GS</sub> = -4.5 V, I <sub>D</sub> = -2.1 A		0.130	0.155	Ω
		V <sub>GS</sub> = -3.6 V, I <sub>D</sub> = -2.0 A		0.150	0.180	
		V <sub>GS</sub> = -2.5 V, I <sub>D</sub> = -1.7 A		0.215	0.260	
Forward Transconductance <sup>a</sup>	g <sub>fs</sub>	V <sub>DS</sub> = -10 V, I <sub>D</sub> = -2.1 A		5		S
Diode Forward Voltage <sup>a</sup>	V <sub>SD</sub>	I <sub>S</sub> = -0.9 A, V <sub>GS</sub> = 0 V		-0.8	-1.2	V
<b>Dynamic<sup>b</sup></b>						
Total Gate Charge	Q <sub>g</sub>	V <sub>DS</sub> = -10 V, V <sub>GS</sub> = -4.5 V, I <sub>D</sub> = -2.1 A		3	6	nC
Gate-Source Charge	Q <sub>gs</sub>			0.9		
Gate-Drain Charge	Q <sub>gd</sub>			0.6		
Turn-On Delay Time	t <sub>d(on)</sub>	V <sub>DD</sub> = -10 V, R <sub>L</sub> = 10 Ω I <sub>D</sub> ≅ -1 A, V <sub>GEN</sub> = -4.5 V, R <sub>G</sub> = 6 Ω		13	20	ns
Rise Time	t <sub>r</sub>			35	55	
Turn-Off Delay Time	t <sub>d(off)</sub>			25	40	
Fall Time	t <sub>f</sub>			25	40	
Source-Drain Reverse Recovery Time	t <sub>rr</sub>		I <sub>F</sub> = -0.9 A, di/dt = 100 A/μs		40	

Notes

- a. Pulse test; pulse width ≤ 300 μs, duty cycle ≤ 2%.
- b. Guaranteed by design, not subject to production testing.

**TYPICAL CHARACTERISTICS (25 °C UNLESS NOTED)**

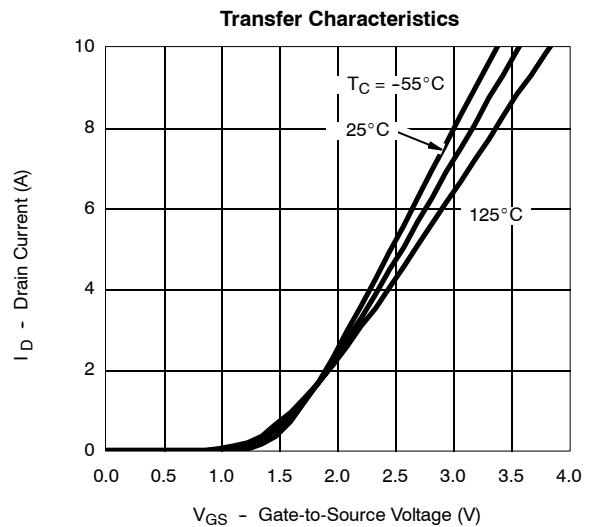
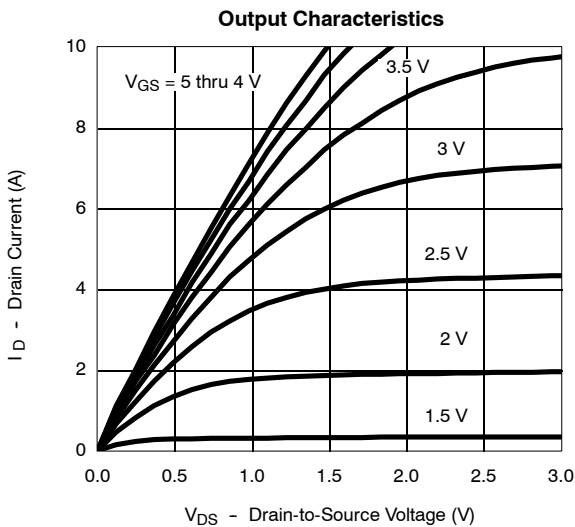

**TYPICAL CHARACTERISTICS (25°C UNLESS NOTED)**

**On-Resistance vs. Drain Current**

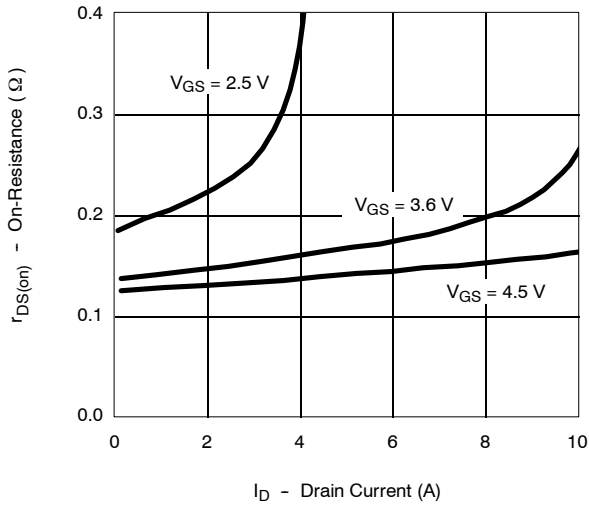

**Capacitance**

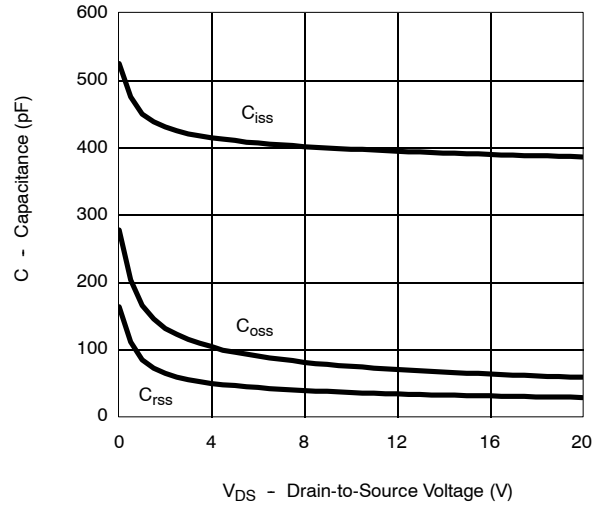

**Gate Charge**

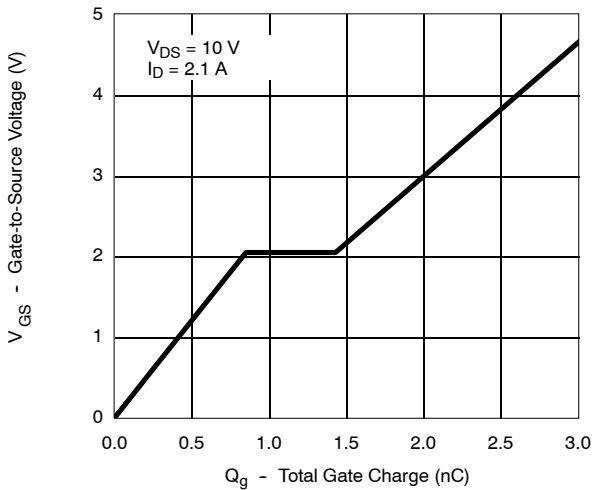

**On-Resistance vs. Junction Temperature**

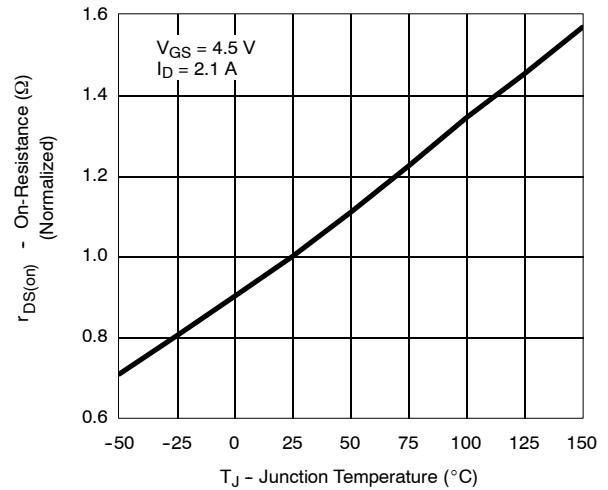

**Source-Drain Diode Forward Voltage**

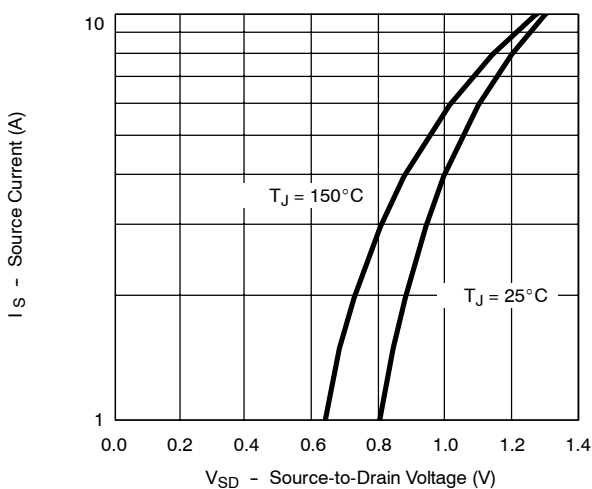

**On-Resistance vs. Gate-to-Source Voltage**

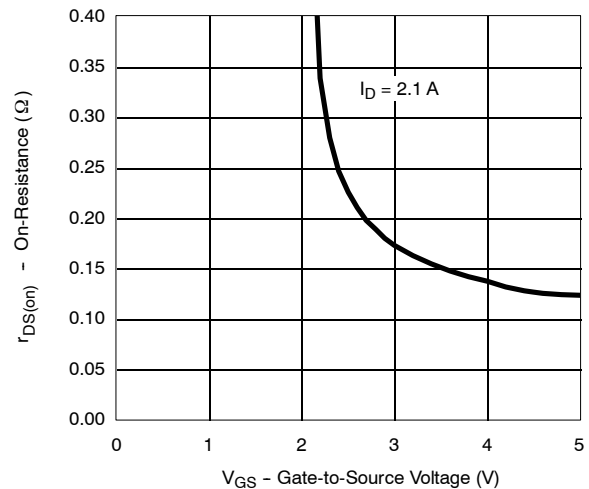

**TYPICAL CHARACTERISTICS (25 °C UNLESS NOTED)**

