

P-Channel 1.8-V (G-S) MOSFET With Schottky Diode

MOSFET PRODUCT SUMMARY		
V _{DS} (V)	r _{DS(on)} (Ω)	I _D (A)
-20	0.110 @ V _{GS} = -4.5 V	-3.6
	0.160 @ V _{GS} = -2.5 V	-3.0
	0.240 @ V _{GS} = -1.8 V	-2.4

SCHOTTKY PRODUCT SUMMARY		
V _{KA} (V)	V _f (V) Diode Forward Voltage	I _F (A)
20	0.375 V @ 1 A	1.0

FEATURES

- TrenchFET® Power MOSFETS
- Ultra Low V_f Schottky
- Si5853DC Pin Compatible

APPLICATIONS

- Charging Circuit in Portable Devices

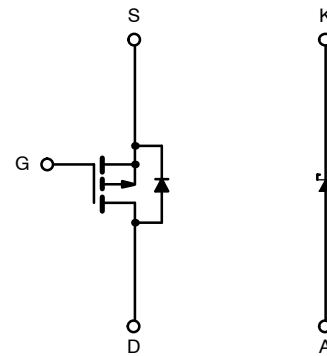
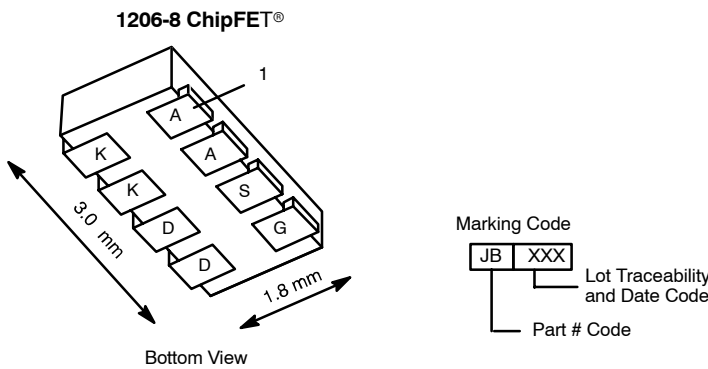

P-Channel MOSFET

Ordering Information: Si5855DC-T1

ABSOLUTE MAXIMUM RATINGS (T _A = 25°C UNLESS OTHERWISE NOTED)					
Parameter	Symbol	5 sec	Steady State	Unit	
Drain-Source Voltage (MOSFET)	V _{DS}	-20		V	
Reverse Voltage (Schottky)	V _{KA}	20			
Gate-Source Voltage (MOSFET)	V _{GS}	±8			
Continuous Drain Current (T _J = 150°C) (MOSFET) ^a	I _D	T _A = 25°C	-3.6	-2.7	A
		T _A = 85°C	-2.6	-1.9	
Pulsed Drain Current (MOSFET)	I _{DM}	-10			
Continuous Source Current (MOSFET Diode Conduction) ^a	I _S	-1.8	-0.9		
Average Forward Current (Schottky)	I _F	1.0			
Pulsed Forward Current (Schottky)	I _{FM}	7			
Maximum Power Dissipation (MOSFET) ^a	P _D	T _A = 25°C	2.1	1.1	W
		T _A = 85°C	1.1	0.6	
Maximum Power Dissipation (Schottky) ^a	P _D	T _A = 25°C	1.9	1.1	
		T _A = 85°C	1.0	0.56	
Operating Junction and Storage Temperature Range	T _J , T _{stg}	-55 to 150		°C	
Soldering Recommendations (Peak Temperature) ^{b, c}		260			

Notes

- Surface Mounted on 1" x 1" FR4 Board.
- See Reliability Manual for profile. The ChipFET is a leadless package. The end of the lead terminal is exposed copper (not plated) as a result of the singulation process in manufacturing. A solder fillet at the exposed copper tip cannot be guaranteed and is not required to ensure adequate bottom side solder interconnection.
- Rework Conditions: manual soldering with a soldering iron is not recommended for leadless components.

THERMAL RESISTANCE RATINGS						
Parameter		Device	Symbol	Typical	Maximum	Unit
Junction-to-Ambient ^a	t ≤ 5 sec	MOSFET	R _{thJA}	50	60	°C/W
		Schottky		54	65	
	Steady State	MOSFET		90	110	
		Schottky		95	115	
Junction-to-Foot	Steady State	MOSFET	R _{thJF}	30	40	
		Schottky	30	40		

Notes

a. Surface Mounted on 1" x 1" FR4 Board.

MOSFET SPECIFICATIONS (T _J = 25°C UNLESS OTHERWISE NOTED)						
Parameter	Symbol	Test Condition	Min	Typ	Max	Unit
Static						
Gate Threshold Voltage	V _{GS(th)}	V _{DS} = V _{GS} , I _D = -250 μA	-0.45		-1.0	V
Gate-Body Leakage	I _{GSS}	V _{DS} = 0 V, V _{GS} = ±8 V			±100	nA
Zero Gate Voltage Drain Current	I _{DSS}	V _{DS} = -16 V, V _{GS} = 0 V			-1	μA
		V _{DS} = -16 V, V _{GS} = 0 V, T _J = 85°C			-5	
On-State Drain Current ^a	I _{D(on)}	V _{DS} ≤ -5 V, V _{GS} = -4.5 V	-10			A
Drain-Source On-State Resistance ^a	r _{DS(on)}	V _{GS} = -4.5 V, I _D = -2.7 A		0.095	0.110	Ω
		V _{GS} = -2.5 V, I _D = -2.2 A		0.137	0.160	
		V _{GS} = -1.8 V, I _D = -1 A		0.205	0.240	
Forward Transconductance ^a	g _{fs}	V _{DS} = -10 V, I _D = -2.7 A		7		S
Diode Forward Voltage ^a	V _{SD}	I _S = -0.9 A, V _{GS} = 0 V		-0.8	-1.2	V
Dynamic^b						
Total Gate Charge	Q _g	V _{DS} = -10 V, V _{GS} = -4.5 V, I _D = -2.7 A		4.4	6.5	nC
Gate-Source Charge	Q _{gs}		1.4			
Gate-Drain Charge	Q _{gd}		0.65			
Turn-On Delay Time	t _{d(on)}	V _{DD} = -10 V, R _L = 10 Ω I _D ≅ -1 A, V _{GEN} = -4.5 V, R _G = 6 Ω		16	25	ns
Rise Time	t _r		30	45		
Turn-Off Delay Time	t _{d(off)}		30	45		
Fall Time	t _f		27	40		
Source-Drain Reverse Recovery Time	t _{rr}	I _F = -0.9 A, di/dt = 100 A/μs		20	40	

Notes

a. Pulse test; pulse width ≤ 300 μs, duty cycle ≤ 2%.

b. Guaranteed by design, not subject to production testing.

SCHOTTKY SPECIFICATIONS (T _J = 25°C UNLESS OTHERWISE NOTED)						
Parameter	Symbol	Test Condition	Min	Typ	Max	Unit
Forward Voltage Drop	V _F	I _F = 1 A		0.34	0.375	V
		I _F = 1 A, T _J = 125°C		0.255	0.290	
Maximum Reverse Leakage Current	I _{rm}	V _r = 20 V		0.05	0.500	mA
		V _r = 20 V, T _J = 85°C		2	20	
		V _r = 20 V, T _J = 125°C		10	100	
Junction Capacitance	C _T	V _r = 10 V		90		pF

TYPICAL CHARACTERISTICS (25°C UNLESS NOTED)

MOSFET

Output Characteristics

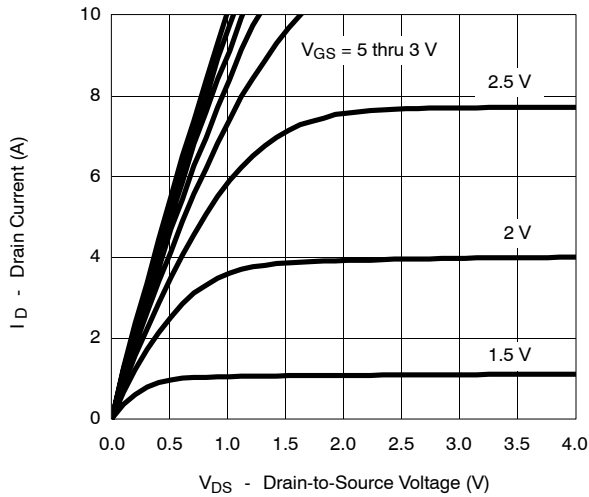

Transfer Characteristics

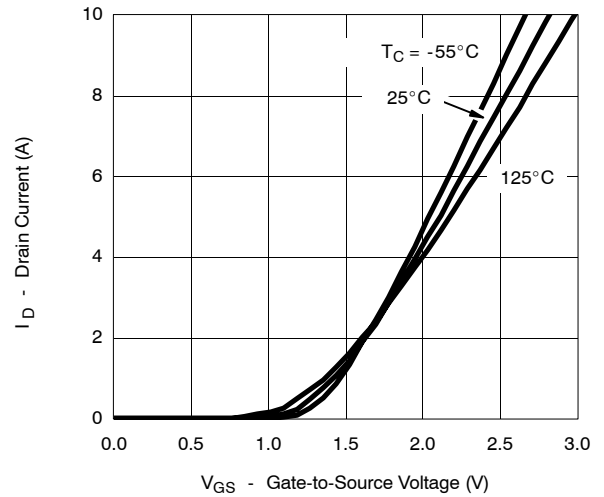

On-Resistance vs. Drain Current

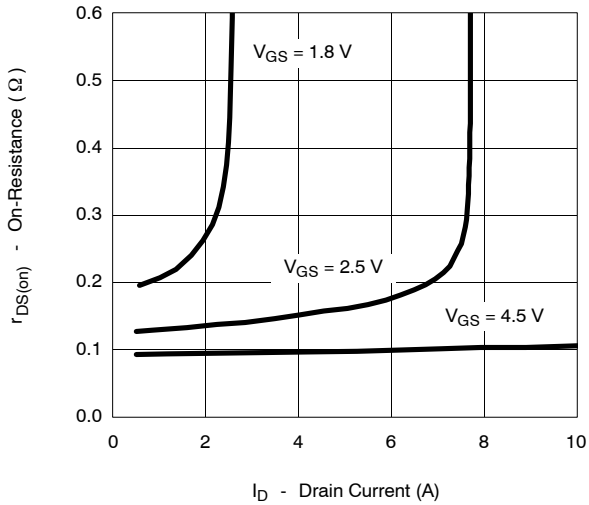

Capacitance

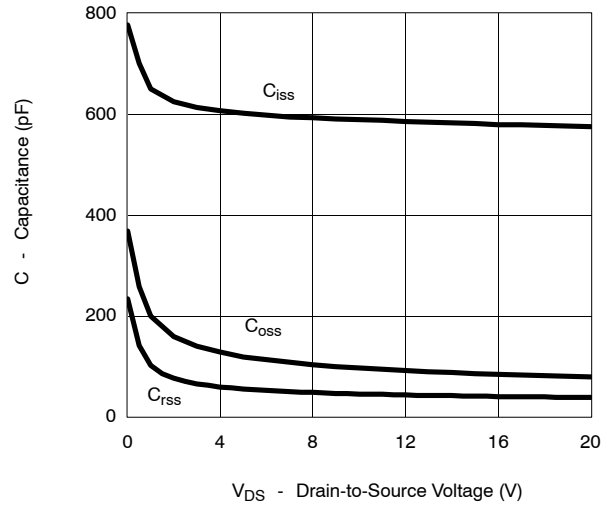

Gate Charge

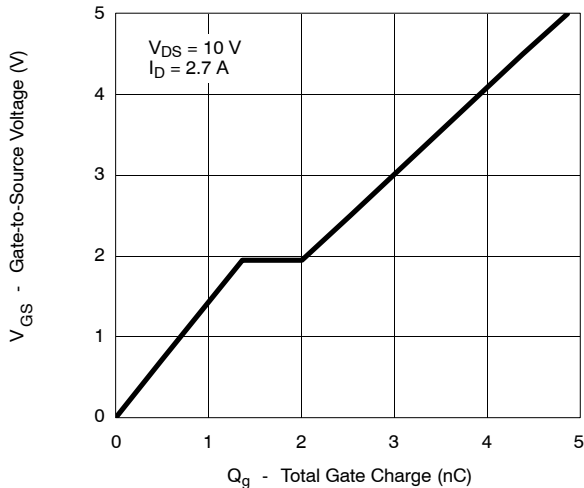

On-Resistance vs. Junction Temperature

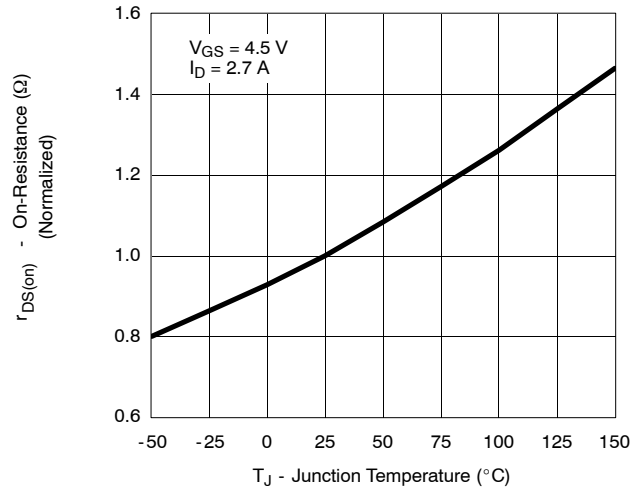



TYPICAL CHARACTERISTICS (25 °C UNLESS NOTED)

MOSFET

Source-Drain Diode Forward Voltage

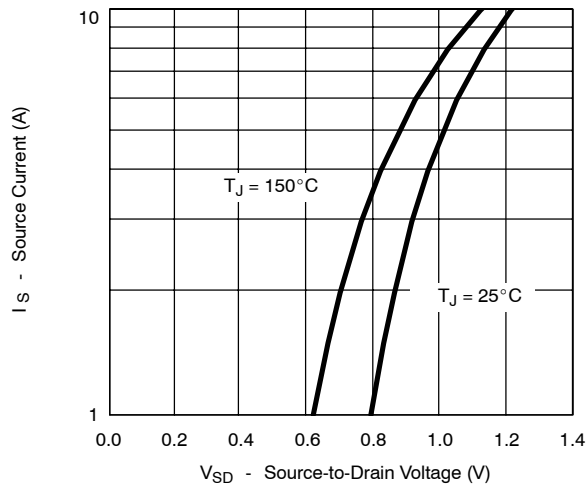

On-Resistance vs. Gate-to-Source Voltage

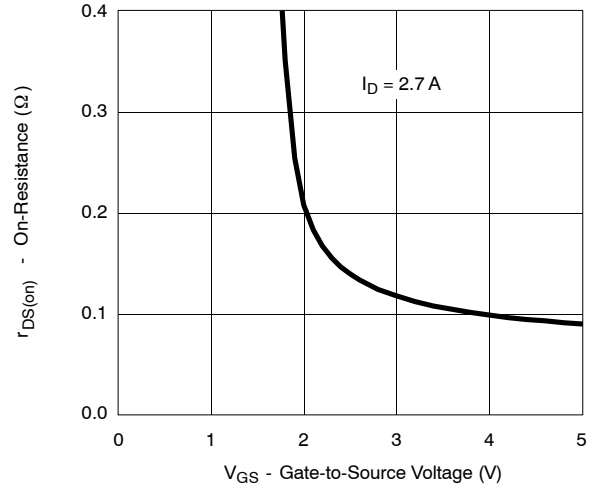

Threshold Voltage

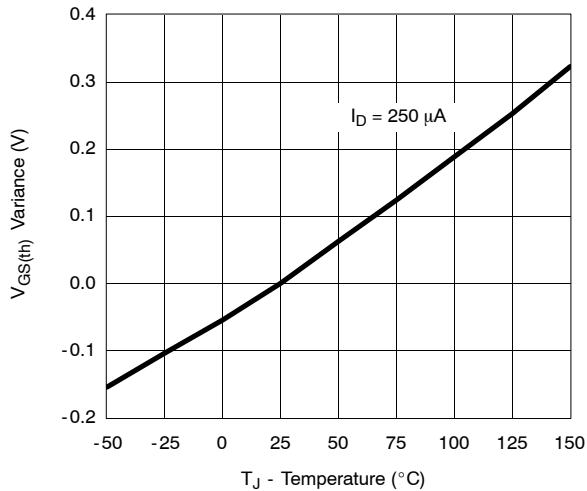

Single Pulse Power

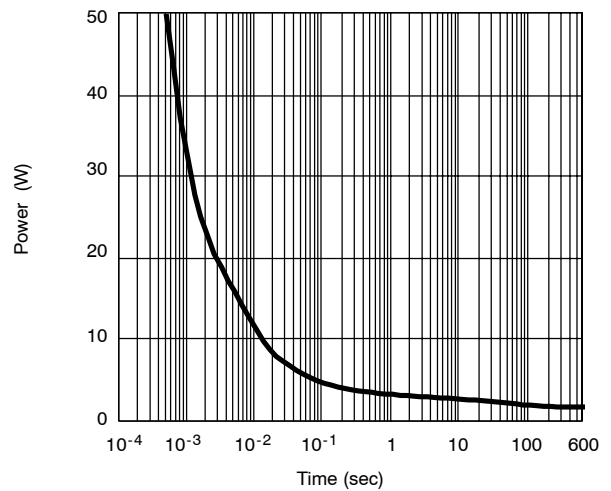

Safe Operating Area

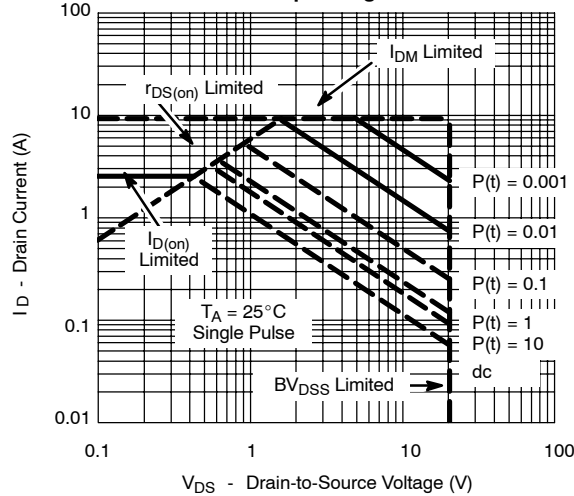

TYPICAL CHARACTERISTICS (25°C UNLESS NOTED)

MOSFET

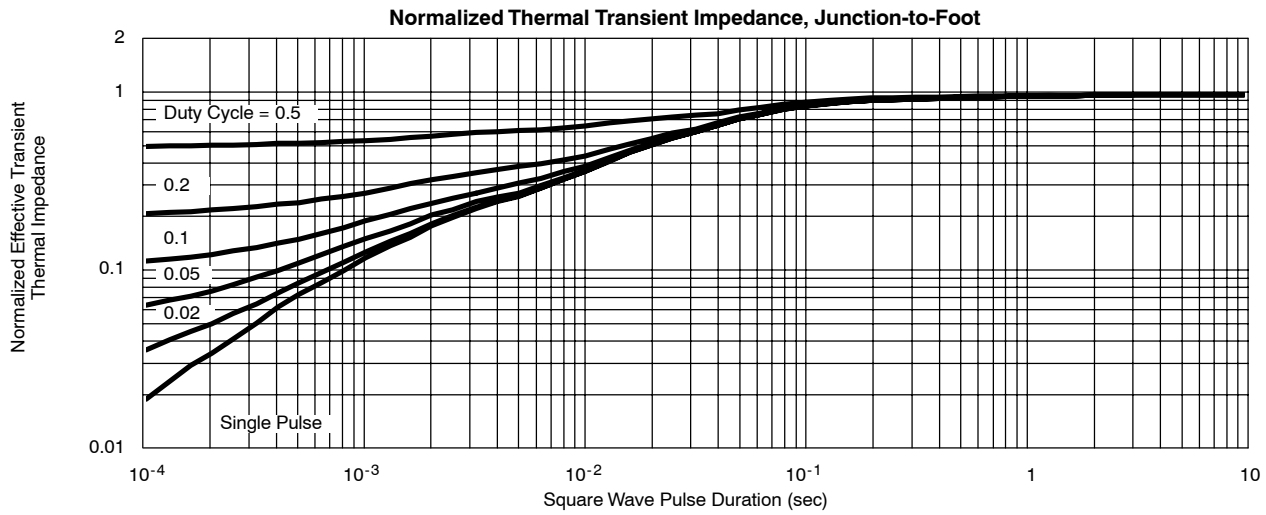
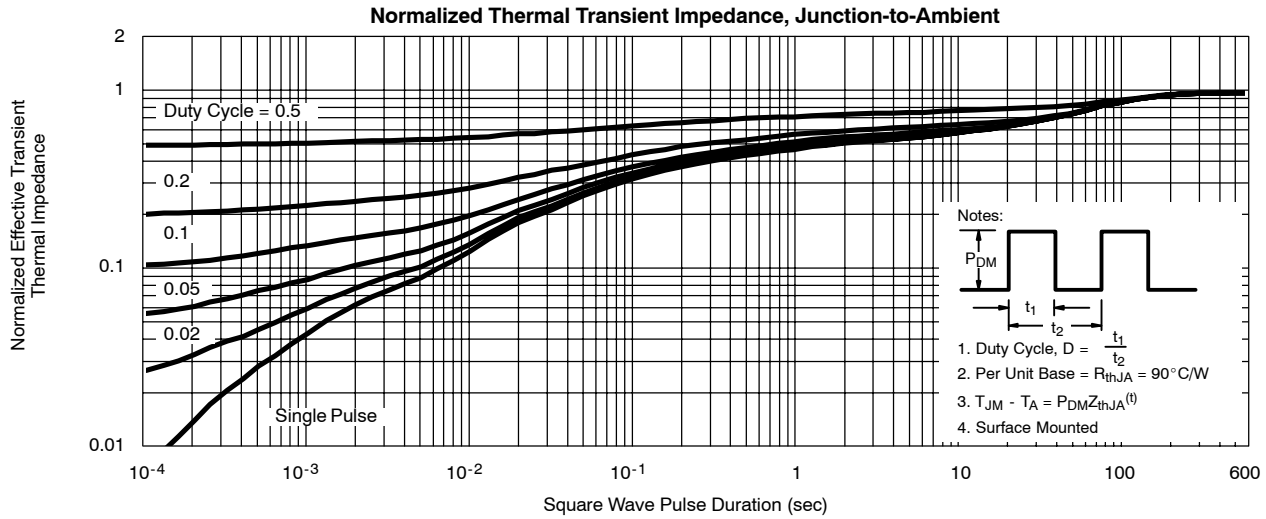

TYPICAL CHARACTERISTICS (25°C UNLESS NOTED)

SCHOTTKY

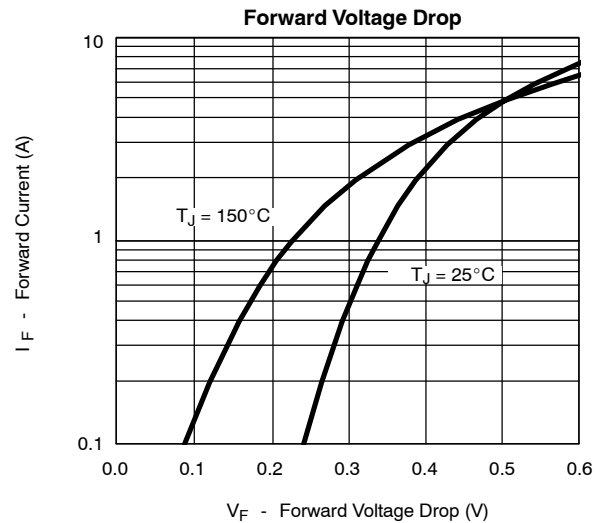
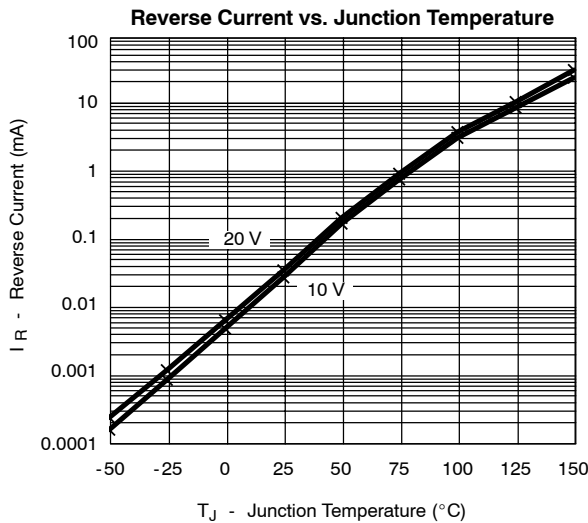



TYPICAL CHARACTERISTICS (25 °C UNLESS NOTED)

SCHOTTKY

