

(TLP504A)
 PROGRAMMABLE CONTROLLERS

AC / DC-INPUT MODULE

SOLID STATE RELAY

The TOSHIBA TLP504A and TLP504A-2 consists of a photo-transistor optically coupled to a gallium arsenide infrared emitting diode.

The TLP504A offers two isolated channels in a eight lead plastic DIP package, while the TLP504A-2 provides four isolated channels in a sixteen plastic DIP package.

- Collector-Emitter Voltage : 55V (Min.)
- Current Transfer Ratio : 50% (Min.)
 Rank GB : 100% (Min.)
- Isolation Voltage : 2500Vrms (Min.)
- UL Recognized : UL1577,
 File No. E67349

PIN CONFIGURATIONS (TOP VIEW)

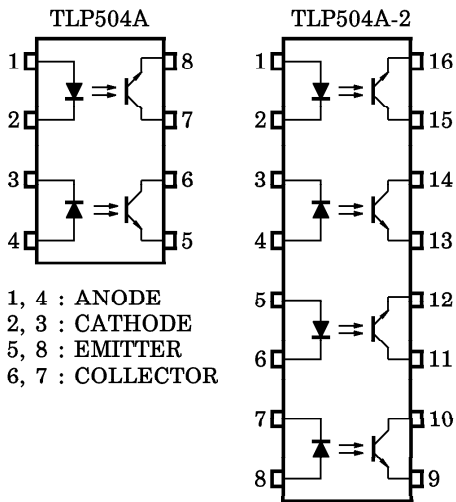

1, 4 : ANODE
 2, 3 : CATHODE
 5, 8 : EMITTER
 6, 7 : COLLECTOR

1, 4, 5, 8 : ANODE
 2, 3, 6, 7 : CATHODE
 9, 12, 13, 16 : EMITTER
 10, 11, 14, 15 : COLLECTOR

Unit in mm

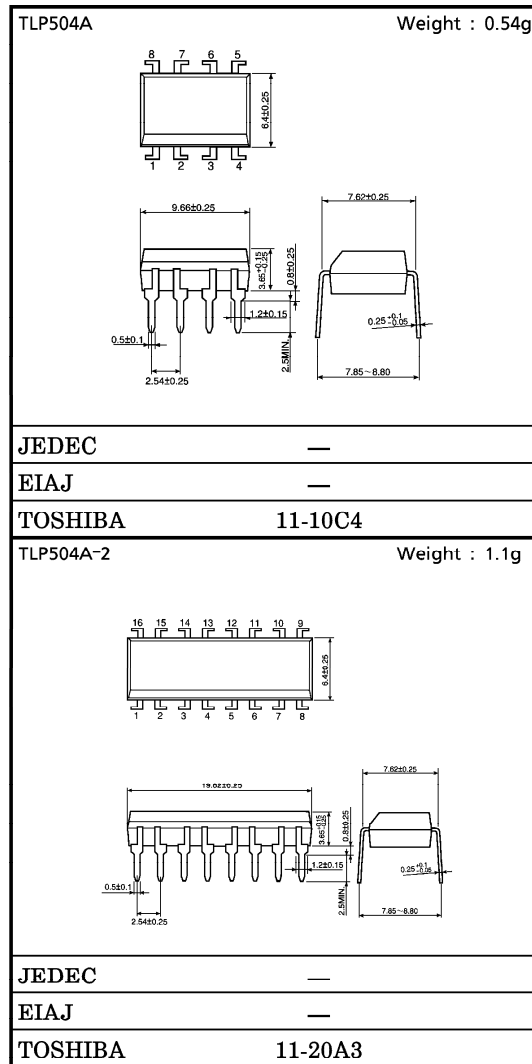

© The information contained herein is presented only as a guide for the applications of our products. No responsibility is assumed by TOSHIBA CORPORATION for any infringements of intellectual property or other rights of the third parties which may result from its use. No license is granted by implication or otherwise under any intellectual property or other rights of TOSHIBA CORPORATION or others.

© These TOSHIBA products are intended for use in general commercial applications (office equipment, communication equipment, measuring equipment, domestic appliances, etc.), please make sure that you consult with us before you use these TOSHIBA products in equipment which requires extraordinarily high quality and/or reliability, and in equipment which may involve life threatening or critical application, including but not limited to such uses as atomic energy control, airplane or spaceship instrumentation, traffic signals, medical instrumentation, combustion control, all types of safety devices, etc. TOSHIBA cannot accept and hereby disclaims liability for any damage which may occur in case the TOSHIBA products are used in such equipment or applications without prior consultation with TOSHIBA.



TLP504A - 1

1996 - 4 - 8

TOSHIBA CORPORATION

(TLP504A)

MAXIMUM RATINGS (Ta = 25°C)

CHARACTERISTIC	SYMBOL	RATING		UNIT	
		TLP504A	TLP504A-2		
LED	Forward Current	I _F	60	50	mA
	Forward Current Derating	ΔI _F / °C	-0.7 (Ta ≥ 39°C)	-0.5 (Ta ≥ 25°C)	mA / °C
	Pulse Forward Current	I _{FP}	1 (100μs pulse, 100pps)		A
	Reverse Voltage	V _R	5		V
	Junction Temperature	T _j	125		°C
DETECTOR	Collector-Emitter Voltage	V _{CEO}	55		V
	Emitter-Collector Voltage	V _{ECO}	7		V
	Collector Current	I _C	50		mA
	Collector Power Dissipation (1 Circuit)	P _C	150	100	mW
	Collector Power Dissipation Derating (1 Circuit Ta ≥ 25°C)	ΔP _C / °C	-1.5	-1.0	mW / °C
	Junction Temperature	T _j	125		°C
Storage Temperature Range	T _{stg}	-55~150		°C	
Operating Temperature Range	T _{opr}	-55~100		°C	
Lead Soldering Temperature	T _{sol}	260 (10s)		°C	
Total Package Power Dissipation	R _T	250	150	mW	
Total Package Power Dissipation Derating (Ta ≥ 25°C)	ΔP _T / °C	-2.5	-1.5	mW / °C	
Isolation Voltage	BV _S	2500 (AC, 1min., R.H. ≤ 60%) (Note 1)		V _{rms}	

Note 1 : Device considered a two terminal device : LED side pins shorted together and DETECTOR side pins shorted together.

TLP504A - 2
1996 - 4 - 8
TOSHIBA CORPORATION

(TLP504A)

INDIVIDUAL ELECTRICAL CHARACTERISTICS (Ta = 25°C)

CHARACTERISTIC		SYMBOL	TEST CONDITION	MIN.	TYP.	MAX.	UNIT
LED	Forward Voltage	V_F	$I_F = 10\text{mA}$	1.0	1.15	1.3	V
	Reverse Current	I_R	$V_R = 5\text{V}$	—	—	10	μA
	Capacitance	C_T	$V = 0, f = 1\text{MHz}$	—	30	—	pF
DETECTOR	Collector-Emitter Breakdown Voltage	$V_{(BR)CEO}$	$I_C = 0.5\text{mA}$	55	—	—	V
	Emitter-Collector Breakdown Voltage	$V_{(BR)ECO}$	$I_E = 0.1\text{mA}$	7	—	—	V
	Collector Dark Current	I_{CEO}	$V_{CE} = 24\text{V}$	—	10	100	nA
			$V_{CE} = 24\text{V}, T_a = 85^\circ\text{C}$	—	2	50	μA
Capacitance Collector to Emitter	C_{CE}	$V = 0, f = 1\text{MHz}$	—	10	—	pF	

COUPLED ELECTRICAL CHARACTERISTICS (Ta = 25°C)

CHARACTERISTIC	SYMBOL	TEST CONDITION	MIN.	TYP.	MAX.	UNIT
Current Transfer Ratio	I_C / I_F	$I_F = 5\text{mA}, V_{CE} = 5\text{V}$ Rank GB	50	—	600	%
			100	—	600	
Saturated CTR	$I_C / I_F(\text{sat})$	$I_F = 1\text{mA}, V_{CE} = 0.4\text{V}$ Rank GB	—	60	—	%
			30	—	—	
Collector-Emitter Saturation Voltage	$V_{CE(\text{sat})}$	$I_C = 2.4\text{mA}, I_F = 8\text{mA}$ $I_C = 0.2\text{mA}, I_F = 1\text{mA}$ Rank GB	—	—	0.4	V
			—	0.2	—	
			—	—	0.4	

ISOLATION CHARACTERISTICS (Ta = 25°C)

CHARACTERISTIC	SYMBOL	TEST CONDITION	MIN.	TYP.	MAX.	UNIT
Capacitance Input to Output	C_S	$V_S = 0, f = 1\text{MHz}$	—	0.8	—	pF
Isolation Resistance	R_S	$V_S = 500\text{V}$	5×10^{10}	10^{14}	—	Ω
Isolation Voltage	BV_S	AC, 1 minute	2500	—	—	Vrms
		AC, 1 second, in oil	—	5000	—	
		DC, 1 minute, in oil	—	5000	—	Vdc

TLP504A - 3

1996 - 4 - 8

TOSHIBA CORPORATION

(TLP504A)

SWITCHING CHARACTERISTICS (Ta = 25°C)

CHARACTERISTIC	SYMBOL	TEST CONDITION	MIN.	TYP.	MAX.	UNIT
Rise Time	t_r	$V_{CC} = 10V, I_C = 2mA$ $R_L = 100\Omega$	—	2	—	μS
Fall Time	t_f		—	3	—	
Turn-on Time	t_{on}		—	3	—	
Turn-off Time	t_{off}		—	3	—	
Turn-on Time	t_{ON}	$R_L = 1.9k\Omega$ (Fig.1) $V_{CC} = 5V, I_F = 16mA$	—	2	—	μS
Storage Time	t_s		—	15	—	
Turn-off Time	t_{OFF}		—	25	—	

Fig.1 Switching Time Test Circuit

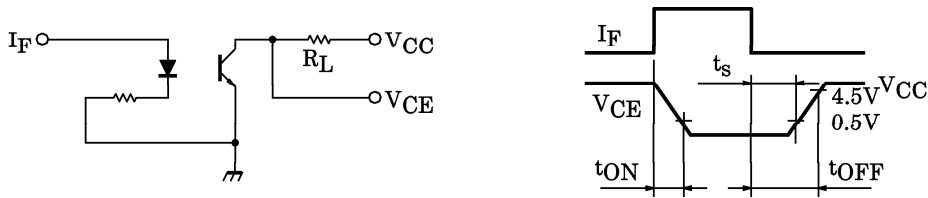

RECOMMENDED OPERATING CONDITIONS

CHARACTERISTIC	SYMBOL	MIN.	TYP.	MAX.	UNIT
Supply Voltage	V_{CC}	—	5	24	V
Forward Current	I_F	—	16	20	mA
Collector Current	I_C	—	1	10	mA
Operating Temperature	T_{opr}	-25	—	85	°C

(TLP504A)

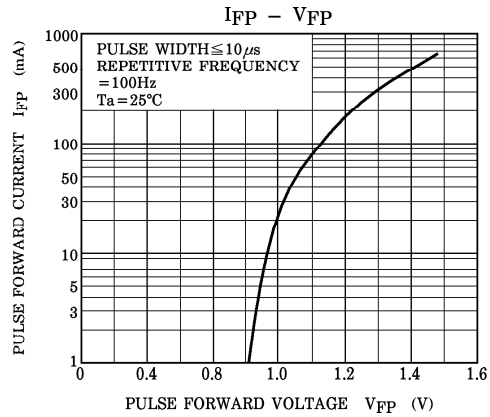
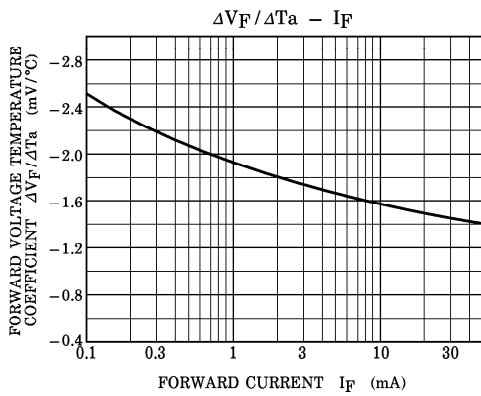
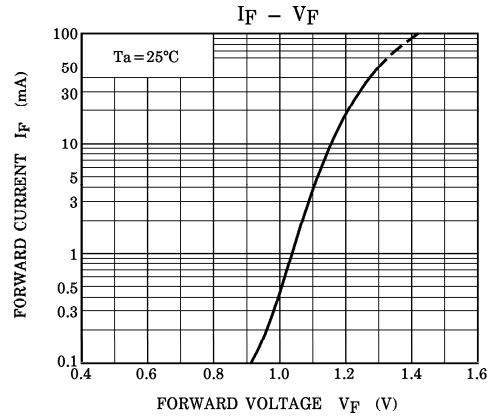
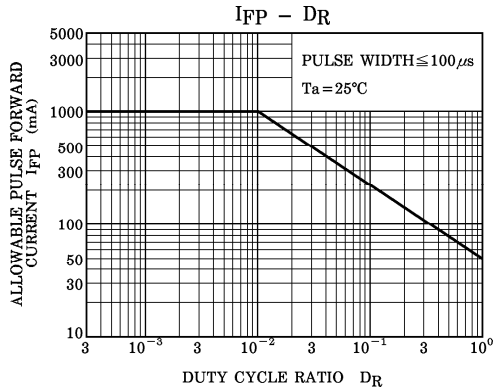
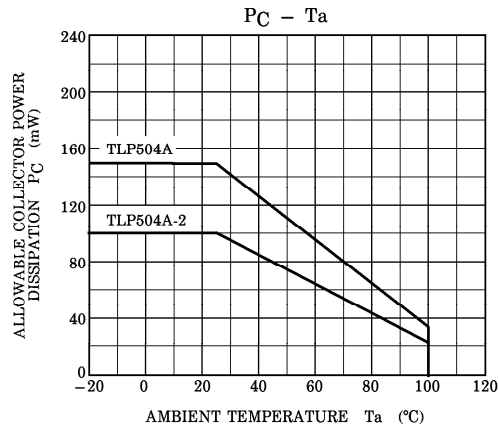
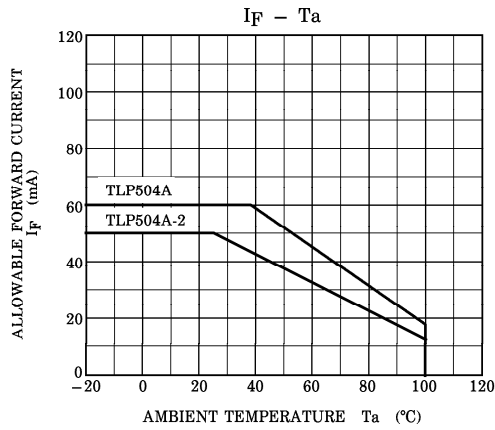

TLP504A - 5
 1996 - 4 - 8
TOSHIBA CORPORATION

(TLP504A)

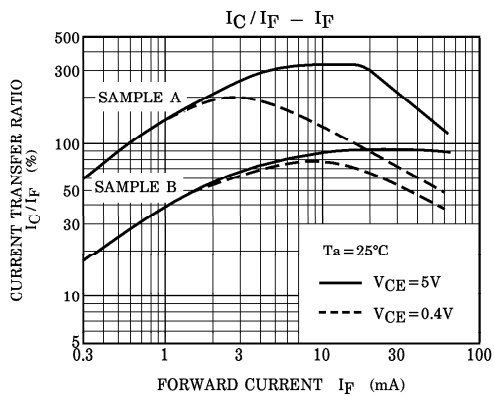
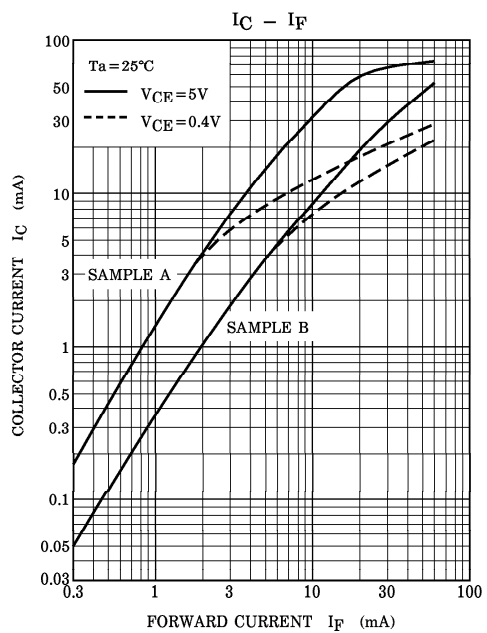
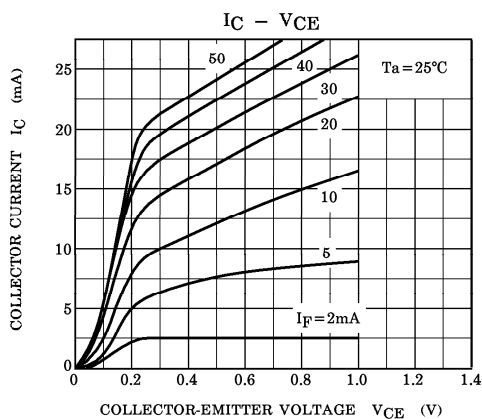
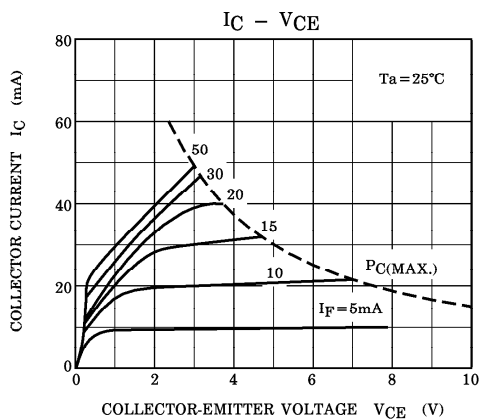
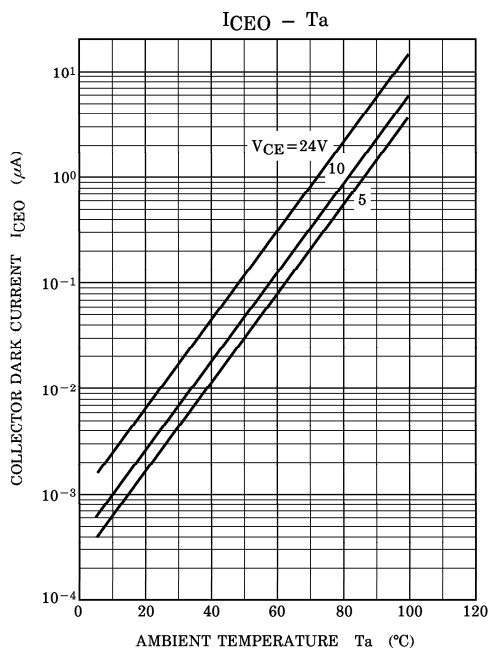

TLP504A - 6
 1996 - 4 - 8
TOSHIBA CORPORATION

(TLP504A)

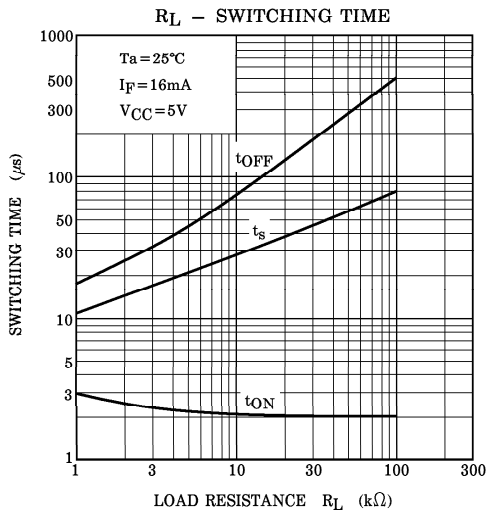
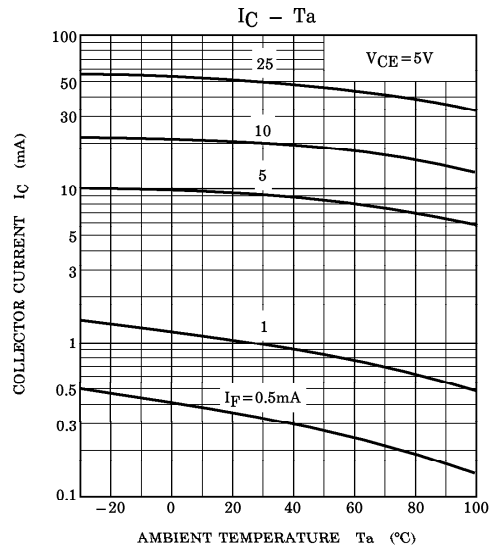
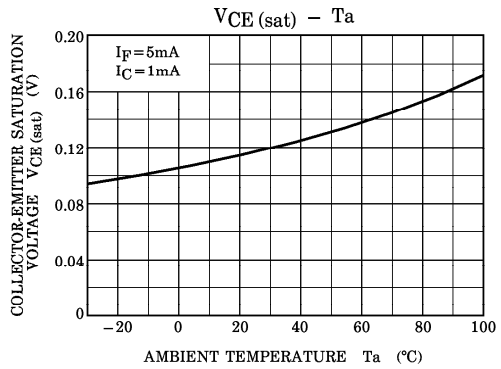

TLP504A - 7*
1996 - 4 - 8
TOSHIBA CORPORATION