

P-Channel 20-V (D-S) MOSFET With Schottky Diode

MOSFET PRODUCT SUMMARY		
V_{DS} (V)	$r_{DS(on)}$ (Ω)	I_D (A)
-20	0.200 @ $V_{GS} = -4.5$ V	± 1.8
	0.340 @ $V_{GS} = -2.5$ V	± 1.3

SCHOTTKY PRODUCT SUMMARY		
V_{KA} (V)	V_f (V) Diode Forward Voltage	I_F (A)
20	0.48 V @ 0.5 A	0.5

LITTLE FOOT Plus™

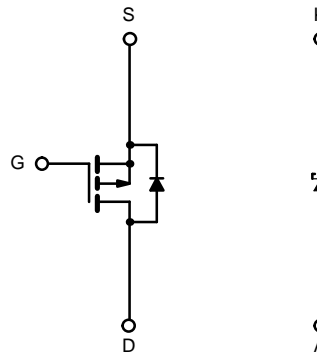
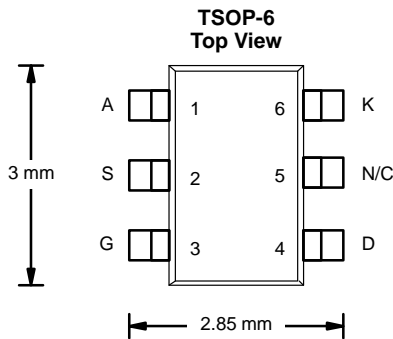

P-Channel MOSFET

ABSOLUTE MAXIMUM RATINGS ($T_A = 25^\circ\text{C}$ UNLESS OTHERWISE NOTED)				
Parameter	Symbol	5 sec	Steady State	Unit
Drain-Source Voltage (MOSFET and Schottky)	V_{DS}	-20		V
Reverse Voltage (Schottky)	V_{KA}	20		
Gate-Source Voltage (MOSFET)	V_{GS}	± 12	± 12	A
Continuous Drain Current ($T_J = 150^\circ\text{C}$) (MOSFET) ^a	$T_A = 25^\circ\text{C}$	± 1.8	± 1.6	
	$T_A = 70^\circ\text{C}$	± 1.5	± 1.2	
Pulsed Drain Current (MOSFET)	I_{DM}	± 7		
Continuous Source Current (MOSFET Diode Conduction) ^a	I_S	-1.05	-0.75	
Average Forward Current (Schottky)	I_F	0.5		
Pulsed Forward Current (Schottky)	I_{FM}	7		W
Maximum Power Dissipation (MOSFET) ^a	$T_A = 25^\circ\text{C}$	1.15	0.83	
	$T_A = 70^\circ\text{C}$	0.73	0.53	
Maximum Power Dissipation (Schottky) ^a	$T_A = 25^\circ\text{C}$	1.0	0.76	
	$T_A = 70^\circ\text{C}$	0.64	0.48	
Operating Junction and Storage Temperature Range	T_J, T_{stg}	-55 to 150		$^\circ\text{C}$

Notes

a. Surface Mounted on 1" x 1" FR4 Board.



THERMAL RESISTANCE RATINGS						
Parameter		Device	Symbol	Typical	Maximum	Unit
Junction-to-Ambient ^a	t ≤ 5 sec	MOSFET	R _{thJA}	93	110	°C/W
		Schottky		103	125	
	Steady State	MOSFET		130	150	
		Schottky		140	165	
Junction-to-Foot	Steady State	MOSFET	R _{thJF}	75	90	
		Schottky	80	95		

Notes

a. Surface Mounted on 1" x 1" FR4 Board.

MOSFET SPECIFICATIONS (T _J = 25°C UNLESS OTHERWISE NOTED)						
Parameter	Symbol	Test Condition	Min	Typ	Max	Unit
Static						
Gate Threshold Voltage	V _{GS(th)}	V _{DS} = V _{GS} , I _D = -250 μA	-0.5			V
Gate-Body Leakage	I _{GSS}	V _{DS} = 0 V, V _{GS} = ±12 V			±100	nA
Zero Gate Voltage Drain Current	I _{DSS}	V _{DS} = -16 V, V _{GS} = 0 V			-1	μA
		V _{DS} = -16 V, V _{GS} = 0 V, T _J = 75°C			-10	
On-State Drain Current ^a	I _{D(on)}	V _{DS} ≥ -5 V, V _{GS} = -4.5 V	-5			A
Drain-Source On-State Resistance ^a	r _{DS(on)}	V _{GS} = -4.5 V, I _D = -1.8 A		0.160	0.200	Ω
		V _{GS} = -2.5 V, I _D = -1.0 A		0.280	0.340	
Forward Transconductance ^a	g _{fs}	V _{DS} = -5 V, I _D = -1.8 A		3.6		S
Diode Forward Voltage ^a	V _{SD}	I _S = -1.05 A, V _{GS} = 0 V		-0.83	-1.10	V
Dynamic^b						
Total Gate Charge	Q _g	V _{DS} = -10 V, V _{GS} = -4.5 V, I _D = -1.8 A		2.7	4.0	nC
Gate-Source Charge	Q _{gs}			0.4		
Gate-Drain Charge	Q _{gd}			0.6		
Turn-On Delay Time	t _{d(on)}	V _{DD} = -10 V, R _L = 10 Ω I _D ≅ -1 A, V _{GEN} = -4.5 V, R _G = 6 Ω		11	17	ns
Rise Time	t _r			34	50	
Turn-Off Delay Time	t _{d(off)}			19	30	
Fall Time	t _f			24	36	
Source-Drain Reverse Recovery Time	t _{rr}	I _F = -1.05 A, di/dt = 100 A/μs		20	40	

Notes

a. Pulse test; pulse width ≤ 300 μs, duty cycle ≤ 2%.

b. Guaranteed by design, not subject to production testing.

SCHOTTKY SPECIFICATIONS (T _J = 25°C UNLESS OTHERWISE NOTED)						
Parameter	Symbol	Test Condition	Min	Typ	Max	Unit
Forward Voltage Drop	V _F	I _F = 0.5 A		0.42	0.48	V
		I _F = 0.5 A, T _J = 125°C		0.33	0.4	
Maximum Reverse Leakage Current	I _{rm}	V _r = 20 V		0.002	0.100	mA
		V _r = 20 V, T _J = 75°C		0.06	1	
		V _r = 20 V, T _J = 125°C		1.5	10	
Junction Capacitance	C _T	V _r = 10 V		31		pF



TYPICAL CHARACTERISTICS (25°C UNLESS NOTED) **MOSFET**

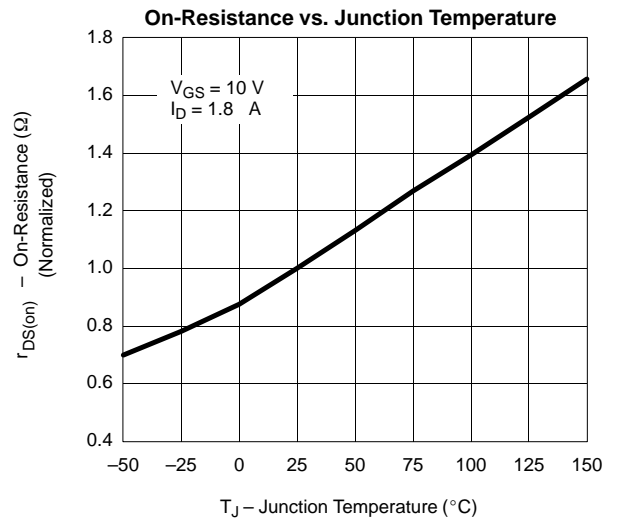
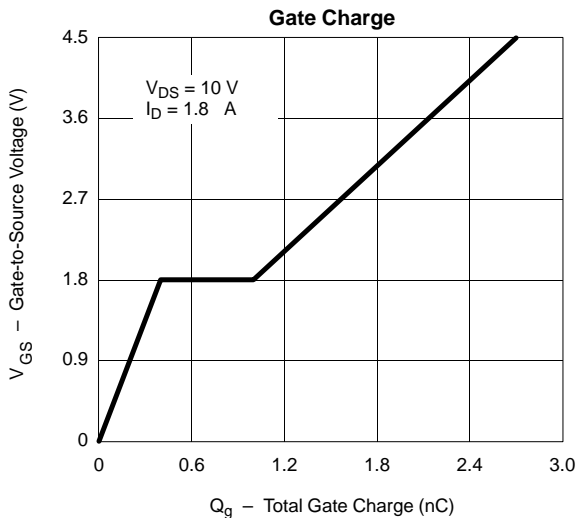
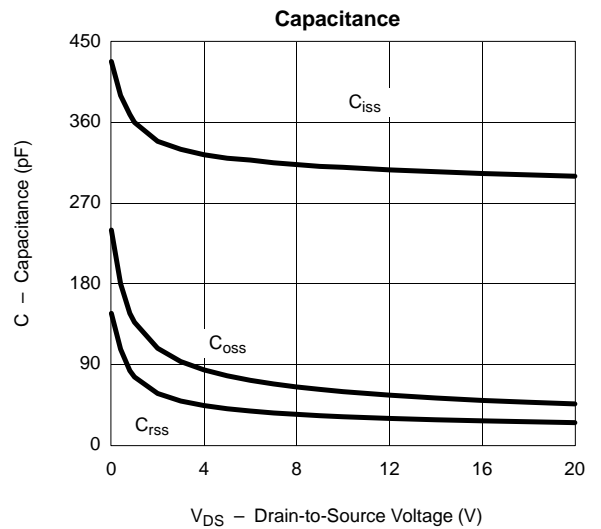
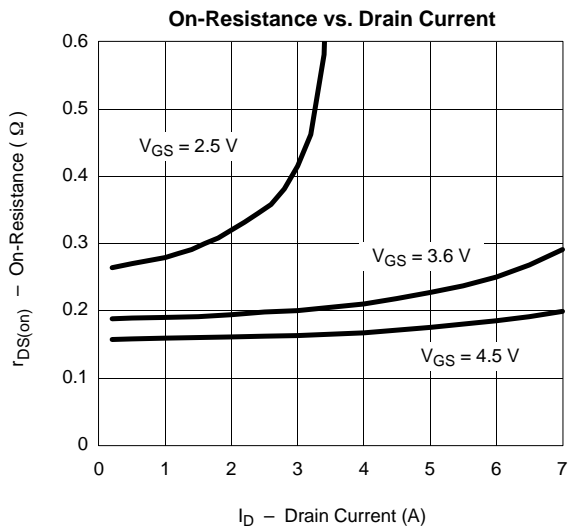
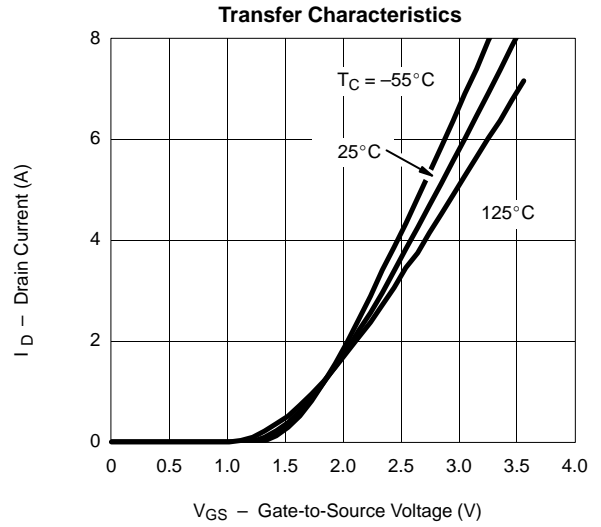
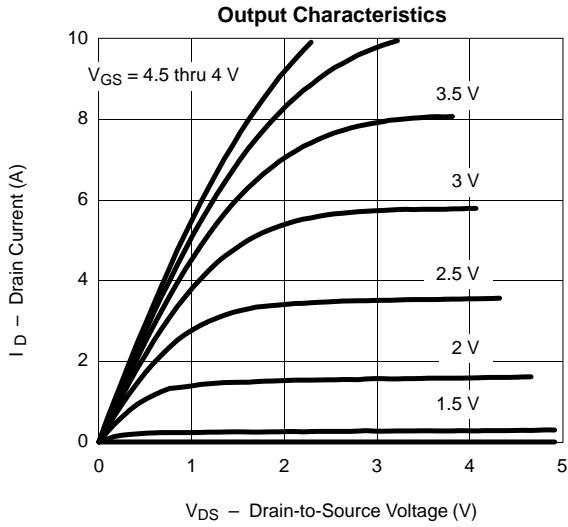



TYPICAL CHARACTERISTICS (25°C UNLESS NOTED) MOSFET

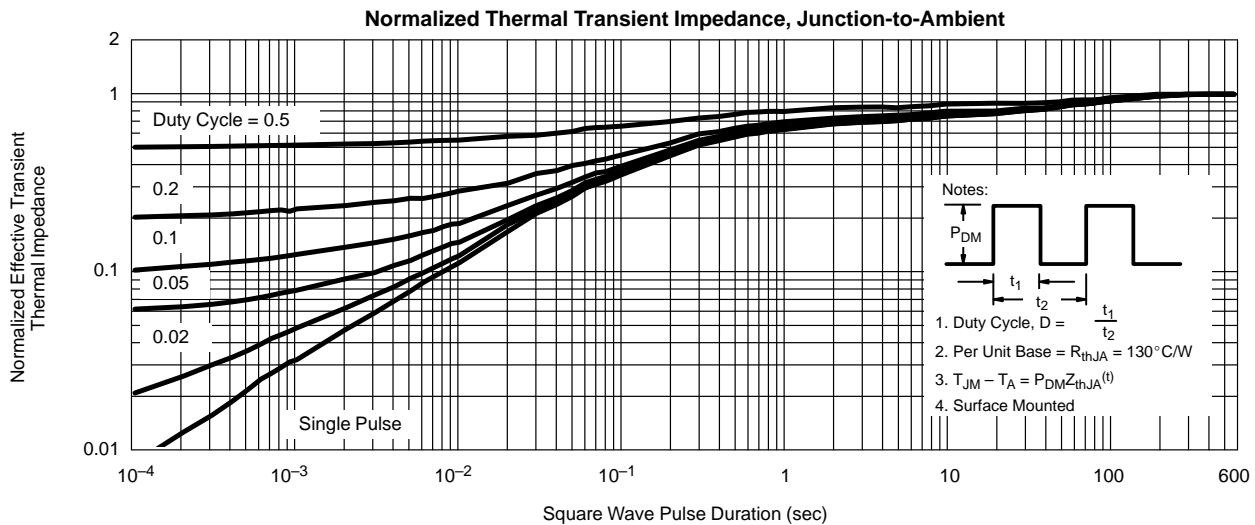
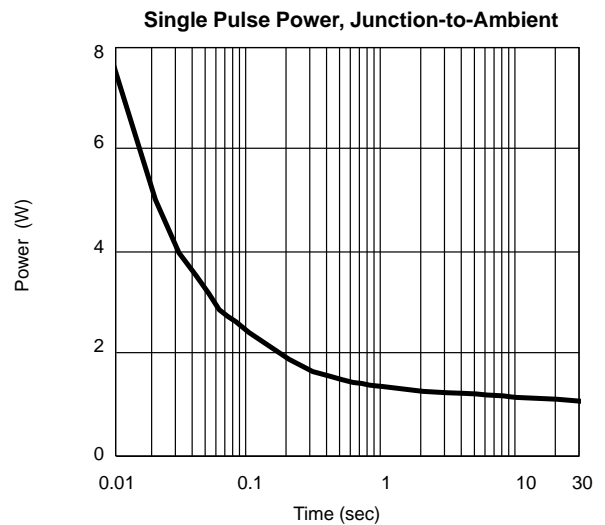
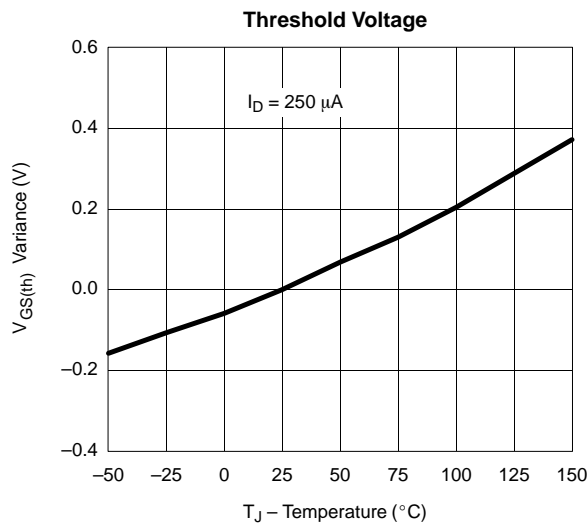
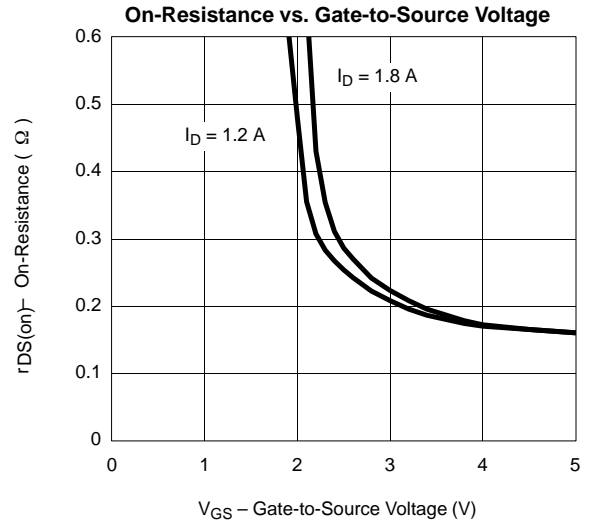
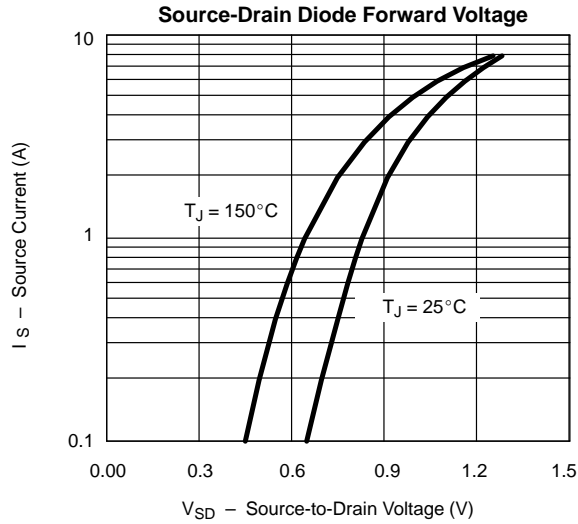



TYPICAL CHARACTERISTICS (25°C UNLESS NOTED) MOSFET

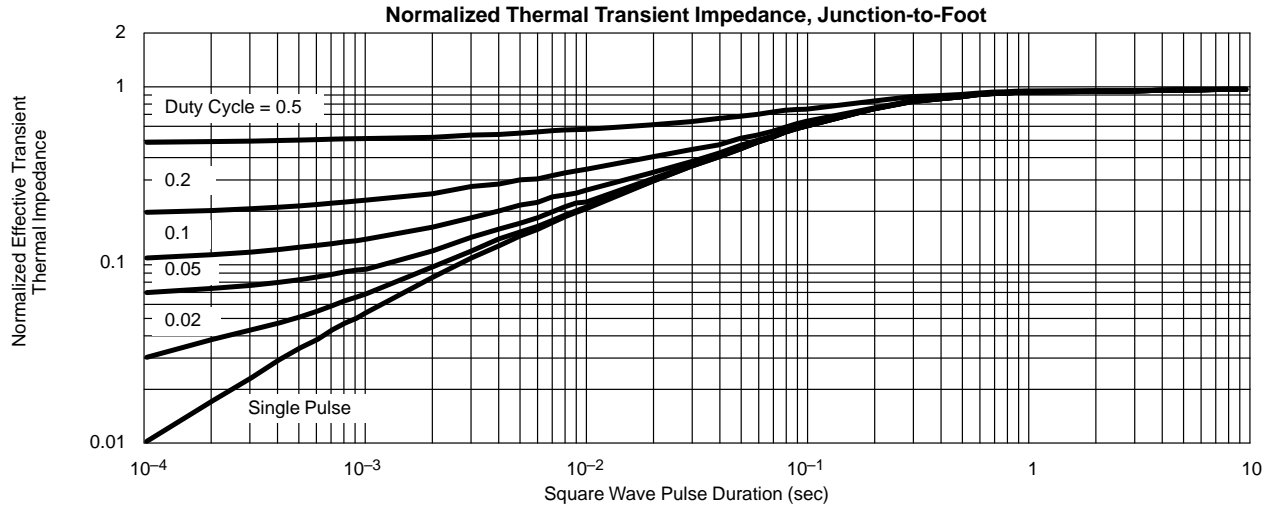

TYPICAL CHARACTERISTICS (25°C UNLESS NOTED) SCHOTTKY

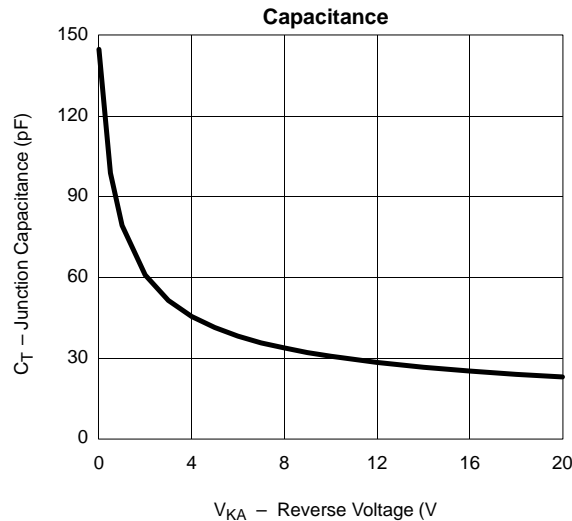
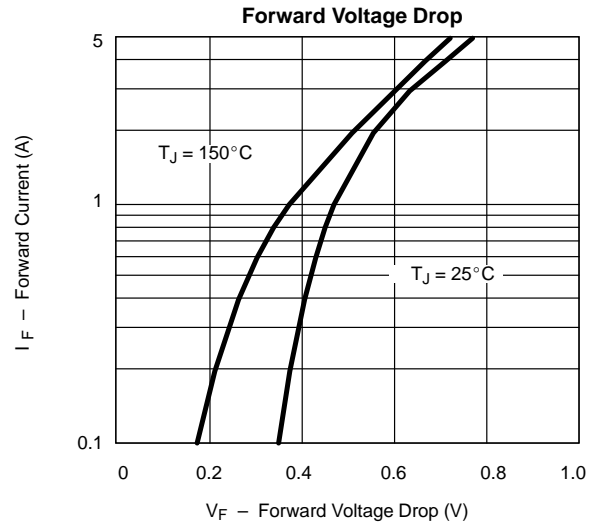
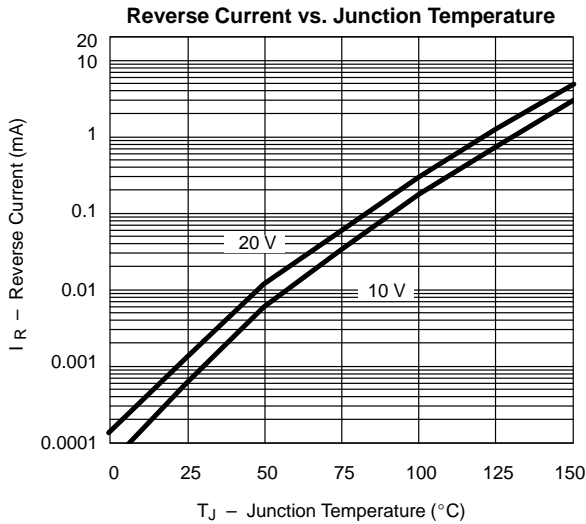



TYPICAL CHARACTERISTICS (25 °C UNLESS NOTED)

SCHOTTKY

