

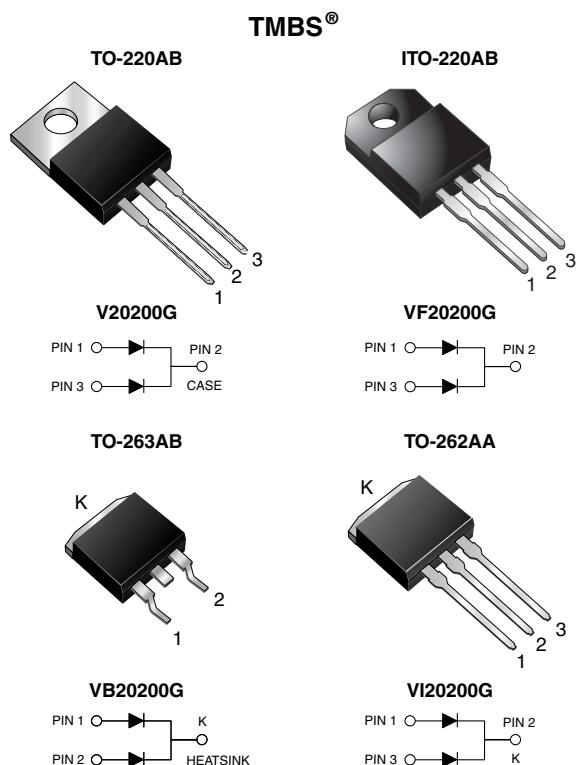

V20200G, VF20200G, VB20200G & VI20200G

Vishay General Semiconductor

Dual High-Voltage Trench MOS Barrier Schottky Rectifier

Ultra Low $V_F = 0.62$ V at $I_F = 5$ A

FEATURES

- Trench MOS Schottky technology
- Low forward voltage drop, low power losses
- High efficiency operation
- Low thermal resistance
- Meets MSL level 1, per J-STD-020, LF maximum peak of 245 °C (for TO-263AB package)
- Solder bath temperature 275 °C maximum, 10 s, per JESD 22-B106 (for TO-220AB, ITO-220AB and TO-262AA package)
- Compliant to RoHS directive 2002/95/EC and in accordance to WEEE 2002/96/EC

RoHS
COMPLIANT

TYPICAL APPLICATIONS

For use in high frequency converters, switching power supplies, freewheeling diodes, OR-ing diode, dc-to-dc converters and reverse battery protection.

MECHANICAL DATA

Case: TO-220AB, ITO-220AB, TO-263AB and TO-262AA

Molding compound meets UL 94 V-0 flammability rating

Base P/N-E3 - RoHS compliant, commercial grade

Terminals: Matte tin plated leads, solderable per J-STD-002 and JESD 22-B102

E3 suffix meets JESD 201 class 1A whisker test

Polarity: As marked

Mounting Torque: 10 in-lbs maximum

PRIMARY CHARACTERISTICS

$I_{F(AV)}$	2 x 10 A
V_{RRM}	200 V
I_{FSM}	110 A
V_F at $I_F = 10$ A	0.71 V
T_J max.	150 °C

MAXIMUM RATINGS ($T_A = 25$ °C unless otherwise noted)

PARAMETER	SYMBOL	V20200G	VF20200G	VB20200G	VI20200G	UNIT
Maximum repetitive peak reverse voltage	V_{RRM}		200			V
Maximum average forward rectified current (fig. 1) per device per diode	$I_{F(AV)}$		20 10			A
Peak forward surge current 8.3 ms single half sine-wave superimposed on rated load per diode	I_{FSM}		110			A
Non-repetitive avalanche energy at $T_J = 25$ °C, $L = 60$ mH per diode	E_{AS}		60			mJ
Peak repetitive reverse current at $t_p = 2$ μ s, 1 kHz, $T_J = 38$ °C \pm 2 °C per diode	I_{RRM}		0.5			A
Voltage rate of change (rated V_R)	dV/dt		10 000			V/ μ s
Isolation voltage (ITO-220AB only) from terminal to heatsink $t = 1$ min	V_{AC}		1500			V
Operating junction and storage temperature range	T_J, T_{STG}		- 40 to + 150			°C

ELECTRICAL CHARACTERISTICS (T _A = 25 °C unless otherwise noted)						
PARAMETER	TEST CONDITIONS		SYMBOL	TYP.	MAX.	UNIT
Breakdown voltage	I _R = 1.0 mA	T _J = 25 °C	V _{BR}	200 (minimum)	-	V
Instantaneous forward voltage per diode (1)	I _F = 5 A	T _J = 25 °C	V _F	0.86	-	V
	I _F = 10 A	T _J = 25 °C		1.23	1.70	
Reverse current per diode (2)	V _R = 180 V	T _J = 25 °C	I _R	1.9	-	μA
		T _J = 125 °C		1.6	-	mA
	V _R = 200 V	T _J = 25 °C		-	150	μA
		T _J = 125 °C		2.5	15	mA

Notes

(1) Pulse test: 300 μs pulse width, 1 % duty cycle

(2) Pulse test: Pulse width ≤ 40 ms

THERMAL CHARACTERISTICS (T _A = 25 °C unless otherwise noted)						
PARAMETER	SYMBOL	V20200G	VF20200G	VB20200G	VI20200G	UNIT
Typical thermal resistance per diode	R _{θJC}	3.2	5.5	3.2	3.2	°C/W

ORDERING INFORMATION (Example)					
PACKAGE	PREFERRED P/N	UNIT WEIGHT (g)	PACKAGE CODE	BASE QUANTITY	DELIVERY MODE
TO-220AB	V20200G-E3/4W	1.88	4W	50/tube	Tube
ITO-220AB	VF20200G-E3/4W	1.75	4W	50/tube	Tube
TO-263AB	VB20200G-E3/4W	1.39	4W	50/tube	Tube
TO-263AB	VB20200G-E3/8W	1.39	8W	800/reel	Tape and reel
TO-262AA	VI20200G-E3/4W	1.45	4W	50/tube	Tube

RATINGS AND CHARACTERISTICS CURVES

(T_A = 25 °C unless otherwise noted)

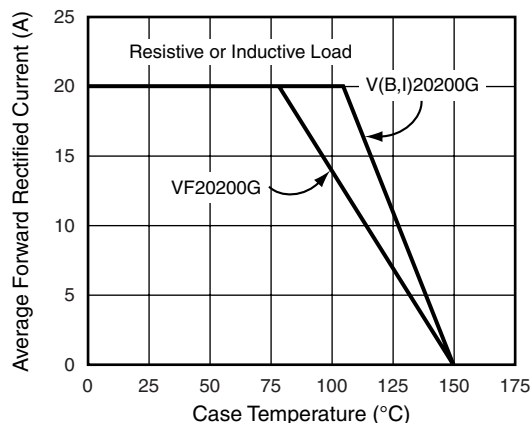

Figure 1. Maximum Forward Current Derating Curve

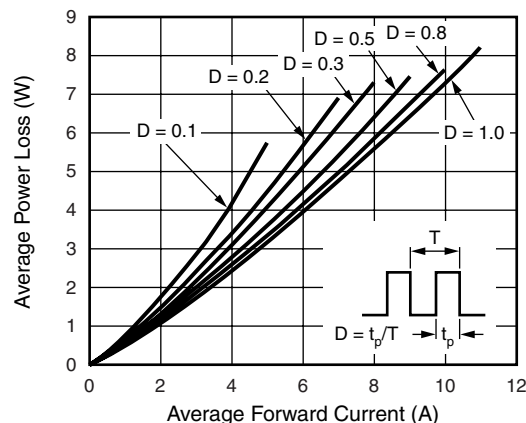

Figure 2. Forward Power Loss Characteristics Per Diode



V20200G, VF20200G, VB20200G & VI20200G

Vishay General Semiconductor

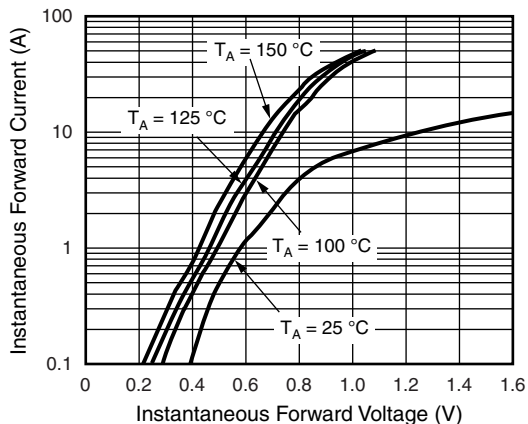

Figure 3. Typical Instantaneous Forward Characteristics Per Diode

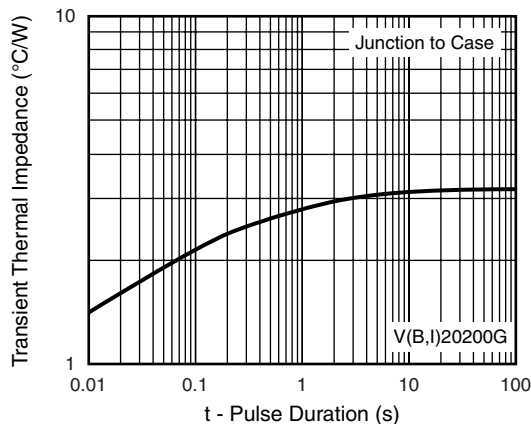

Figure 6. Typical Transient Thermal Impedance Per Diode

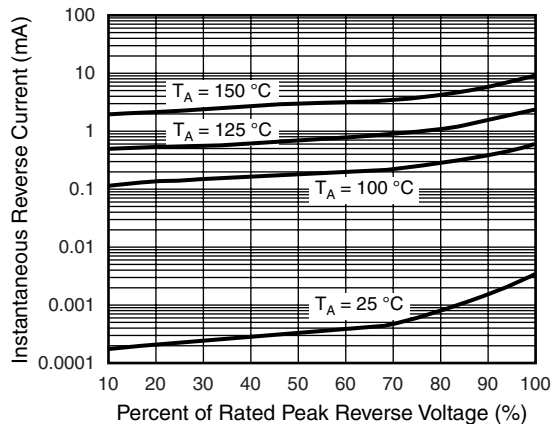

Figure 4. Typical Reverse Characteristics Per Diode

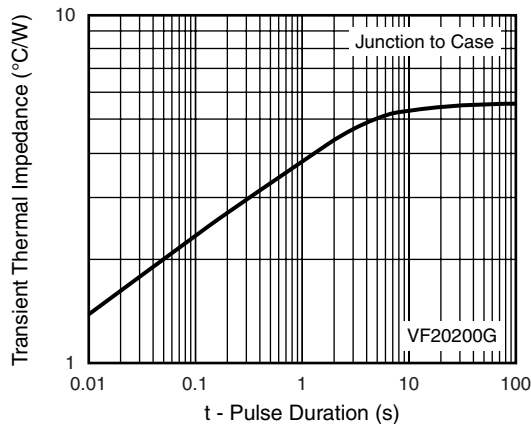

Figure 7. Typical Transient Thermal Impedance Per Diode

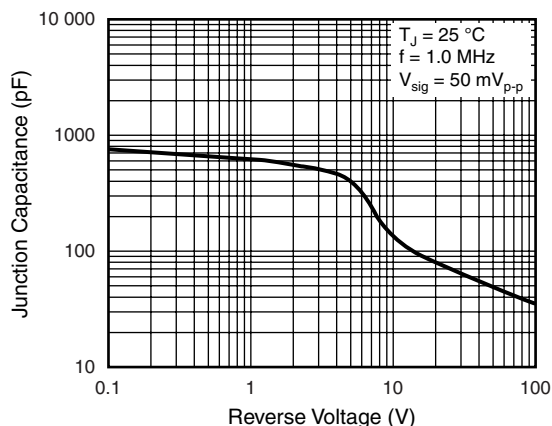

Figure 5. Typical Junction Capacitance Per Diode

V20200G, VF20200G, VB20200G & VI20200G

Vishay General Semiconductor



PACKAGE OUTLINE DIMENSIONS in inches (millimeters)

TO-220AB

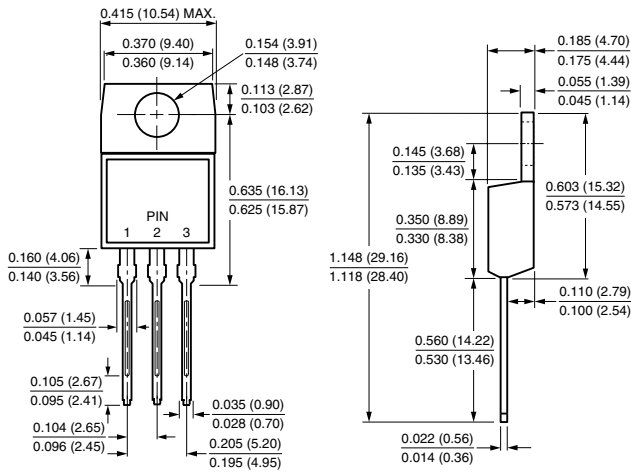

ITO-220AB

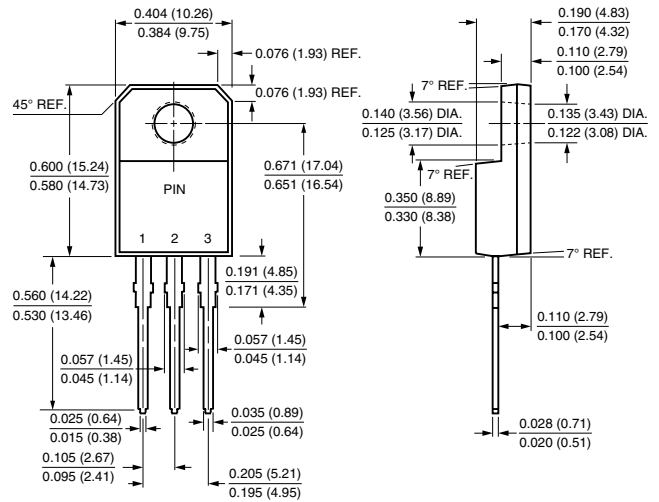

TO-262AA

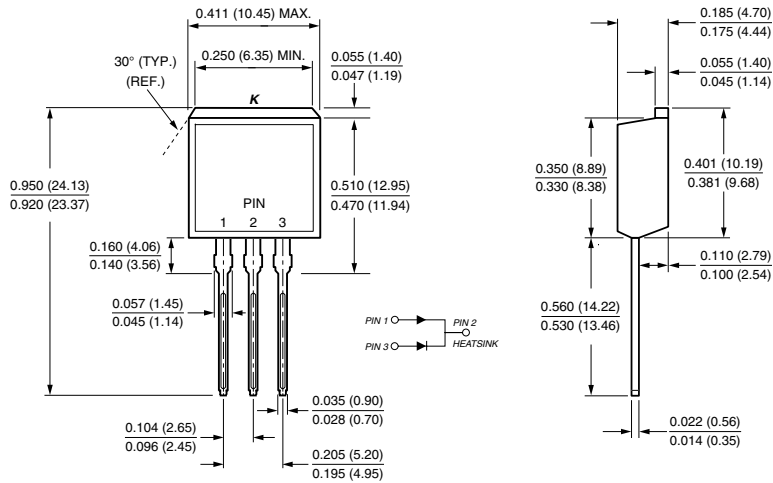

TO-263AB

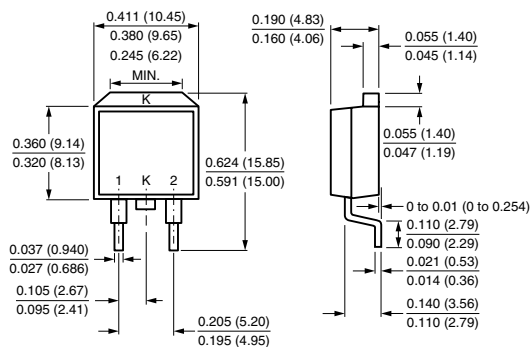

Mounting Pad Layout

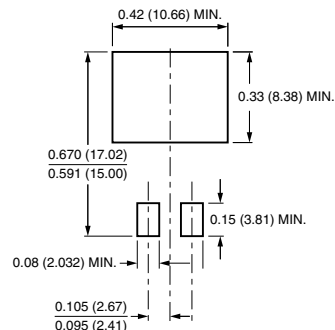



Disclaimer

ALL PRODUCT, PRODUCT SPECIFICATIONS AND DATA ARE SUBJECT TO CHANGE WITHOUT NOTICE TO IMPROVE RELIABILITY, FUNCTION OR DESIGN OR OTHERWISE.

Vishay Intertechnology, Inc., its affiliates, agents, and employees, and all persons acting on its or their behalf (collectively, "Vishay"), disclaim any and all liability for any errors, inaccuracies or incompleteness contained in any datasheet or in any other disclosure relating to any product.

Vishay makes no warranty, representation or guarantee regarding the suitability of the products for any particular purpose or the continuing production of any product. To the maximum extent permitted by applicable law, Vishay disclaims (i) any and all liability arising out of the application or use of any product, (ii) any and all liability, including without limitation special, consequential or incidental damages, and (iii) any and all implied warranties, including warranties of fitness for particular purpose, non-infringement and merchantability.

Statements regarding the suitability of products for certain types of applications are based on Vishay's knowledge of typical requirements that are often placed on Vishay products in generic applications. Such statements are not binding statements about the suitability of products for a particular application. It is the customer's responsibility to validate that a particular product with the properties described in the product specification is suitable for use in a particular application. Parameters provided in datasheets and/or specifications may vary in different applications and performance may vary over time. All operating parameters, including typical parameters, must be validated for each customer application by the customer's technical experts. Product specifications do not expand or otherwise modify Vishay's terms and conditions of purchase, including but not limited to the warranty expressed therein.

Except as expressly indicated in writing, Vishay products are not designed for use in medical, life-saving, or life-sustaining applications or for any other application in which the failure of the Vishay product could result in personal injury or death. Customers using or selling Vishay products not expressly indicated for use in such applications do so at their own risk and agree to fully indemnify and hold Vishay and its distributors harmless from and against any and all claims, liabilities, expenses and damages arising or resulting in connection with such use or sale, including attorneys fees, even if such claim alleges that Vishay or its distributor was negligent regarding the design or manufacture of the part. Please contact authorized Vishay personnel to obtain written terms and conditions regarding products designed for such applications.

No license, express or implied, by estoppel or otherwise, to any intellectual property rights is granted by this document or by any conduct of Vishay. Product names and markings noted herein may be trademarks of their respective owners.