

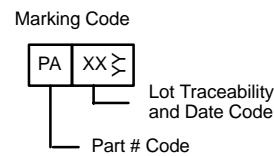

Dual N-Channel 20-V (D-S) MOSFET

TrenchFET[®]
Power MOSFETs
2.5-V Rated

PRODUCT SUMMARY		
V_{DS} (V)	$r_{DS(on)}$ (Ω)	I_D (A)
20	0.385 @ $V_{GS} = 4.5$ V	0.70
	0.630 @ $V_{GS} = 2.5$ V	0.54

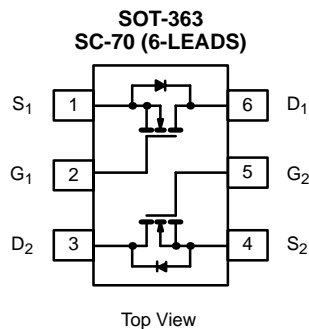

ABSOLUTE MAXIMUM RATINGS ($T_A = 25^\circ\text{C}$ UNLESS OTHERWISE NOTED)					
Parameter		Symbol	5 secs	Steady State	Unit
Drain-Source Voltage		V_{DS}	20		V
Gate-Source Voltage		V_{GS}	± 12		
Continuous Drain Current ($T_J = 150^\circ\text{C}$) ^a	$T_A = 25^\circ\text{C}$	I_D	0.70	0.66	A
	$T_A = 85^\circ\text{C}$		0.50	0.48	
Pulsed Drain Current		I_{DM}	1.0		
Continuous Source Current (Diode Conduction) ^a		I_S	0.25	0.23	W
Maximum Power Dissipation ^a	$T_A = 25^\circ\text{C}$	P_D	0.30	0.27	
	$T_A = 85^\circ\text{C}$		0.16	0.14	
Operating Junction and Storage Temperature Range		T_J, T_{stg}	-55 to 150		$^\circ\text{C}$

THERMAL RESISTANCE RATINGS					
Parameter		Symbol	Typical	Maximum	Unit
Maximum Junction-to-Ambient ^a	$t \leq 5$ sec	R_{thJA}	360	415	$^\circ\text{C/W}$
	Steady State		400	460	
Maximum Junction-to-Foot (Drain)		R_{thJF}	300	350	

Notes

a. Surface Mounted on 1" x 1" FR4 Board.

SPECIFICATIONS (T_J = 25 °C UNLESS OTHERWISE NOTED)

Parameter	Symbol	Test Condition	Min	Typ	Max	Unit
Static						
Gate Threshold Voltage	V _{GS(th)}	V _{DS} = V _{GS} , I _D = 250 μA	0.6		1.5	V
Gate-Body Leakage	I _{GSS}	V _{DS} = 0 V, V _{GS} = ± 12 V			± 100	nA
Zero Gate Voltage Drain Current	I _{DSS}	V _{DS} = 16 V, V _{GS} = 0 V			1	μA
		V _{DS} = 16 V, V _{GS} = 0 V, T _J = 85 °C			5	
On-State Drain Current ^a	I _{D(on)}	V _{DS} ≥ 5 V, V _{GS} = 4.5 V	1.0			A
Drain-Source On-State Resistance ^a	r _{DS(on)}	V _{GS} = 4.5 V, I _D = 0.66 A		0.320	0.385	Ω
		V _{GS} = 2.5 V, I _D = 0.40 A		0.560	0.630	
Forward Transconductance ^a	g _{fs}	V _{DS} = 10 V, I _D = 0.66 A		1.5		S
Diode Forward Voltage ^a	V _{SD}	I _S = 0.23 A, V _{GS} = 0 V		0.8	1.2	V
Dynamic^b						
Total Gate Charge	Q _g	V _{DS} = 10 V, V _{GS} = 4.5 V, I _D = 0.66 A		0.8	1.2	nC
Gate-Source Charge	Q _{gs}			0.06		
Gate-Drain Charge	Q _{gd}			0.30		
Turn-On Delay Time	t _{d(on)}	V _{DD} = 10 V, R _L = 20 Ω I _D ≅ 0.5 A, V _{GEN} = 4.5 V, R _G = 6 Ω		10	20	ns
Rise Time	t _r			16	30	
Turn-Off Delay Time	t _{d(off)}			10	20	
Fall Time	t _f			10	20	
Source-Drain Reverse Recovery Time	t _{rr}	I _F = 0.23 A, di/dt = 100 A/μs		20	40	

Notes

- a. Pulse test; pulse width ≤ 300 μs, duty cycle ≤ 2%.
b. Guaranteed by design, not subject to production testing.

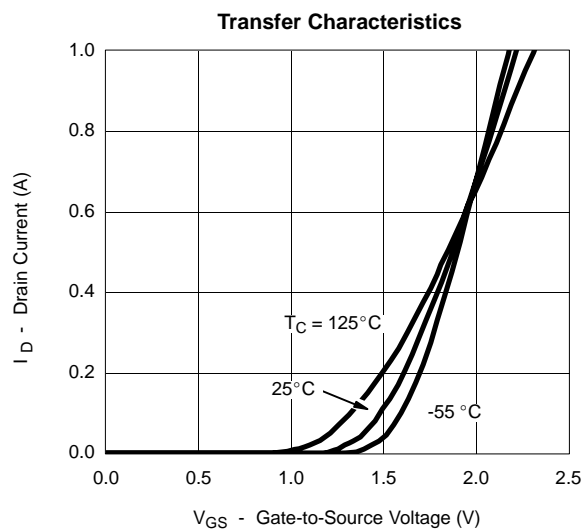
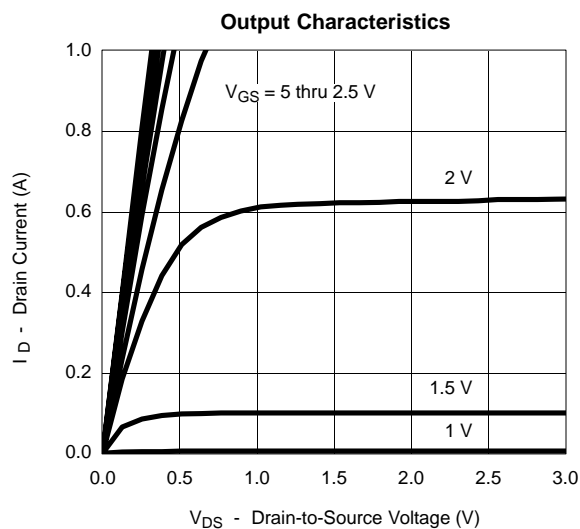
TYPICAL CHARACTERISTICS (25 °C UNLESS NOTED)

TYPICAL CHARACTERISTICS (25°C UNLESS NOTED)

On-Resistance vs. Drain Current

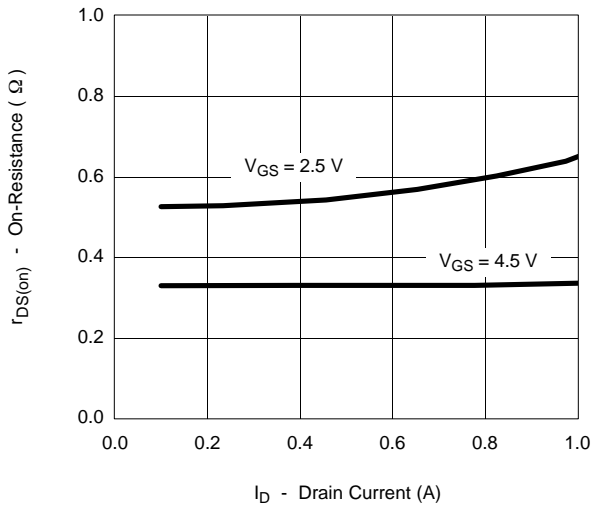

Capacitance

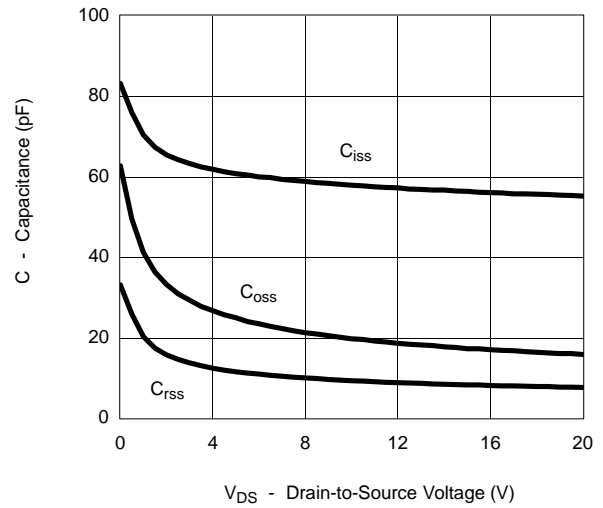

Gate Charge

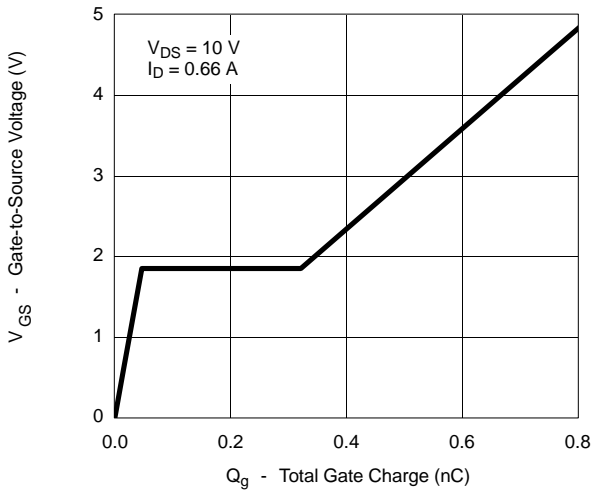

On-Resistance vs. Junction Temperature

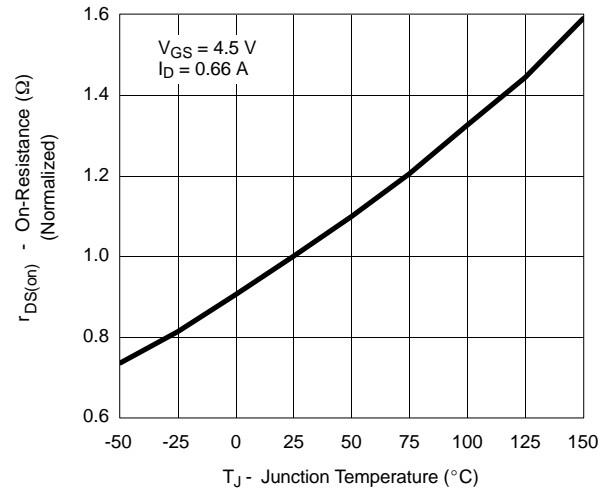

Source-Drain Diode Forward Voltage

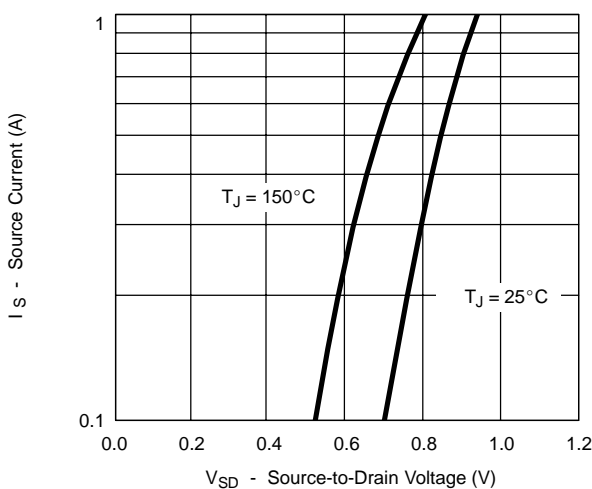

On-Resistance vs. Gate-to-Source Voltage

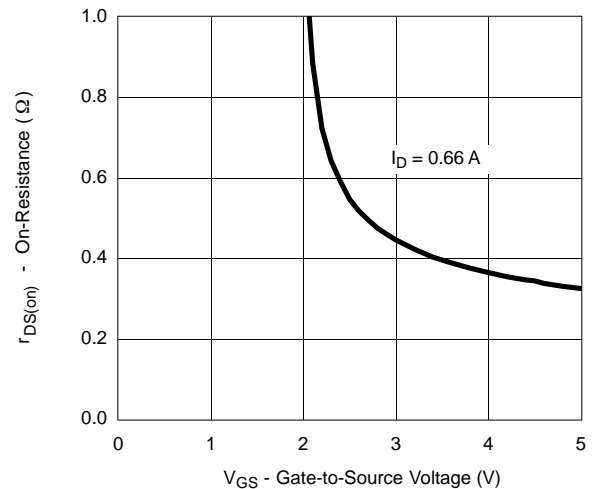

TYPICAL CHARACTERISTICS (25°C UNLESS NOTED)

