

S and SR series

Washable rocker and paddle switches

Distinctive features and specifications



- Sealed**
 - Secure assembly of the two case parts
 - Internally sealed bushing
 - Epoxy sealed terminals
- Process compatible (S series)**
 - Wave solderable
 - Washable
- Optional ESD protection**

ELECTRICAL SPECIFICATIONS

- Max. current/voltage rating with resistive load :
 - silver contacts (A or 1) : 2A 250VAC - 5A 125VAC - 4A 30VDC
 - brass, gold plated contacts (CD or 0) : 0,4VA 20VAC or DC
 - silver, gold plated contacts (AD or 2) : 2A 250VAC - 5A 125VAC - 4A 30VDC (300mA 30VDC for gold plating)
- Initial contact resistance : 10 mΩ max.
- Insulation resistance : 1.000 MΩ min.
- Dielectric strength : 1.000 Vrms 50 Hz min.
- Electrical life with nominal load :

Contacts	Number of cycles	
	2 positions	3 positions
A or 1	40.000	40.000
CD or 0	100.000	50.000
AD or 2	40.000	40.000

MATERIALS

- Case and cover : UL94-V0, polyamide, glass filled or PES
- Actuator : polyamide
- Contacts
 - CD or 0** : brass, gold plated
 - A or 1** : silver
 - AD or 2** : silver, gold plated
- Terminal seal : epoxy

GENERAL SPECIFICATIONS

- Mechanical strength :
Terminals are strengthened by a bracket or a ground plate ensuring the rigidity of the switch on the board. Actuator strength is 10N max.
- Operating temperature : -20°C to +85°C
- Storage temperature : -40°C to +85°C
- Moisture :
The insulating materials employed and the complete seal permit the switches to withstand a 56 days moisture test (IEC 68-2-3).
- Soldering - thermal shock (S series only) :
The switches are especially designed for flow soldering at 260°C during 5 seconds owing to high temperature polymer parts.
- Iron soldering (SR series) : 300°C 5 sec. max.
- Solderability : The switches are tested at 235°C according to IEC 68-2-20 after accelerated aging.

AGENCY APPROVALS



Availability : consult factory for details of approved models.

Marking : to order switches marked UL, complete appropriate box of ordering format.

S series

Washable rocker and paddle switches

Overview

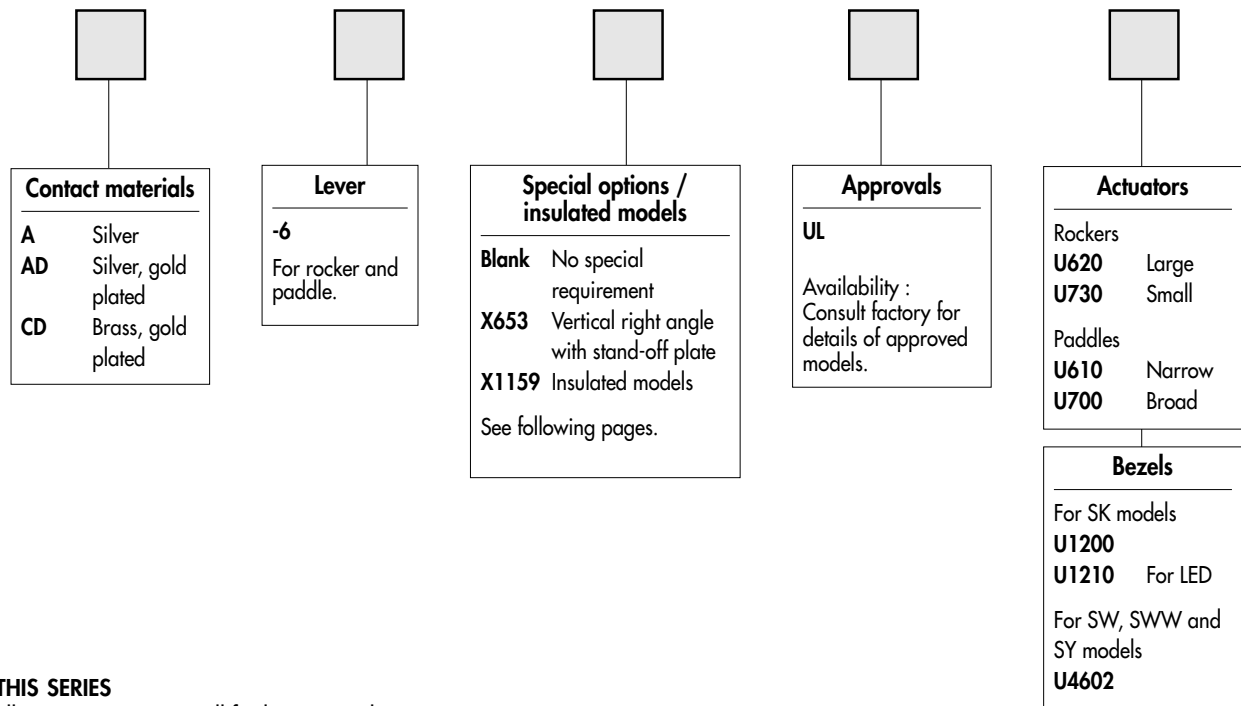
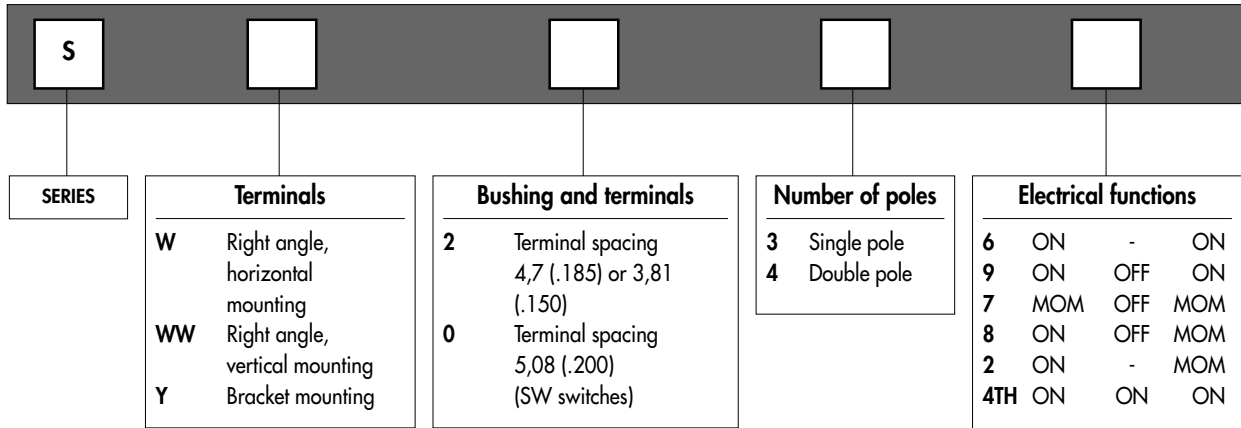

ABOUT THIS SERIES

On the following pages, you will find successively :
 - model structure of switches
 - options in the same order as above
 Specifications are on previous page.

Dimensions : first dimensions are in mm while inches are shown as bracketted numbers.



NOTICE : please note that not all combinations of above numbers are available. Refer to the following pages for further information.



Packaging unit : 25 pieces to 50 pieces depending on models.

S series

Washable rocker and paddle switches

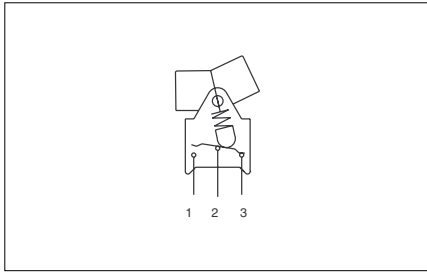
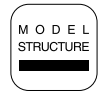

- Straight PC or right angle terminals
- Models with snap-in mounting (SK)
- Terminal spacing 4,7 (.185) or 5,08 (.200) on SW switches
- 1 and 2 pole configurations

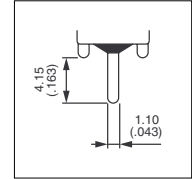

MODEL STRUCTURE



Shown with rocker U620

Right angle terminals - horizontal - spacing 4,7 (.185)



	Single pole	Double pole	III	II	I
SW236-6	SW246-6	ON	-	ON	
SW239-6	SW249-6	ON	OFF	ON	
SW237-6	SW247-6	MOM	OFF	MOM	
SW238-6	SW248-6	ON	OFF	MOM	
SW232-6	SW242-6	ON	-	MOM	
	SW244TH-6*	ON	ON	ON	

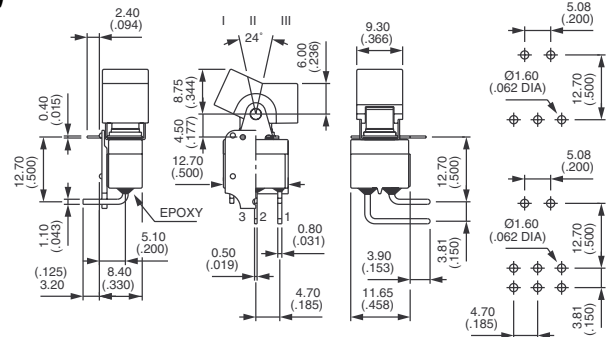

Single pole with stand-off plate, double pole without.

Right angle terminals - vertical



	Single pole	Double pole	III	II	I
SWW236-6	SWW246-6	ON	-	ON	
SWW239-6	SWW249-6	ON	OFF	ON	
SWW237-6	SWW247-6	MOM	OFF	MOM	
SWW238-6	SWW248-6**	ON	OFF	MOM	
SWW232-6	SWW242-6**	ON	-	MOM	
	SWW244TH-6*	ON	ON	ON	

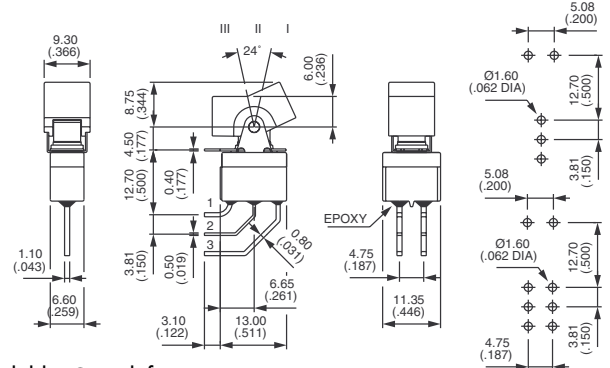

** Functions 2 and 8 : reversed connection available. Consult factory.

Bracket mounting



	Single pole	Double pole	III	II	I
SY236-6	SY246-6	ON	-	ON	
SY239-6	SY249-6	ON	OFF	ON	
SY237-6	SY247-6	MOM	OFF	MOM	
SY238-6	SY248-6	ON	OFF	MOM	
SY232-6	SY242-6	ON	-	MOM	
	SY244TH-6*	ON	ON	ON	

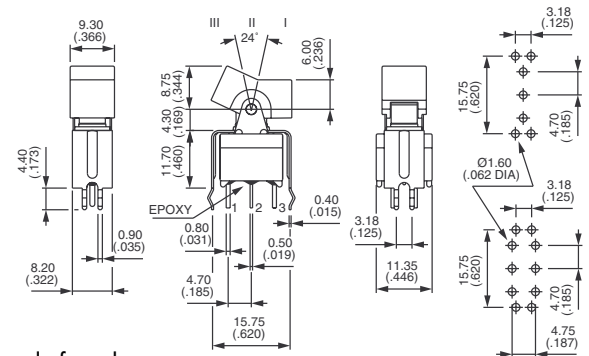

* Function 4 : SP in DP case - TH connection, see end of catalogue.



S series

Washable rocker and paddle switches

Right angle terminals - horizontal - spacing 5,08 (.200)



	III	II	I
Single pole			
Double pole			
SW036-6	SW046-6	ON - ON	
SW039-6	SW049-6	ON OFF ON	
SW037-6	SW047-6	MOM OFF MOM	
SW038-6	SW048-6	ON OFF MOM	
SW032-6	SW042-6	ON - MOM	
	SW044TH-6*	ON ON ON	

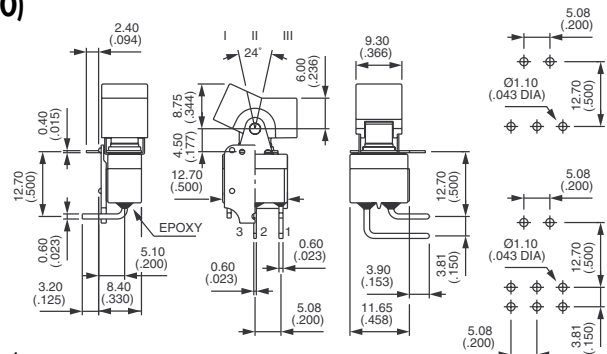

Single pole with stand-off plate, double pole without.

Straight PC terminals - snap-in mounting



	III	II	I
Single pole			
Double pole			
SK236-6	SK246-6	ON - ON	
SK239-6	SK249-6	ON OFF ON	
SK237-6	SK247-6	MOM OFF MOM	
SK238-6	SK248-6	ON OFF MOM	
SK232-6	SK242-6	ON - MOM	
	SK244TH-6*	ON ON ON	

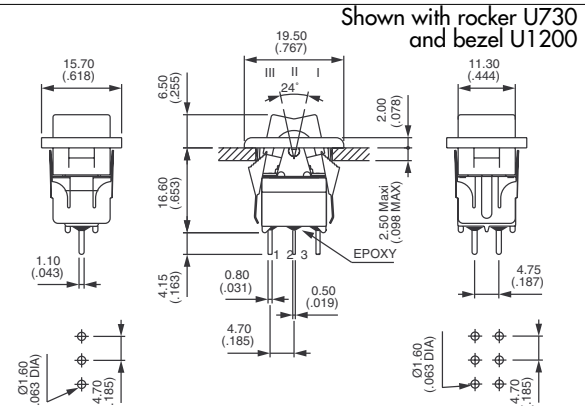

Shown with rocker U730 and bezel U1200

* Function 4 : SP in DP case - TH connection, see end of catalogue.

PANEL CUT-OUT

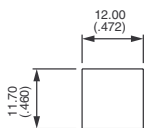

With rocker **U730**
or paddle **U700**

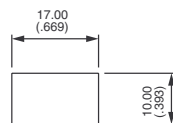

With rocker **U620**
or paddle **U610**

For SK only

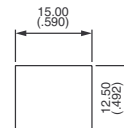

S series

Washable rocker and paddle switches



CONTACT MATERIALS

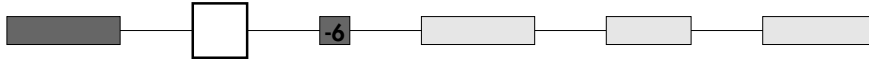

- A Silver
- AD Silver, gold plated
- CD Brass, gold plated

SPECIAL OPTIONS / INSULATED MODELS

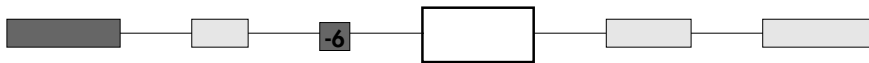

X653 Vertical right angle with stand-off plate

Shown with rocker U620



Single pole

- SWW236-6 X653
- SWW239-6 X653
- SWW237-6 X653
- SWW238-6 X653
- SWW232-6 X653

	III	II	I
SWW236-6 X653	ON	-	ON
SWW239-6 X653	ON	OFF	ON
SWW237-6 X653	MOM	OFF	MOM
SWW238-6 X653	ON	OFF	MOM
SWW232-6 X653	ON	-	MOM

Double pole

- SWW246-6 X653
- SWW249-6 X653
- SWW247-6 X653
- SWW248-6 X653**
- SWW242-6 X653**
- SWW244TH-6 X653*

	III	II	I
SWW246-6 X653	ON	-	ON
SWW249-6 X653	ON	OFF	ON
SWW247-6 X653	MOM	OFF	MOM
SWW248-6 X653**	ON	OFF	MOM
SWW242-6 X653**	ON	-	MOM
SWW244TH-6 X653*	ON	ON	ON

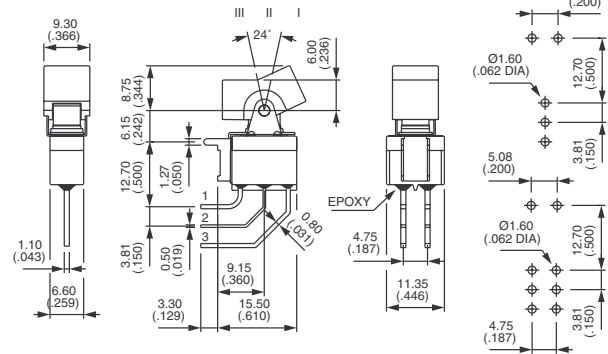

* Function 4 : SP in DP case - TH connection, see end of catalogue.
 ** Functions 2 and 8 : reversed connection available. Consult factory.

X601 Silver plated brass contacts
 Current/voltage rating for an electrical life of 20.000 cycles :
 0,2A 250VAC - 0,4A 125VAC - 0,5A 30VDC
 Minimum quantity : 5.000 per type and shipment.



S series

Washable rocker and paddle switches

SPECIAL OPTIONS / INSULATED MODELS (continued)

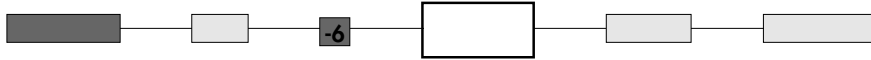

X1159 Insulated model protected against E.S.D. up to 12 KV - Horizontal right angle



	III	II	I
Single pole			
SW236-6 X1159	ON	-	ON
SW239-6 X1159	ON	OFF	ON
SW237-6 X1159	MOM	OFF	MOM
SW238-6 X1159	ON	OFF	MOM
SW232-6 X1159	ON	-	MOM
Double pole			
SW246-6 X1159	ON	-	ON
SW249-6 X1159	ON	OFF	ON
SW247-6 X1159	MOM	OFF	MOM
SW248-6 X1159	ON	OFF	MOM
SW242-6 X1159	ON	-	MOM
SW244TH-6 X1159*	ON	ON	ON

Shown with rocker U620

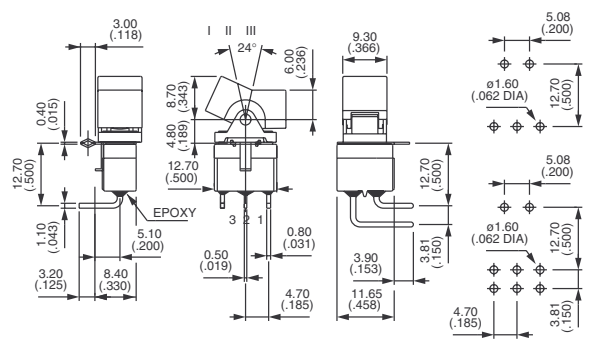

X1159 Insulated model protected against E.S.D. up to 12 KV - Vertical right angle



	III	II	I
Single pole			
SWW236-6 X1159	ON	-	ON
SWW239-6 X1159	ON	OFF	ON
SWW237-6 X1159	MOM	OFF	MOM
SWW238-6 X1159	ON	OFF	MOM
SWW232-6 X1159	ON	-	MOM
Double pole			
SWW246-6 X1159	ON	-	ON
SWW249-6 X1159	ON	OFF	ON
SWW247-6 X1159	MOM	OFF	MOM
SWW248-6 X1159**	ON	OFF	MOM
SWW242-6 X1159**	ON	-	MOM
SWW244TH-6 X1159*	ON	ON	ON

Shown with rocker U620

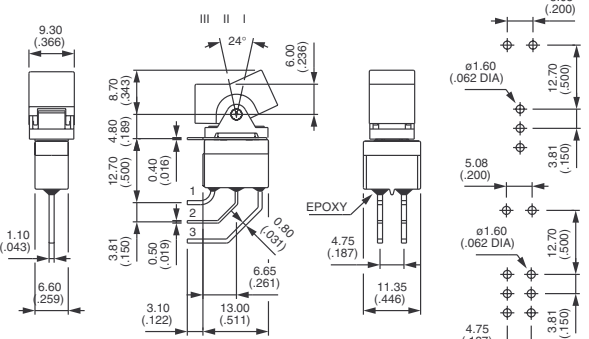

X1159 Insulated model protected against E.S.D. up to 12 KV - Straight PC terminals - bracket mounting



	III	II	I
Single pole			
SY236-6 X1159	ON	-	ON
SY239-6 X1159	ON	OFF	ON
SY237-6 X1159	MOM	OFF	MOM
SY238-6 X1159	ON	OFF	MOM
SY232-6 X1159	ON	-	MOM
Double pole			
SY246-6 X1159	ON	-	ON
SY249-6 X1159	ON	OFF	ON
SY247-6 X1159	MOM	OFF	MOM
SY248-6 X1159**	ON	OFF	MOM
SY242-6 X1159**	ON	-	MOM
SY244TH-6 X1159*	ON	ON	ON

Shown with rocker U620

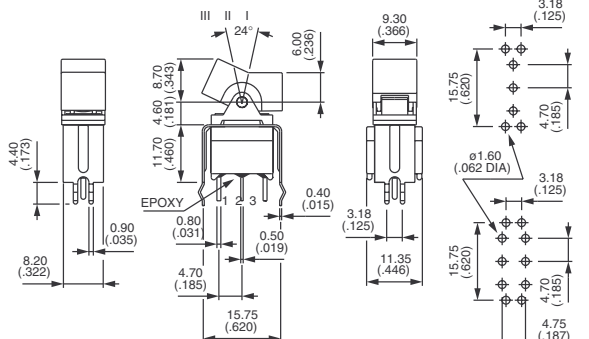

* Function 4 : SP in DP case - TH connection, see end of catalogue. ** Functions 2 and 8 : reversed connection available. Consult factory.

Above models available with all actuators shown on next page.

S series

Washable rocker and paddle switches



AGENCY APPROVAL

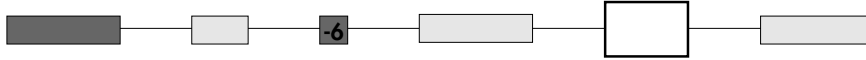

UL

Availability : consult factory for details of approved models.

Marking : to order switches marked with the UL symbol, complete above box with "UL".

Blank : no agency approval required.

ACTUATORS

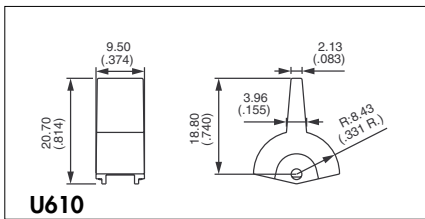
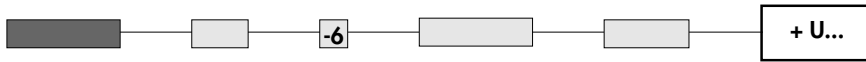

U610

Narrow paddle

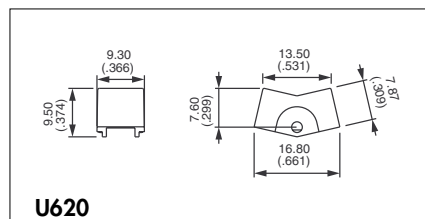

U620

Large rocker

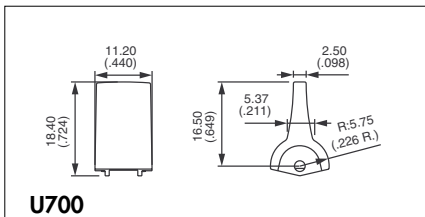

U700

Broad paddle

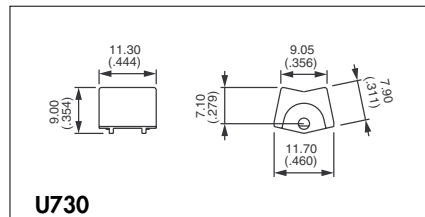

U730

Small rocker

Actuator colours	
Replace last "0" by number	
1	blue
1/4	dark blue
2	black
3	green
4	grey
5	yellow
6	red
7	ivory
7/1	white
9	orange



U610 and U620 not available on SK models

Bezels for SK model (snap-in)

Add bezel part number to actuator part number.

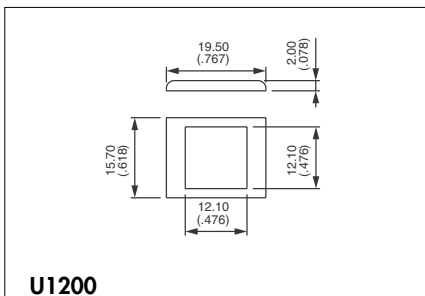

U1200

Bezel

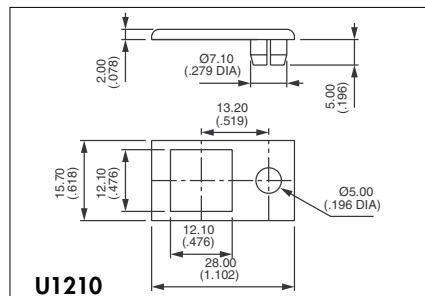

U1210

Bezel for LED Ø 5 (.196) - not supplied

Bezel for SW - SWW and SY models

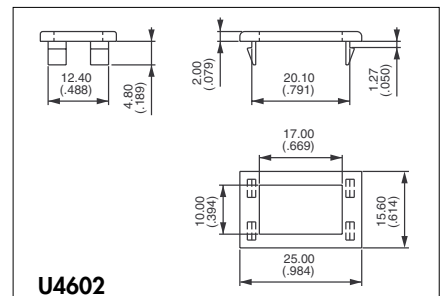

U4602

Black bezel - for rocker U620 only

SR series

Washable rocker and paddle switches

Overview

MODEL
STRUCTURE

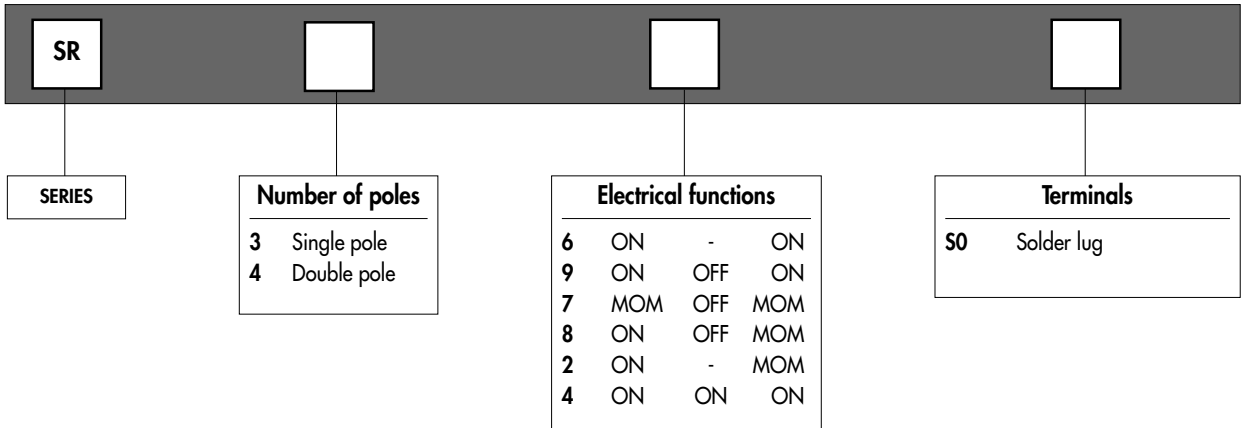

OPTIONS

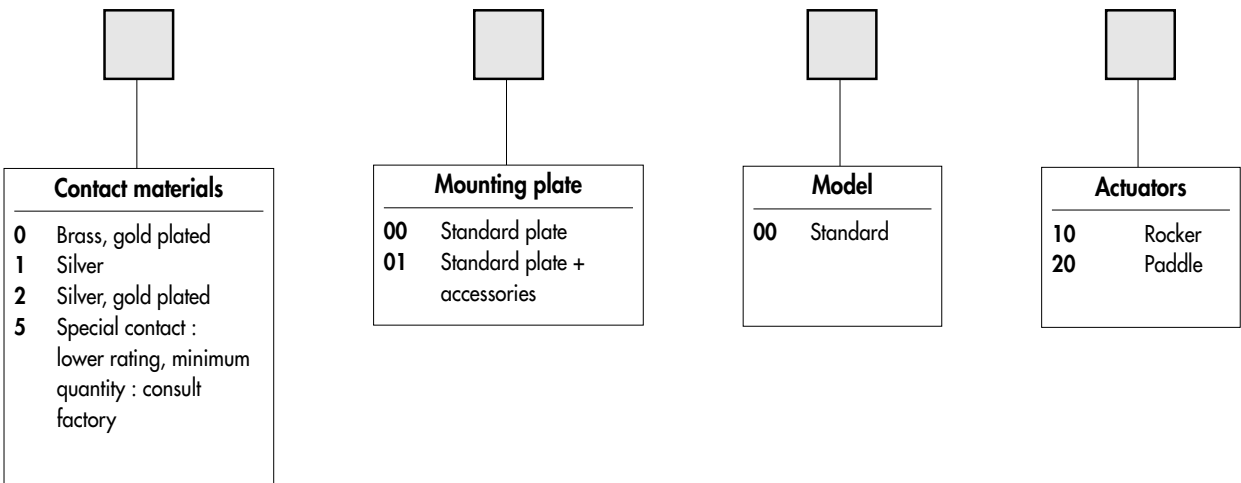

D

ABOUT THIS SERIES

On the following pages, you will find successively :

- model structure of switches
- options in the same order as above

Specifications are at the beginning of this section (S and SR series).

Dimensions : first dimensions are in mm while inches are shown as bracketted numbers.



Packaging unit : 20 pieces.

SR series

Washable rocker and paddle switches

Solder lug terminals

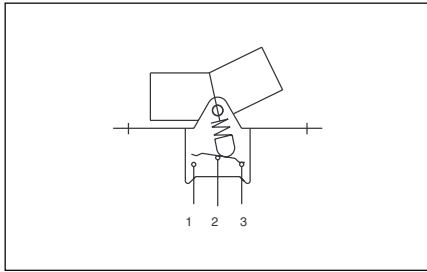
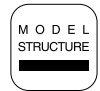

- 1 and 2 pole configurations
- Iron soldering 300°C max. 5 seconds max.

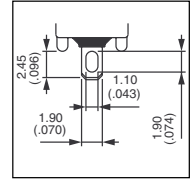

MODEL
STRUCTURE

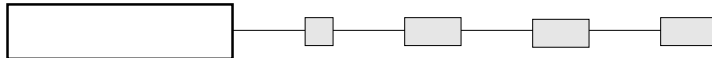

Shown with standard mounting plate (code 00)

Solder lug terminals



Single pole Double pole

SR3650	SR4650
SR3950	SR4950
SR3750	SR4750
SR3850	SR4850
SR3250	SR4250
	SR4450*

III	II	I
ON	-	ON
ON	OFF	ON
MOM	OFF	MOM
ON	OFF	MOM
ON	-	MOM
ON	ON	ON

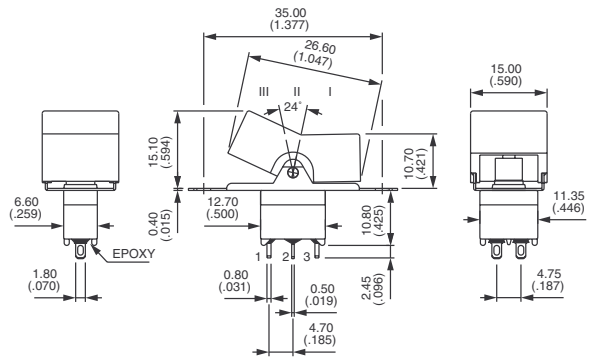

* Function 4 : SP in DP case - TH connection, see end of catalogue.

PANEL CUT-OUT

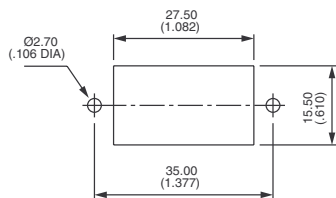



SR series

Washable rocker and paddle switches

CONTACT MATERIALS

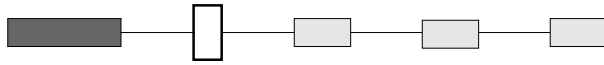

- 0 Brass, gold plated
- 1 Silver
- 2 Silver, gold plated
- 5 Special contact, lower rating, minimum quantity : consult factory.

MOUNTING PLATE

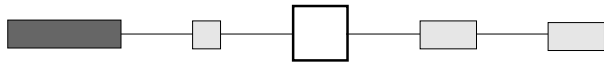

- 00 Standard mounting plate
- 01 Standard mounting plate + mounting accessories (spacers, screws and nuts)

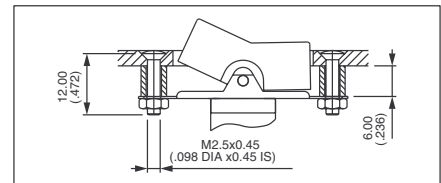

ACTUATORS

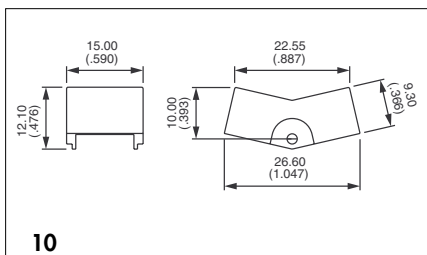
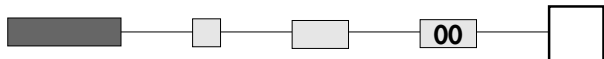

10
Rocker

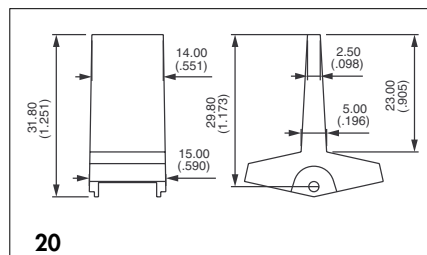

20
Paddle

Actuator colours	
Replace "0" by number	
1	blue
1/4	dark blue
2	black
3	green
4	grey
5	yellow
6	red
7	ivory
7/1	white
9	orange