



Complementary N- and P-Channel 20-V (D-S) MOSFET

PRODUCT SUMMARY			
	V _{DS} (V)	r _{DS(on)} (Ω)	I _D (mA)
N-Channel	20	0.70 @ V _{GS} = 4.5 V	600
		0.85 @ V _{GS} = 2.5 V	500
		1.25 @ V _{GS} = 1.8 V	350
P-Channel	-20	1.2 @ V _{GS} = -4.5 V	-400
		1.6 @ V _{GS} = -2.5 V	-300
		2.7 @ V _{GS} = -1.8 V	-150

TrenchFET[®]
MOSFETs
1.8-V Rated



**ESD Protected
2000 V**

FEATURES

- Very Small Footprint
- High-Side Switching
- Low On-Resistance:
N-Channel, 0.7 Ω
P-Channel, 1.2 Ω
- Low Threshold: ±0.8 V (typ)
- Fast Switching Speed: 14 ns
- 1.8-V Operation
- Gate-Source ESD Protection

BENEFITS

- Ease in Driving Switches
- Low Offset (Error) Voltage
- Low-Voltage Operation
- High-Speed Circuits
- Low Battery Voltage Operation

APPLICATIONS

- Replace Digital Transistor, Level-Shifter
- Battery Operated Systems
- Power Supply Converter Circuits
- Load/Power Switching Cell Phones, Pagers

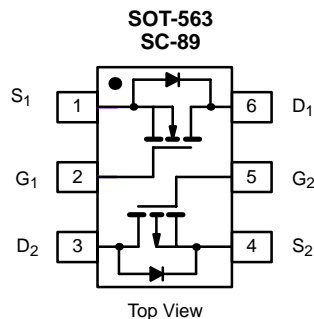

Marking Code: A

ABSOLUTE MAXIMUM RATINGS (T _A = 25 °C UNLESS OTHERWISE NOTED)							
Parameter	Symbol	N-Channel		P-Channel		Unit	
		5 secs	Steady State	5 secs	Steady State		
Drain-Source Voltage	V _{DS}	20		-20		V	
Gate-Source Voltage	V _{GS}	± 6					
Continuous Drain Current (T _J = 150 °C) ^a	I _D	T _A = 25 °C	515	485	-390	-370	mA
		T _A = 85 °C	370	350	-280	-265	
Pulsed Drain Current ^b	I _{DM}	650		-650			
Continuous Source Current (Diode Conduction) ^a	I _S	450	380	-450	-380		
Maximum Power Dissipation ^a	P _D	T _A = 25 °C	280	250	280	250	mW
		T _A = 85 °C	145	130	145	130	
Operating Junction and Storage Temperature Range	T _J , T _{stg}	-55 to 150				°C	
Gate-Source ESD Rating (HBM, Method 3015)	ESD	2000				V	

Notes

- Surface Mounted on FR4 Board.
- Pulse width limited by maximum junction temperature.



SPECIFICATIONS (T _J = 25 °C UNLESS OTHERWISE NOTED)							
Parameter	Symbol	Test Condition		Min	Typ	Max	Unit
Static							
Gate Threshold Voltage	V _{GS(th)}	V _{DS} = V _{GS} , I _D = 250 μA	N-Ch	0.45			V
		V _{DS} = V _{GS} , I _D = -250 μA	P-Ch	-0.45			
Gate-Body Leakage	I _{GSS}	V _{DS} = 0 V, V _{GS} = ±4.5 V	N-Ch		±0.5	±1.0	μA
			P-Ch		±1.0	±2.0	
Zero Gate Voltage Drain Current	I _{DSS}	V _{DS} = 16 V, V _{GS} = 0 V	N-Ch		0.3	100	nA
		V _{DS} = -16 V, V _{GS} = 0 V	P-Ch		-0.3	-100	
		V _{DS} = 16 V, V _{GS} = 0 V, T _J = 85 °C	N-Ch			5	μA
		V _{DS} = -16 V, V _{GS} = 0 V, T _J = 85 °C	P-Ch			-5	
On-State Drain Current ^a	I _{D(on)}	V _{DS} = 5 V, V _{GS} = 4.5 V	N-Ch	700			mA
		V _{DS} = -5 V, V _{GS} = -4.5 V	P-Ch	-700			
Drain-Source On-State Resistance ^a	r _{DS(on)}	V _{GS} = 4.5 V, I _D = 600 mA	N-Ch		0.41	0.70	Ω
		V _{GS} = -4.5 V, I _D = -350 mA	P-Ch		0.80	1.2	
		V _{GS} = 2.5 V, I _D = 500 mA	N-Ch		0.53	0.85	
		V _{GS} = -2.5 V, I _D = -300 mA	P-Ch		1.20	1.6	
		V _{GS} = 1.8 V, I _D = 350 mA	N-Ch		0.70	1.25	
		V _{GS} = -1.8 V, I _D = -150 mA	P-Ch		1.80	2.7	
Forward Transconductance ^a	g _{fs}	V _{DS} = 10 V, I _D = 400 mA	N-Ch		1.0		S
		V _{DS} = -10 V, I _D = -250 mA	P-Ch		0.4		
Diode Forward Voltage ^a	V _{SD}	I _S = 150 mA, V _{GS} = 0 V	N-Ch		0.8	1.2	V
		I _S = -150 mA, V _{GS} = 0 V	P-Ch		-0.8	-1.2	
Dynamic^b							
Total Gate Charge	Q _g	N-Channel V _{DS} = 10 V, V _{GS} = 4.5 V, I _D = 250 mA P-Channel V _{DS} = -10 V, V _{GS} = -4.5 V, I _D = -250 mA	N-Ch		750		pC
Gate-Source Charge	Q _{gs}		N-Ch		75		
			P-Ch		150		
Gate-Drain Charge	Q _{gd}	N-Ch		225			
		P-Ch		450			
Turn-On Time	t _{ON}	N-Channel V _{DD} = 10 V, R _L = 47 Ω I _D ≅ 200 mA, V _{GEN} = 4.5 V, R _G = 10 Ω	N-Ch		5		ns
			P-Ch		5		
Turn-Off Time	t _{OFF}	P-Channel V _{DD} = -10 V, R _L = 47 Ω I _D ≅ -200 A, V _{GEN} = -4.5 V, R _G = 10 Ω	N-Ch		25		
			P-Ch		35		

Notes

- a. Pulse test; pulse width ≤ 300 μs, duty cycle ≤ 2%.
b. Guaranteed by design, not subject to production testing.



TYPICAL CHARACTERISTICS (T_A = 25°C UNLESS NOTED) N-CHANNEL

Output Characteristics

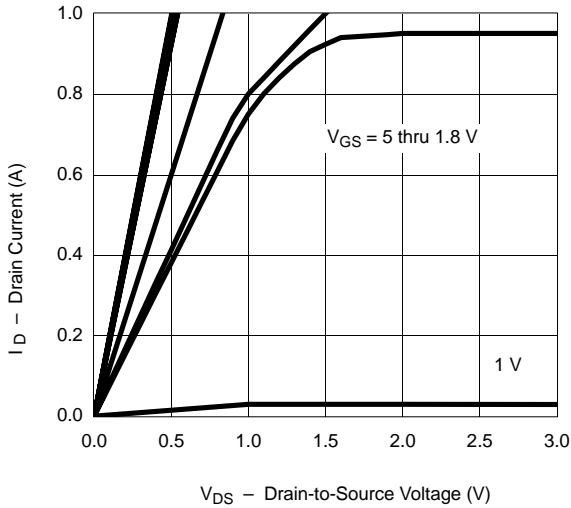

Transfer Characteristics

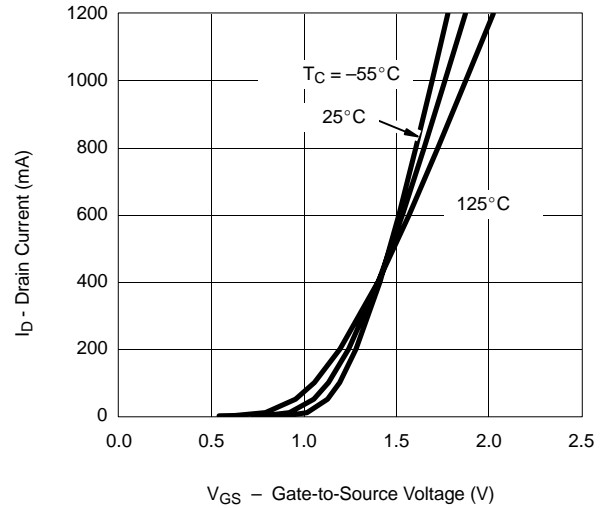

On-Resistance vs. Drain Current

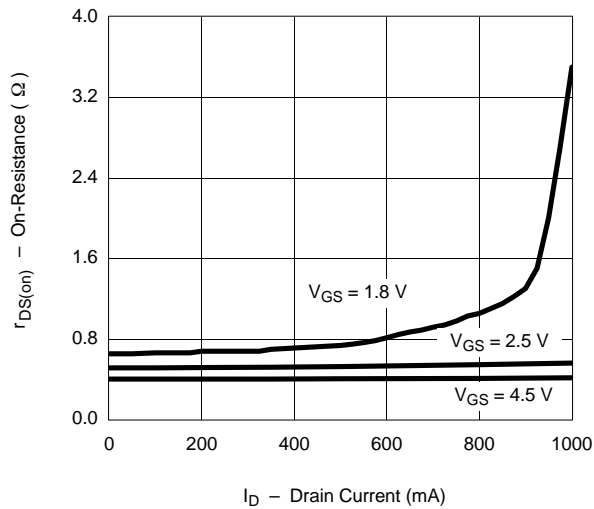

Capacitance

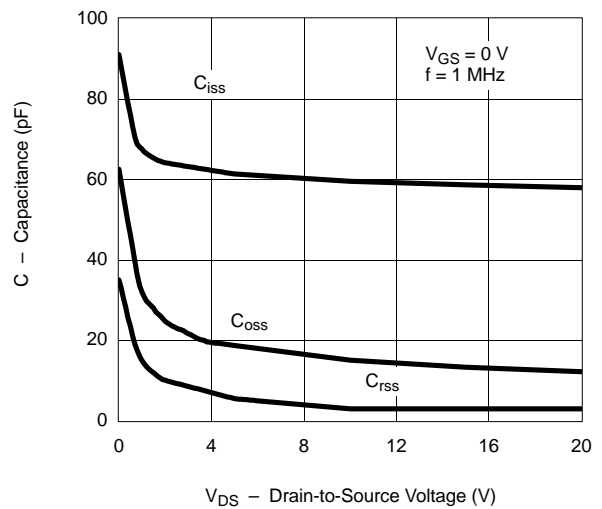

Gate Charge

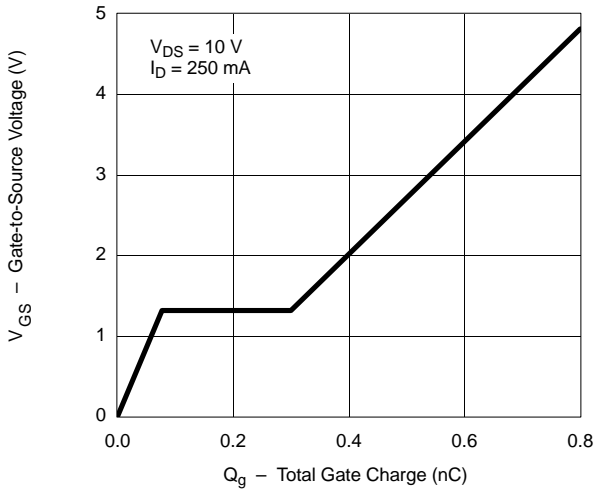

On-Resistance vs. Junction Temperature

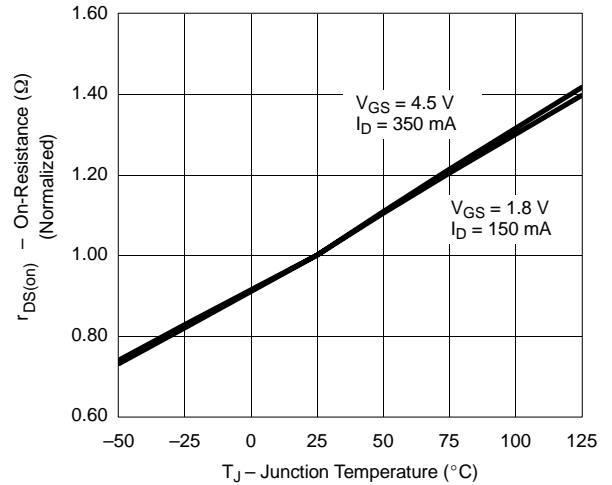



TYPICAL CHARACTERISTICS (T_A = 25°C UNLESS NOTED) N-CHANNEL

Source-Drain Diode Forward Voltage

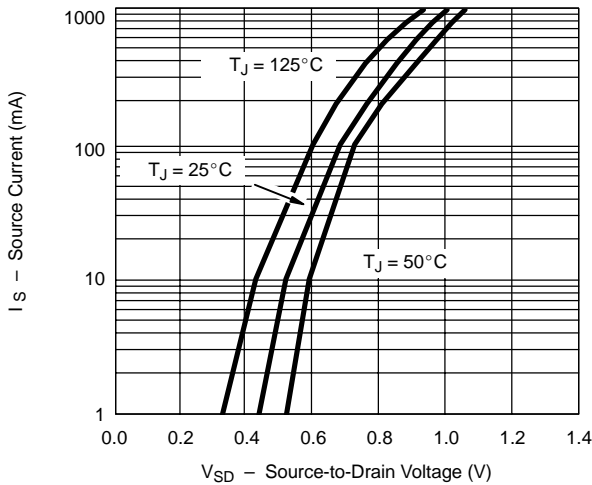

On-Resistance vs. Gate-to-Source Voltage

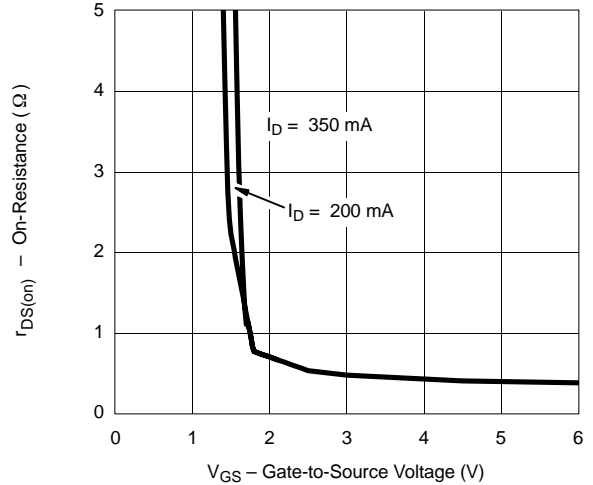

Threshold Voltage Variance vs. Temperature

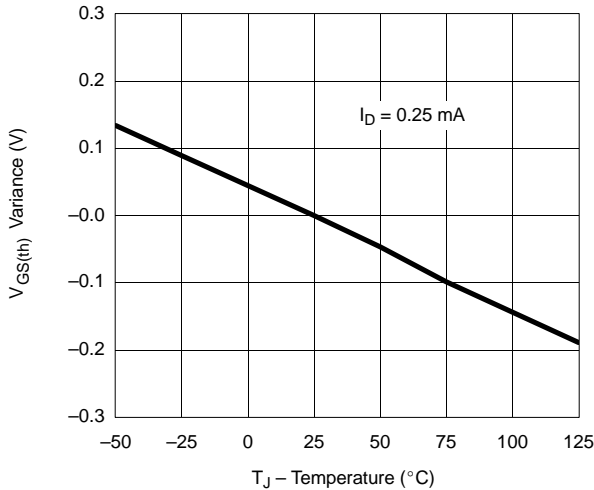

I_GSS vs. Temperature

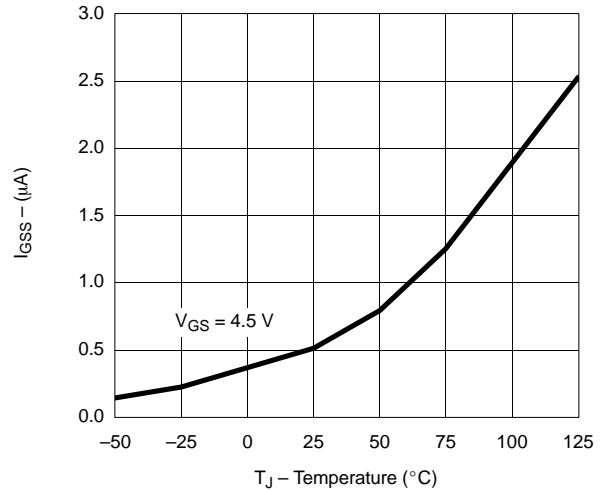

BV_GSS vs. Temperature

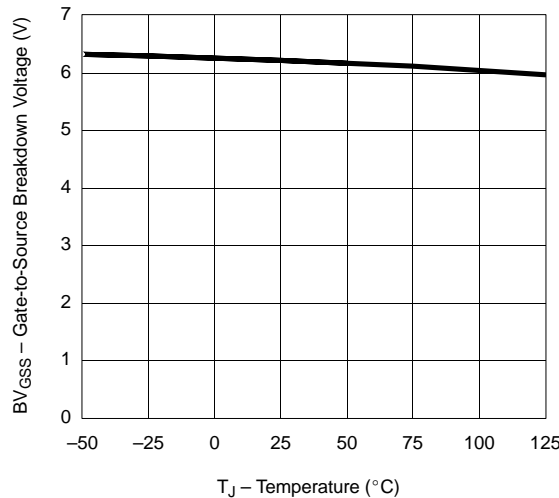



TYPICAL CHARACTERISTICS (T_A = 25°C UNLESS NOTED) P-CHANNEL

Output Characteristics

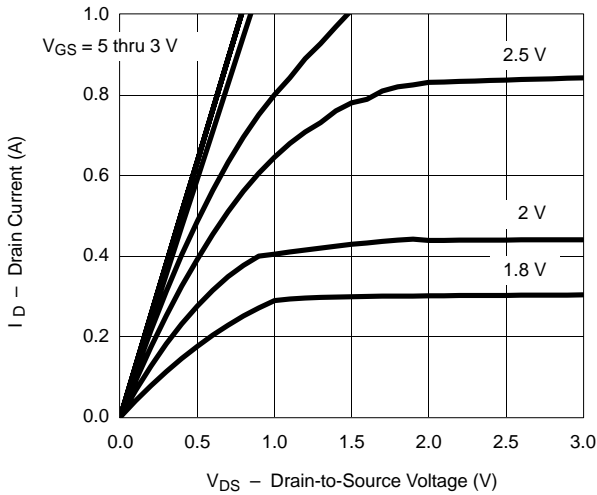

Transfer Characteristics

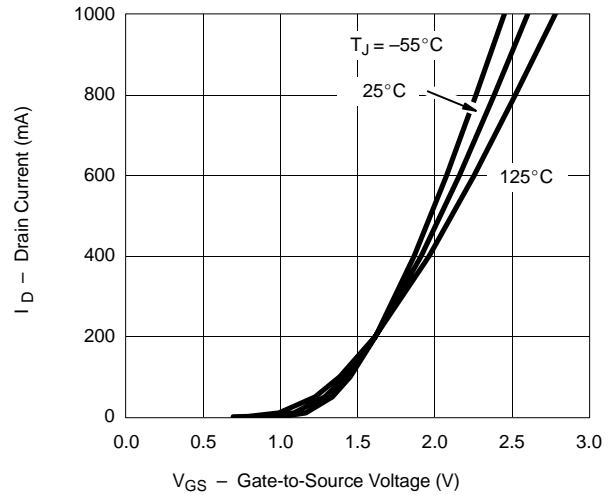

On-Resistance vs. Drain Current

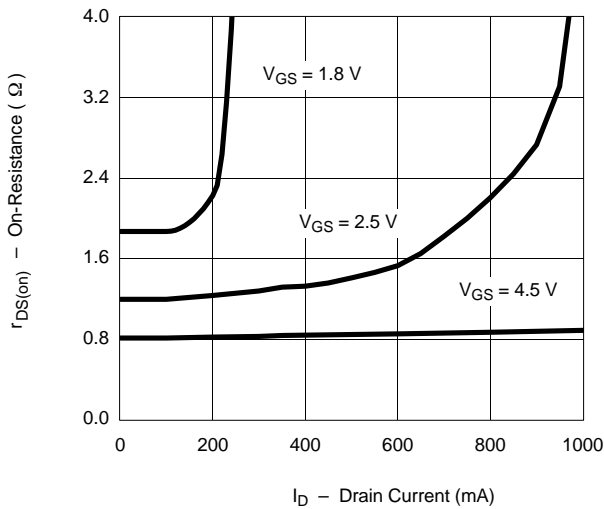

Capacitance

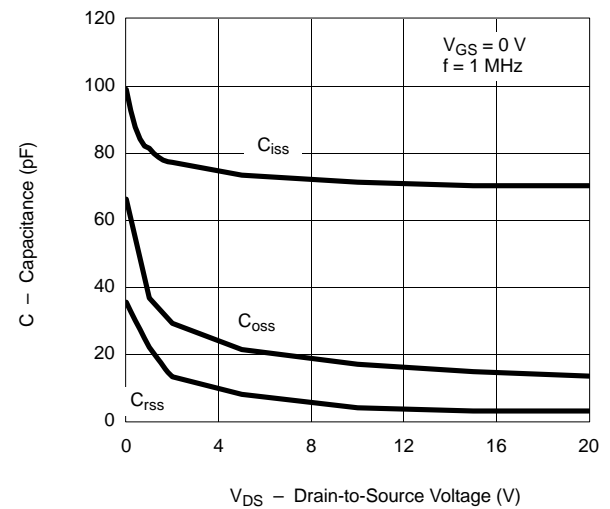

Gate Charge

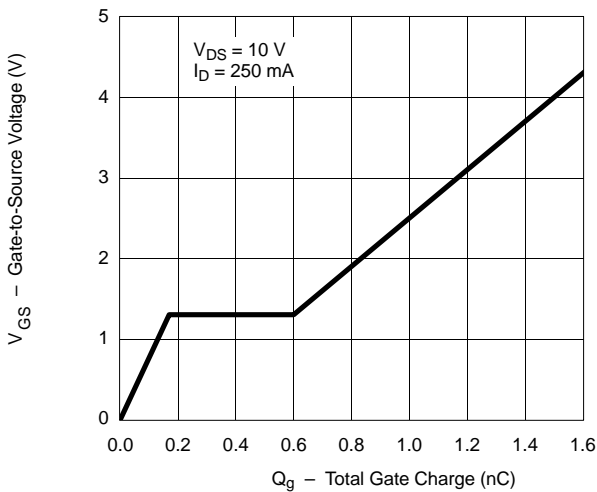

On-Resistance vs. Junction Temperature

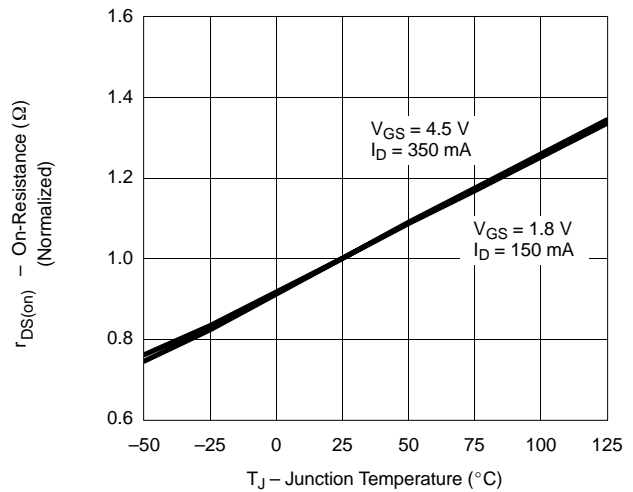

TYPICAL CHARACTERISTICS ($T_A = 25^\circ\text{C}$ UNLESS NOTED)

P-CHANNEL

Source-Drain Diode Forward Voltage

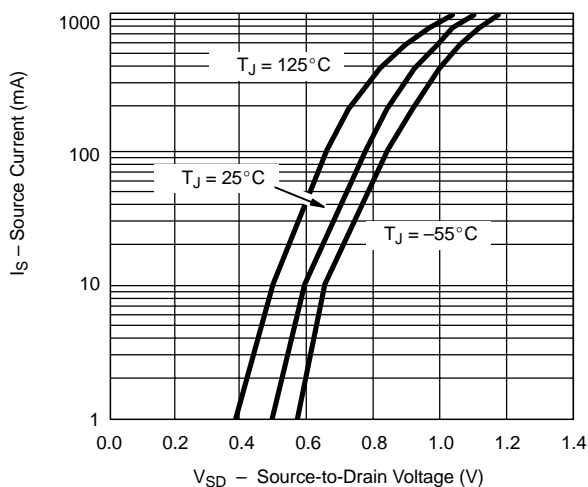

On-Resistance vs. Gate-to-Source Voltage

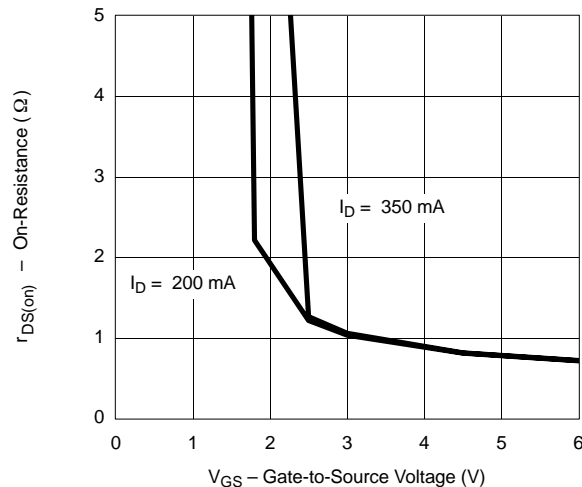

Threshold Voltage Variance vs. Temperature

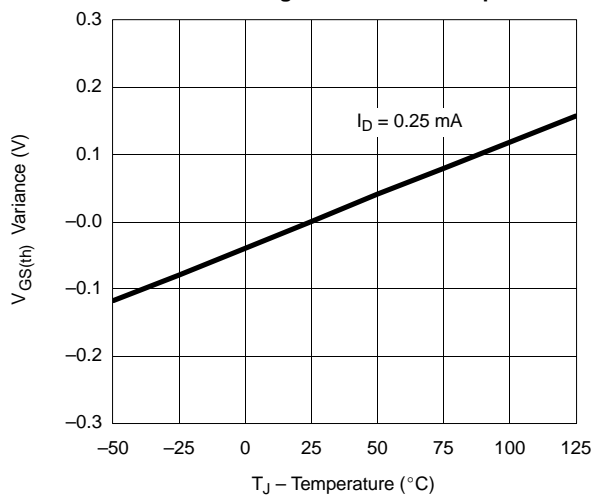

I_{GSS} vs. Temperature

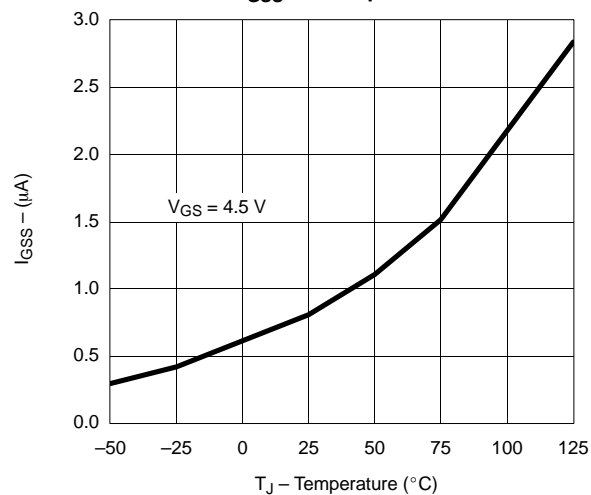

BV_{GSS} vs. Temperature

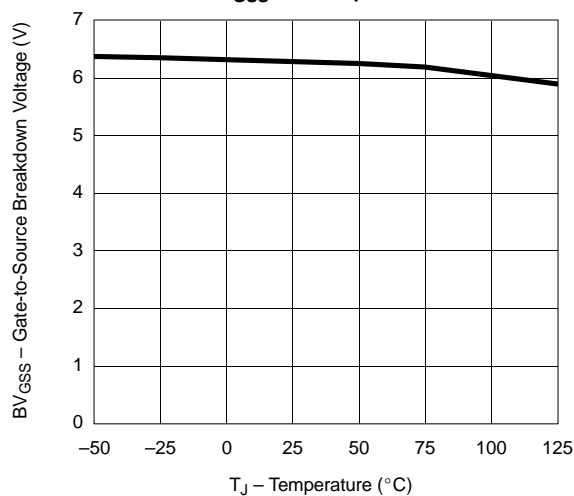



TYPICAL CHARACTERISTICS (T_A = 25°C UNLESS NOTED) N- OR P-CHANNEL

