

# FS16KM-9

HIGH-SPEED SWITCHING USE

## FS16KM-9



- V<sub>DSS</sub> ..... 450V
- r<sub>D(S)</sub> (ON) (MAX) ..... 0.45Ω
- I<sub>D</sub> ..... 16A
- V<sub>iso</sub> ..... 2000V

## OUTLINE DRAWING

Dimensions in mm

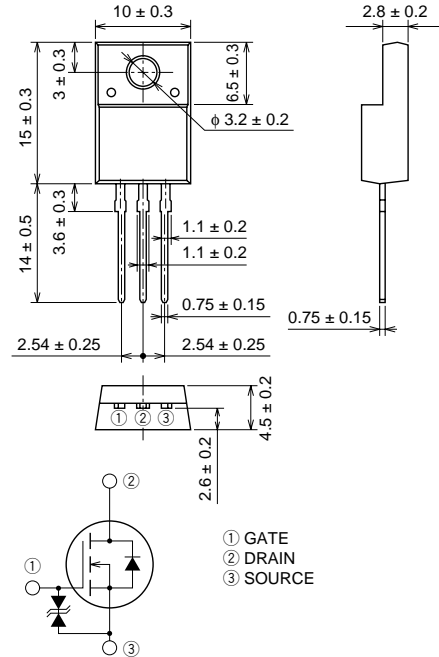

TO-220FN

## APPLICATION

SMPS, DC-DC Converter, battery charger, power supply of printer, copier, HDD, FDD, TV, VCR, personal computer etc.

## MAXIMUM RATINGS (T<sub>c</sub> = 25°C)

Symbol	Parameter	Conditions	Ratings	Unit
V <sub>DSS</sub>	Drain-source voltage	V <sub>GS</sub> = 0V	450	V
V <sub>GSS</sub>	Gate-source voltage	V <sub>DS</sub> = 0V	±30	V
I <sub>D</sub>	Drain current		16	A
I <sub>DM</sub>	Drain current (Pulsed)		48	A
P <sub>D</sub>	Maximum power dissipation		40	W
T <sub>ch</sub>	Channel temperature		-55 ~ +150	°C
T <sub>stg</sub>	Storage temperature		-55 ~ +150	°C
V <sub>iso</sub>	Isolation voltage	AC for 1minute, Terminal to case	2000	V <sub>rms</sub>
—	Weight	Typical value	2.0	g

# FS16KM-9

## HIGH-SPEED SWITCHING USE

### ELECTRICAL CHARACTERISTICS (Tch = 25°C)

Symbol	Parameter	Test conditions	Limits			Unit
			Min.	Typ.	Max.	
V (BR) DSS	Drain-source breakdown voltage	Id = 1mA, VGS = 0V	450	—	—	V
V (BR) GSS	Gate-source breakdown voltage	IG = ±100μA, VDS = 0V	±30	—	—	V
IGSS	Gate-source leakage current	VGS = ±25V, VDS = 0V	—	—	±10	μA
IDSS	Drain-source leakage current	VDS = 450V, VGS = 0V	—	—	1	mA
VGS (th)	Gate-source threshold voltage	Id = 1mA, VDS = 10V	2	3	4	V
rDS (ON)	Drain-source on-state resistance	Id = 8A, VGS = 10V	—	0.35	0.45	Ω
VDS (ON)	Drain-source on-state voltage	Id = 8A, VGS = 10V	—	2.80	3.60	V
yfs	Forward transfer admittance	Id = 8A, VDS = 10V	6.0	8.0	—	S
Ciss	Input capacitance	VDS = 25V, VGS = 0V, f = 1MHz	—	1700	—	pF
Coss	Output capacitance		—	230	—	pF
Crss	Reverse transfer capacitance		—	40	—	pF
td (on)	Turn-on delay time		—	30	—	ns
tr	Rise time	VDD = 200V, Id = 8A, VGS = 10V, RGEN = RGS = 50Ω	—	50	—	ns
td (off)	Turn-off delay time		—	170	—	ns
tf	Fall time		—	60	—	ns
VSD	Source-drain voltage	IS = 8A, VGS = 0V	—	1.5	2.0	V
Rth (ch-c)	Thermal resistance	Channel to case	—	—	3.13	°C/W

### PERFORMANCE CURVES

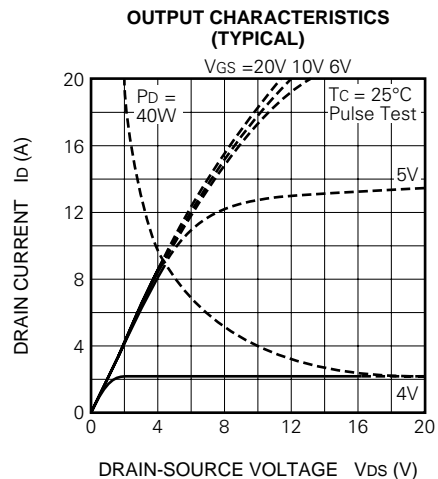
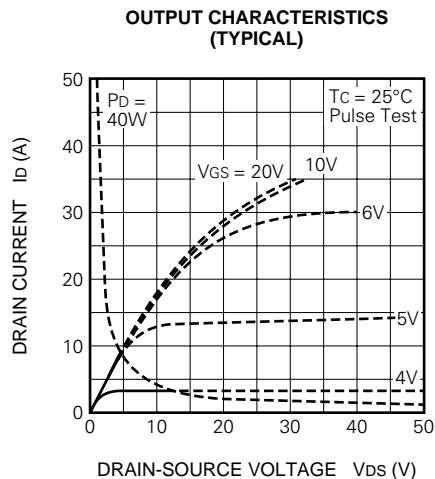
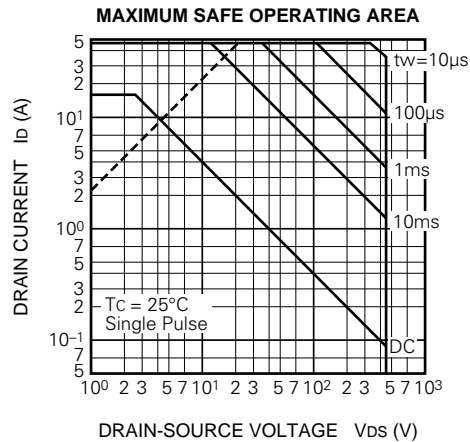
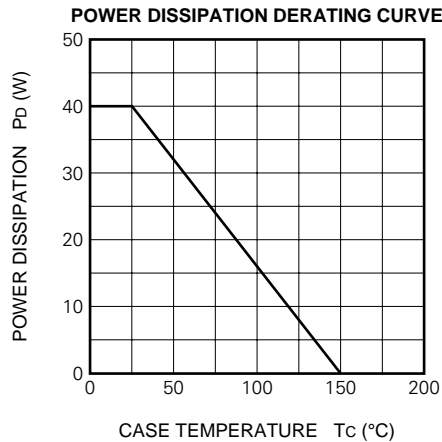

ON-STATE VOLTAGE VS. GATE-SOURCE VOLTAGE (TYPICAL)

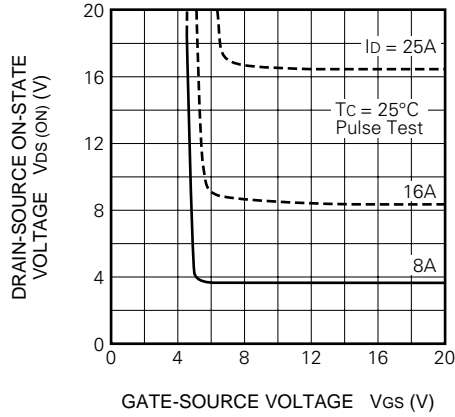

ON-STATE RESISTANCE VS. DRAIN CURRENT (TYPICAL)

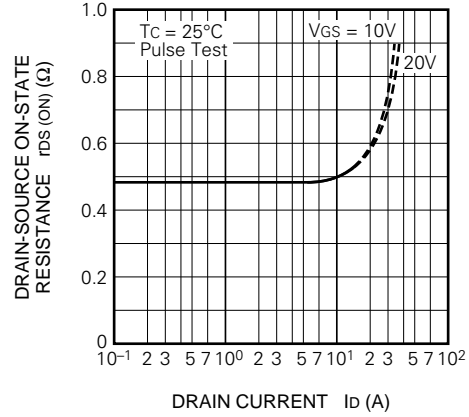

TRANSFER CHARACTERISTICS (TYPICAL)

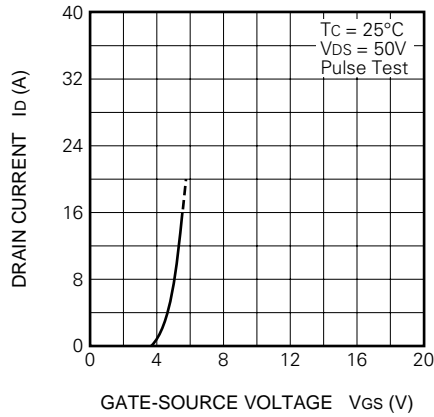

FORWARD TRANSFER ADMITTANCE VS. DRAIN CURRENT (TYPICAL)

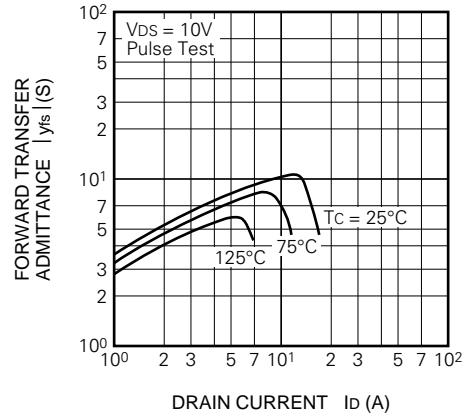

CAPACITANCE VS. DRAIN-SOURCE VOLTAGE (TYPICAL)

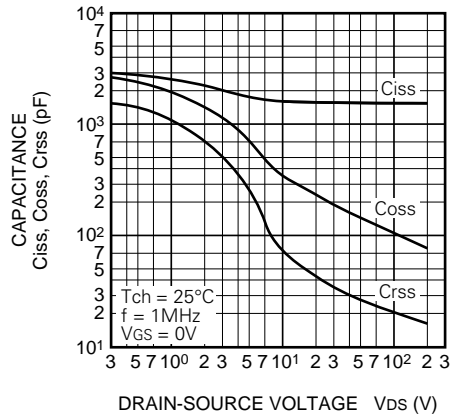

SWITCHING CHARACTERISTICS (TYPICAL)

