

FS14SM-9

HIGH-SPEED SWITCHING USE

FS14SM-9



- V_{DSS} 450V
- r_{DS (ON)} (MAX) 0.52Ω
- I_D 14A

OUTLINE DRAWING

Dimensions in mm

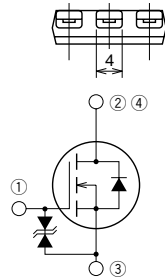
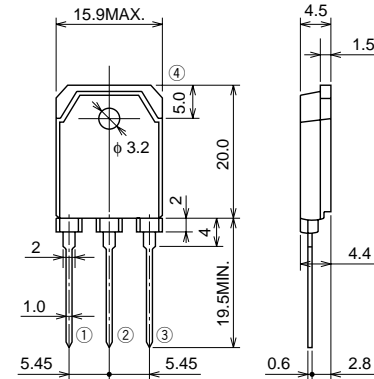

- ① GATE
- ② DRAIN
- ③ SOURCE
- ④ DRAIN

TO-3P

APPLICATION

SMPS, DC-DC Converter, battery charger, power supply of printer, copier, HDD, FDD, TV, VCR, personal computer etc.

MAXIMUM RATINGS (T_c = 25°C)

Symbol	Parameter	Conditions	Ratings	Unit
V _{DSS}	Drain-source voltage	V _{GS} = 0V	450	V
V _{GSS}	Gate-source voltage	V _{DS} = 0V	±30	V
I _D	Drain current		14	A
I _{DM}	Drain current (Pulsed)		42	A
P _D	Maximum power dissipation		150	W
T _{ch}	Channel temperature		-55 ~ +150	°C
T _{stg}	Storage temperature		-55 ~ +150	°C
—	Weight	Typical value	4.8	g

ELECTRICAL CHARACTERISTICS (Tch = 25°C)

Symbol	Parameter	Test conditions	Limits			Unit
			Min.	Typ.	Max.	
V (BR) DSS	Drain-source breakdown voltage	Id = 1mA, VGS = 0V	450	—	—	V
V (BR) GSS	Gate-source breakdown voltage	IG = ±100μA, VDS = 0V	±30	—	—	V
IGSS	Gate-source leakage current	VGS = ±25V, VDS = 0V	—	—	±10	μA
IDSS	Drain-source leakage current	VDS = 450V, VGS = 0V	—	—	1	mA
VGS (th)	Gate-source threshold voltage	Id = 1mA, VDS = 10V	2	3	4	V
rDS (ON)	Drain-source on-state resistance	Id = 7A, VGS = 10V	—	0.40	0.52	Ω
VDS (ON)	Drain-source on-state voltage	Id = 7A, VGS = 10V	—	2.8	3.6	V
yfs	Forward transfer admittance	Id = 7A, VDS = 10V	4.5	7.0	—	S
Ciss	Input capacitance	VDS = 25V, VGS = 0V, f = 1MHz	—	1500	—	pF
Coss	Output capacitance		—	180	—	pF
Crss	Reverse transfer capacitance		—	30	—	pF
td (on)	Turn-on delay time		—	30	—	ns
tr	Rise time	VDD = 200V, Id = 7A, VGS = 10V, RGEN = RGS = 50Ω	—	50	—	ns
td (off)	Turn-off delay time		—	130	—	ns
tf	Fall time		—	50	—	ns
VSD	Source-drain voltage	Is = 7A, VGS = 0V	—	1.5	2.0	V
Rth (ch-c)	Thermal resistance	Channel to case	—	—	0.83	°C/W

PERFORMANCE CURVES

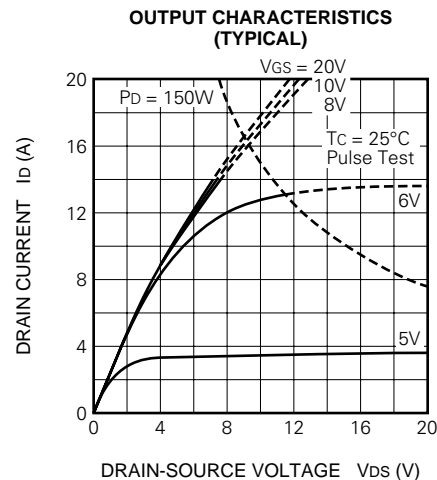
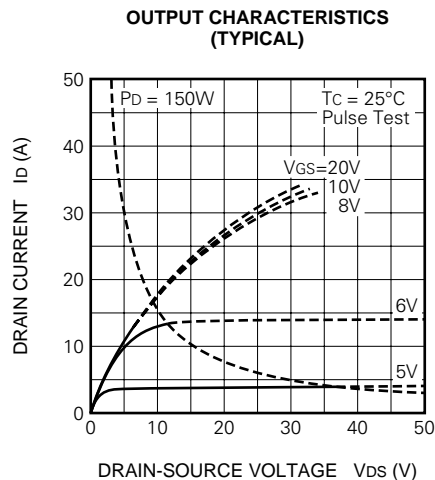
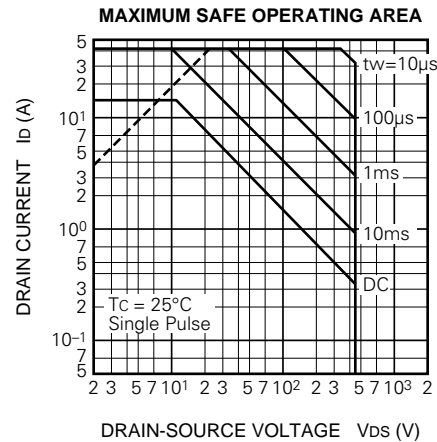
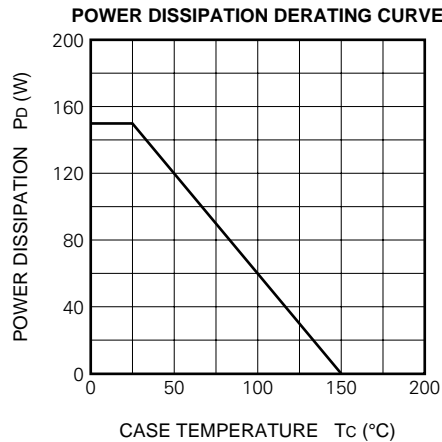

ON-STATE VOLTAGE VS. GATE-SOURCE VOLTAGE (TYPICAL)

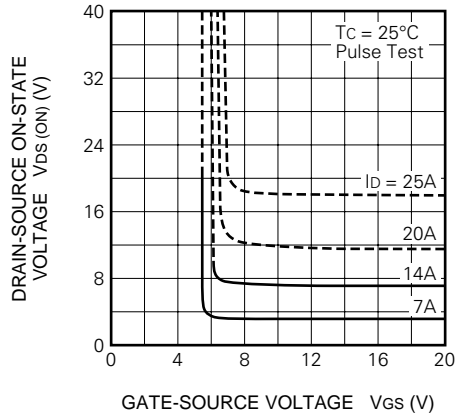

ON-STATE RESISTANCE VS. DRAIN CURRENT (TYPICAL)

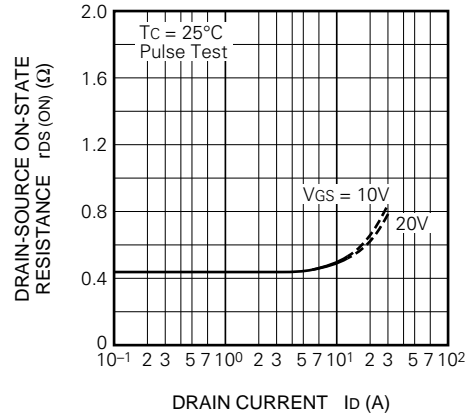

TRANSFER CHARACTERISTICS (TYPICAL)

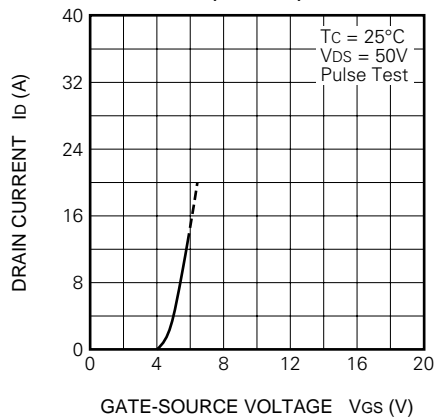

FORWARD TRANSFER ADMITTANCE VS. DRAIN CURRENT (TYPICAL)

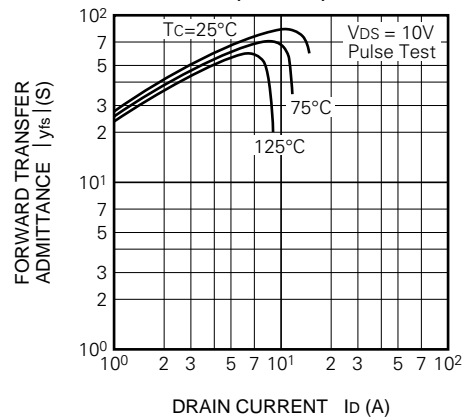

CAPACITANCE VS. DRAIN-SOURCE VOLTAGE (TYPICAL)

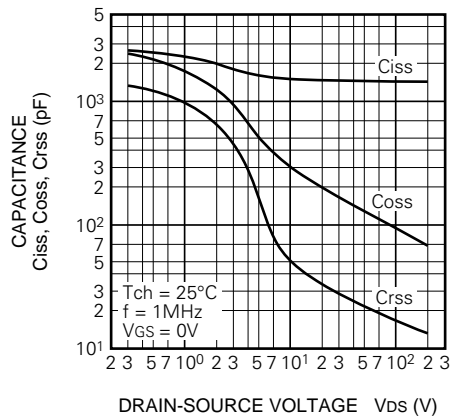

SWITCHING CHARACTERISTICS (TYPICAL)

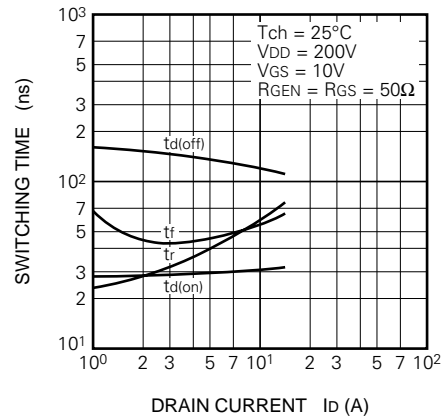

GATE-SOURCE VOLTAGE VS. GATE CHARGE (TYPICAL)

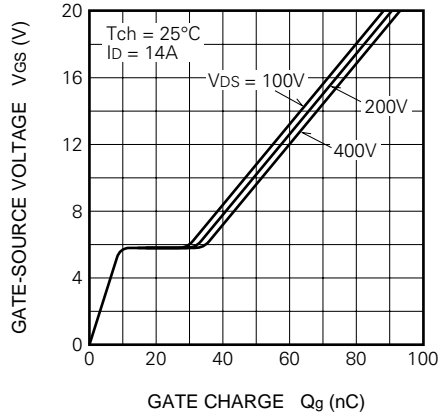

SOURCE-DRAIN DIODE FORWARD CHARACTERISTICS (TYPICAL)

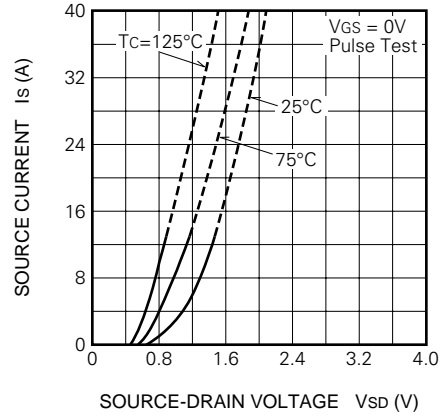

ON-STATE RESISTANCE VS. CHANNEL TEMPERATURE (TYPICAL)

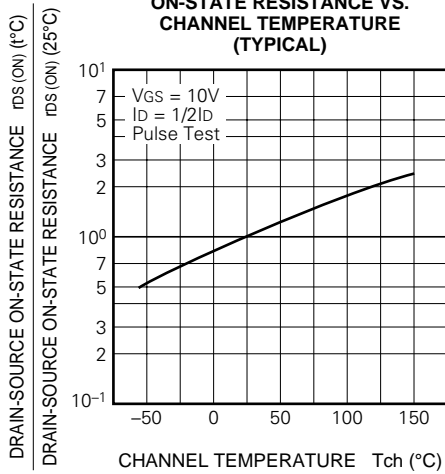

THRESHOLD VOLTAGE VS. CHANNEL TEMPERATURE (TYPICAL)

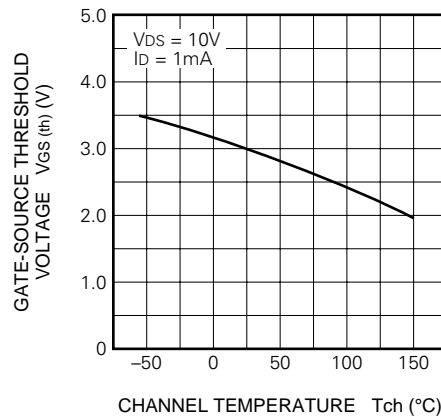

BREAKDOWN VOLTAGE VS. CHANNEL TEMPERATURE (TYPICAL)

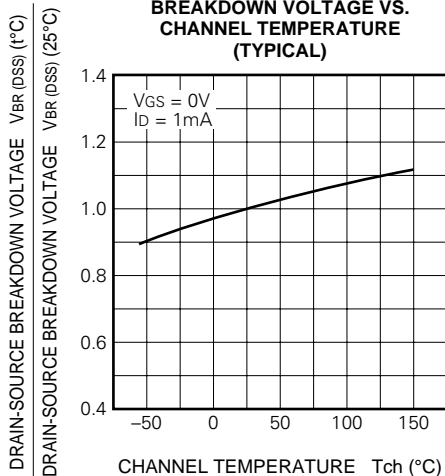

TRANSIENT THERMAL IMPEDANCE CHARACTERISTICS

