

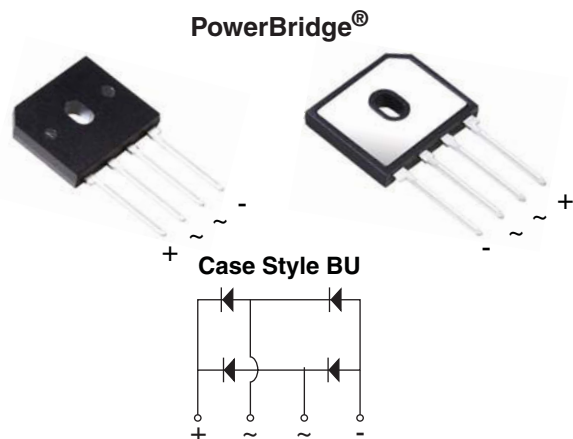

Enhanced PowerBridge[®] Rectifiers



* Tested to UL standard for safety electrically isolated semiconductor devices. UL 1557 4th edition.
Dielectric tested to maximum case, storage and junction temperature to 150 °C to withstand 1500 V.
Epoxy meets UL 94 V-0 flammability rating.

PRIMARY CHARACTERISTICS	
$I_{F(AV)}$	20 A
V_{RRM}	600 V, 800 V, 1000 V
I_{FSM}	240 A
I_R	5 μ A
V_F at $I_F = 10$ A	0.85 V
T_J max.	150 °C

MAXIMUM RATINGS ($T_A = 25$ °C unless otherwise noted)					
PARAMETER	SYMBOL	BU2006	BU2008	BU2010	UNIT
Maximum repetitive peak reverse voltage	V_{RRM}	600	800	1000	V
Average rectified forward current (Fig. 1, 2)	I_O		20 3.5		A
Non-repetitive peak forward surge current 8.3 ms single sine-wave, $T_J = 25$ °C	I_{FSM}		240		A
Rating for fusing ($t < 8.3$ ms) $T_J = 25$ °C	I^2t		239		A ² s
Operating junction and storage temperature range	T_J, T_{STG}		- 55 to + 150		°C

Notes

(1) With 60 W air cooled heatsink

(2) Without heatsink, free air

FEATURES

- UL recognition file number E309391 (QQX2) UL 1557 (see *)
- Thin single in-line package
- Available for BU-5S lead forming option (part number with "5S" suffix, e.g. BU20065S)
- Superior thermal conductivity
- Solder dip 275 °C max. 10 s, per JESD 22-B106
- Compliant to RoHS Directive 2002/95/EC and in accordance to WEEE 2002/96/EC
- **Halogen-free according to IEC 61249-2-21 definition**



RoHS
COMPLIANT
HALOGEN
FREE

TYPICAL APPLICATIONS

General purpose use in AC/DC bridge full wave rectification for switching power supply, home appliances and white-goods applications.

MECHANICAL DATA

Case: BU

Molding compound meets UL 94 V-0 flammability rating

Base P/N-M3 - halogen-free, RoHS compliant, and commercial grade

Terminals: Matte tin plated leads, solderable per J-STD-002 and JESD 22-B102

M3 suffix meets JESD 201 class 1A whisker test

Polarity: As marked on body

Mounting Torque: 10 cm-kg (8.8 inches-lbs) max.

Recommended Torque: 5.7 cm-kg (5 inches-lbs)

ELECTRICAL CHARACTERISTICS (T _A = 25 °C unless otherwise noted)						
PARAMETER	TEST CONDITIONS		SYMBOL	TYP.	MAX.	UNIT
Maximum instantaneous forward voltage per diode ⁽¹⁾	I _F = 10 A	T _A = 25 °C T _A = 125 °C	V _F	0.95 0.85	1.05 0.95	V
Maximum reverse current per diode	rated V _R	T _A = 25 °C T _A = 125 °C	I _R	- 110	5.0 350	μA
Typical junction capacitance per diode	4.0 V, 1 MHz		C _J	95	-	pF

Note

⁽¹⁾ Pulse test: 300 μs pulse width, 1 % duty cycle

THERMAL CHARACTERISTICS (T _A = 25 °C unless otherwise noted)					
PARAMETER	SYMBOL	BU2006	BU2008	BU2010	UNIT
Typical thermal resistance	R _{θJC} ⁽¹⁾	2.4			°C/W
	R _{θJA} ⁽²⁾	20			

Notes

⁽¹⁾ With 60 W air cooled heatsink

⁽²⁾ Without heatsink, free air

ORDERING INFORMATION (Example)				
PREFERRED P/N	UNIT WEIGHT (g)	PREFERRED PACKAGE CODE	BASE QUANTITY	DELIVERY MODE
BU2006-M3/45	4.76	45	20	Tube
BU2006-M3/51	4.76	51	250	Paper tray
BU2006S-M3/45	4.76	45	20	Tube

RATINGS AND CHARACTERISTICS CURVES

(T_A = 25 °C unless otherwise noted)

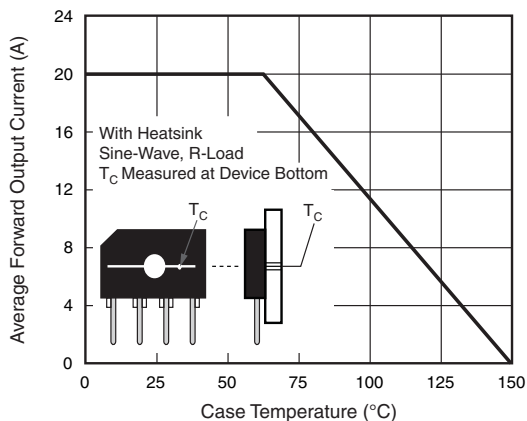

Figure 1. Derating Curve Output Rectified Current

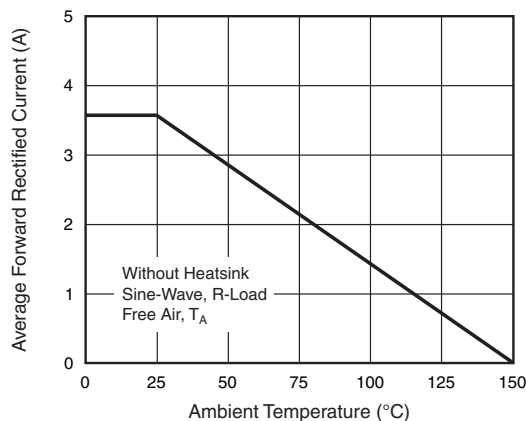

Figure 2. Forward Current Derating Curve

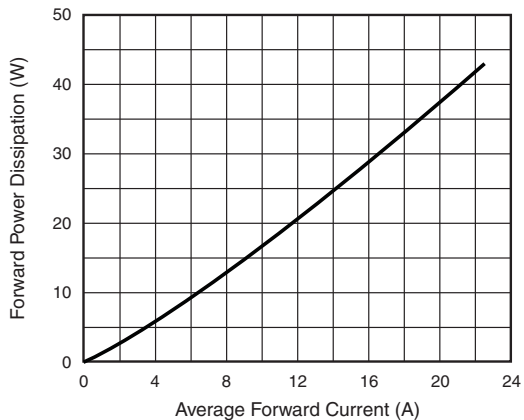

Figure 3. Forward Power Dissipation

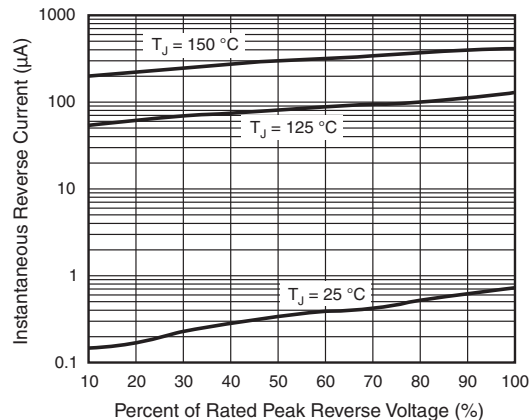

Figure 5. Typical Reverse Characteristics Per Diode

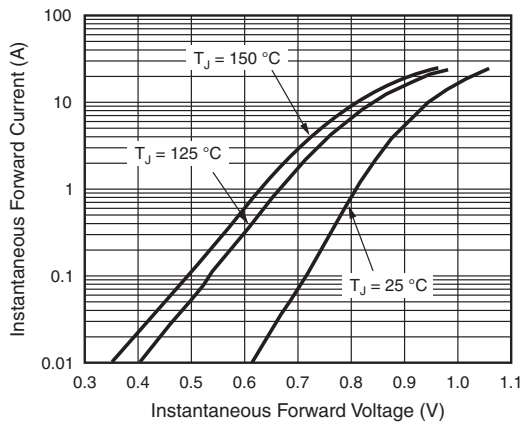

Figure 4. Typical Forward Characteristics Per Diode

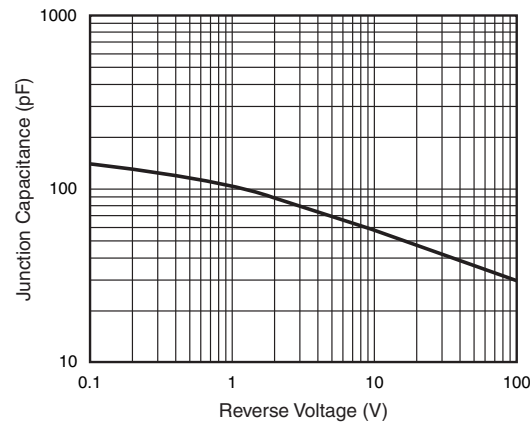

Figure 6. Typical Junction Capacitance Per Diode

BU2006 thru BU2010

Vishay General Semiconductor



PACKAGE OUTLINE DIMENSIONS in inches (millimeters)

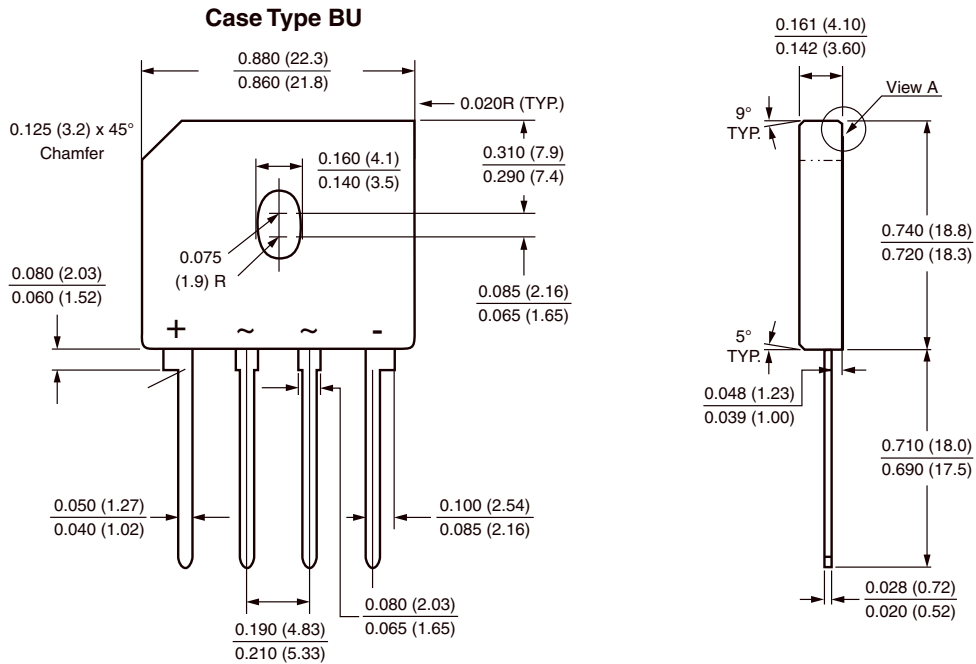

Polarity shown on front side of case, positive lead beveled corner

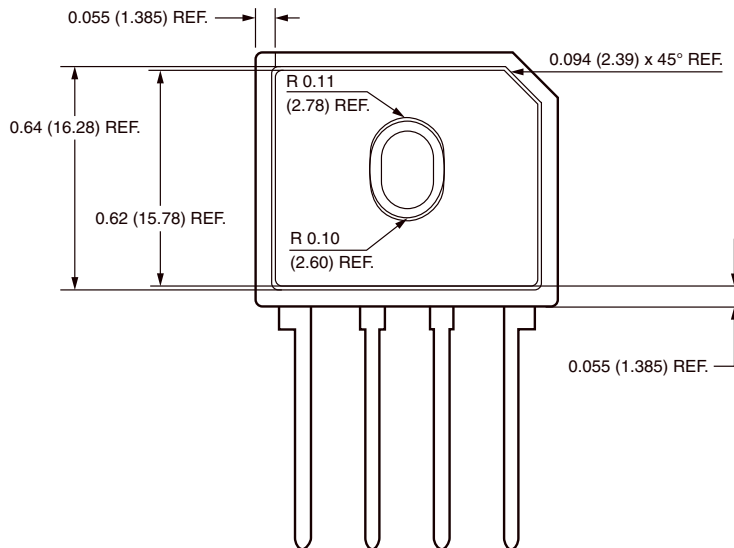

FORMING SPECIFICATION: BU-5S in inches (millimeters)

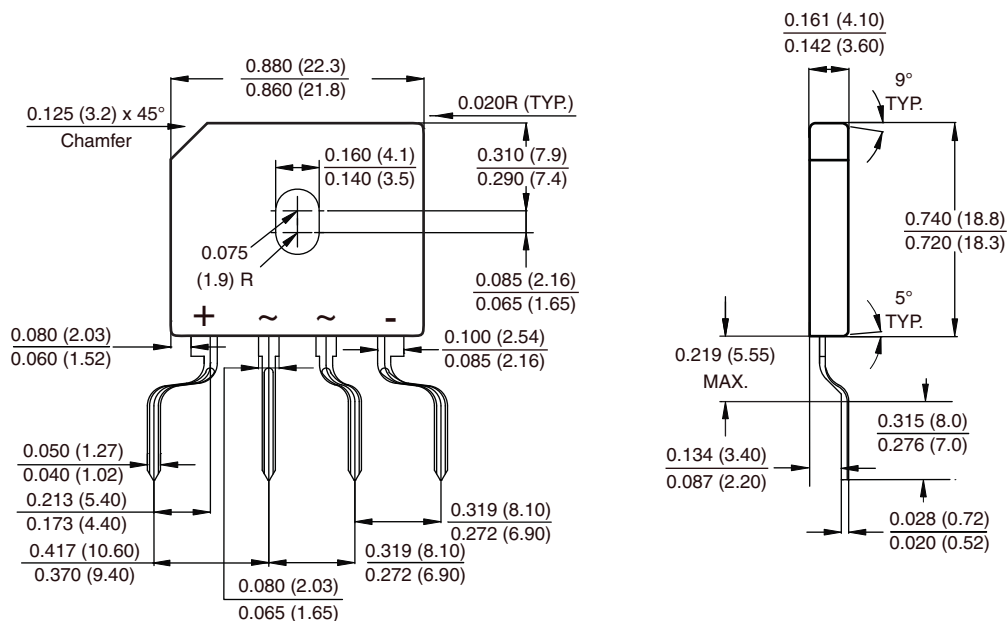

APPLICATION NOTE

- (1) Device UL approved for safety use dielectric strength of 1500 V.
- (2) If device is mounted in Floating Ground (F. G.) application, insulator is recommended to use to meet safety requirement.
- (3) Heat sink shape recommendation:

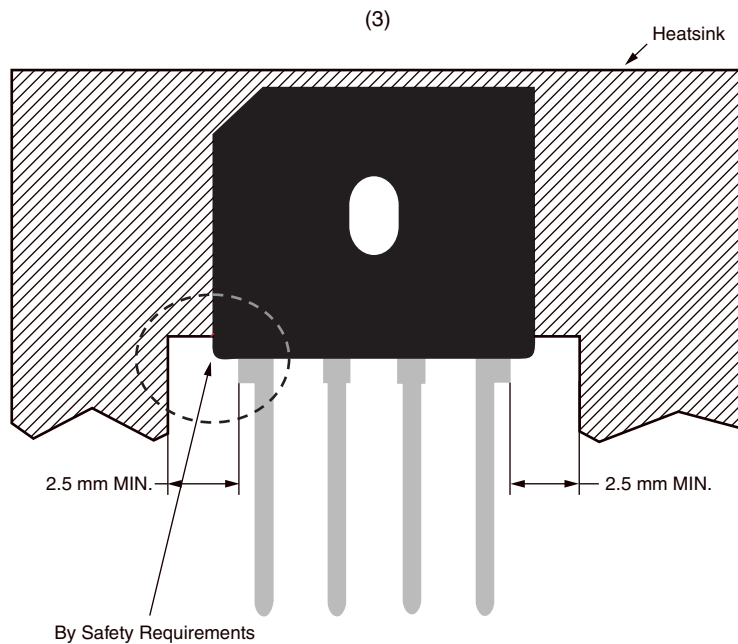



Disclaimer

ALL PRODUCT, PRODUCT SPECIFICATIONS AND DATA ARE SUBJECT TO CHANGE WITHOUT NOTICE TO IMPROVE RELIABILITY, FUNCTION OR DESIGN OR OTHERWISE.

Vishay Intertechnology, Inc., its affiliates, agents, and employees, and all persons acting on its or their behalf (collectively, "Vishay"), disclaim any and all liability for any errors, inaccuracies or incompleteness contained in any datasheet or in any other disclosure relating to any product.

Vishay makes no warranty, representation or guarantee regarding the suitability of the products for any particular purpose or the continuing production of any product. To the maximum extent permitted by applicable law, Vishay disclaims (i) any and all liability arising out of the application or use of any product, (ii) any and all liability, including without limitation special, consequential or incidental damages, and (iii) any and all implied warranties, including warranties of fitness for particular purpose, non-infringement and merchantability.

Statements regarding the suitability of products for certain types of applications are based on Vishay's knowledge of typical requirements that are often placed on Vishay products in generic applications. Such statements are not binding statements about the suitability of products for a particular application. It is the customer's responsibility to validate that a particular product with the properties described in the product specification is suitable for use in a particular application. Parameters provided in datasheets and/or specifications may vary in different applications and performance may vary over time. All operating parameters, including typical parameters, must be validated for each customer application by the customer's technical experts. Product specifications do not expand or otherwise modify Vishay's terms and conditions of purchase, including but not limited to the warranty expressed therein.

Except as expressly indicated in writing, Vishay products are not designed for use in medical, life-saving, or life-sustaining applications or for any other application in which the failure of the Vishay product could result in personal injury or death. Customers using or selling Vishay products not expressly indicated for use in such applications do so at their own risk and agree to fully indemnify and hold Vishay and its distributors harmless from and against any and all claims, liabilities, expenses and damages arising or resulting in connection with such use or sale, including attorneys fees, even if such claim alleges that Vishay or its distributor was negligent regarding the design or manufacture of the part. Please contact authorized Vishay personnel to obtain written terms and conditions regarding products designed for such applications.

No license, express or implied, by estoppel or otherwise, to any intellectual property rights is granted by this document or by any conduct of Vishay. Product names and markings noted herein may be trademarks of their respective owners.