

### IGBT MODULE ( L series)

#### ■ Features

- High Speed Switching
- Low Saturation Voltage
- Voltage Drive
- Isolated Package

#### ■ Applications

- Ideal for Chopper Application
- AC and DC Servo Drive Supply
- Uninterruptible Power Supply
- Industrial Machines, such as Welding Machines

#### ■ Maximum Ratings and Characteristics

##### ● Absolute Maximum Ratings

Items	Symbols	Ratings	Units
Collector-Emmitter Voltage	$V_{CES}$	600	V
Gate-Emmitter Voltage	$V_{GES}$	$\pm 20$	V
Collector Current	Continuous	$I_C$	50
	1ms	$I_{C,pulse}$	100
Max. Power Dissipation	$P_C$	200	W
Operating Temperature	$T_J$	+150	$^{\circ}C$
Storage Temperature	$T_{stg}$	-40 to +125	$^{\circ}C$
Isolation Voltage	AC, 1min.	$V_{is}$	2500
Screw Torque	Mounting *1	1.7	N•m
	Terminals *1	1.7	

##### ● Electrical Characteristics ( $T_J=25^{\circ}C$ unless otherwise specified)

Items	Symbols	Test Conditions	Min.	Typ.	Max.	Units
Zero Gate Voltage Collector Current	$I_{CES}$	$V_{GE}=0V$ $V_{CE}=600V$ $T_C=25^{\circ}C$			1.0	mA
Gate-Emmitter Leakage Current	$I_{GES}$	$V_{CE}=0V$ $V_{GE}=\pm 20V$			100	nA
Gate-Emmitter Threshold Voltage	$V_{GE(th)}$	$V_{CE}=20V$ $I_C=50mA$	3.0		6.0	V
Collector-Emmitter Saturation Voltage	$V_{CE(sat)}$	$V_{GE}=15V$ $I_C=50A$		2.7	3.5	V
Input Capacitance	$C_{ies}$	$V_{GE}=0V$		4750		pF
Output Capacitance	$C_{oes}$	$V_{CE}=10V$		-		
Reverse Transfer Capacitance	$C_{res}$	$f=1MHz$		-		
Turn-on Time	$t_{on}$	$V_{CC}=300V$		0.4	0.8	$\mu s$
	$t_r$	$I_C=50A$		0.3	0.6	
Turn-off Time	$t_{off}$	$V_{GE}=\pm 15V$		0.6	1.0	
	$t_f$	$R_G=51\Omega$		0.2	0.35	

$t_{on}, t_r$ : Resistive Load       $t_{off}, t_f$ : Inductive Load

##### ● Thermal Characteristics

Items	Symbols	Test Conditions	Min.	Typ.	Max.	Units
Thermal Resistance	$R_{th(j-c)}$	IGBT			0.625	$^{\circ}C/W$
	$R_{th(c-f)}$	With Thermal compound		0.03		

#### ■ Outline Drawings

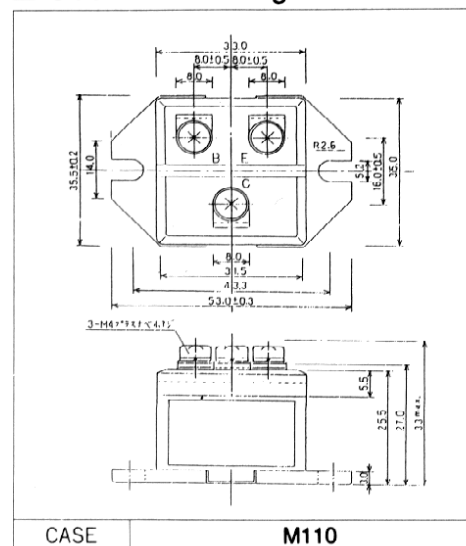

#### ■ Equivalent Circuit Schematic

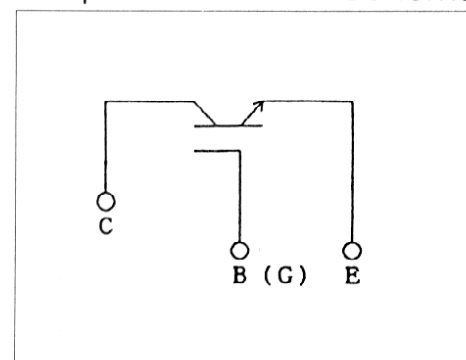

\*1 Recommendable Value 1.3 ~ 1.7 N•m (M4)

■ Characteristics

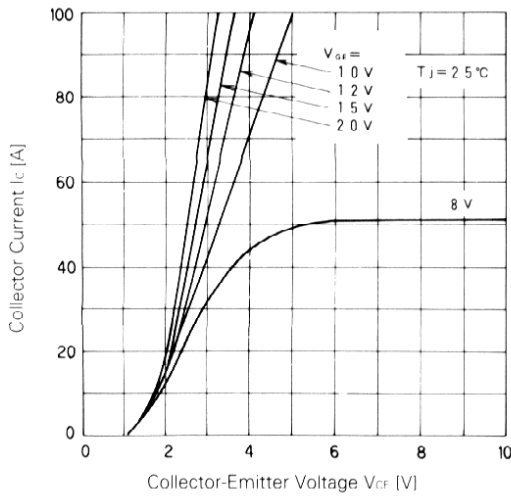

Collector Current vs. Collector-Emitter Voltage

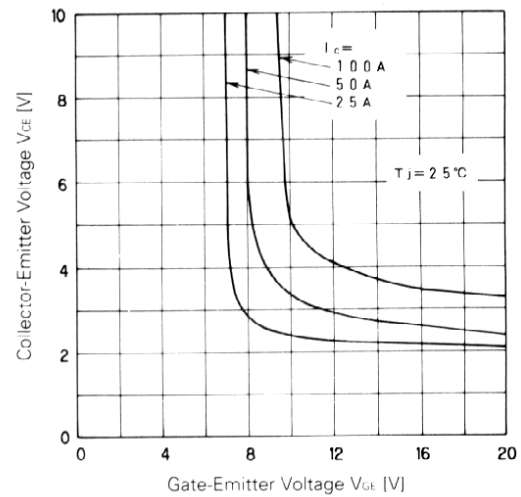

Collector-Emitter Voltage vs. Gate-Emitter Voltage

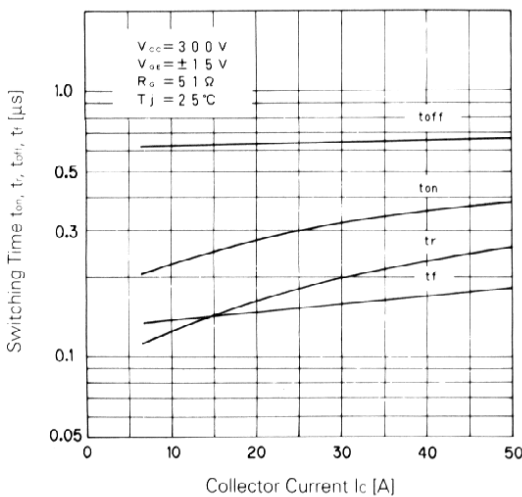

Switching Time

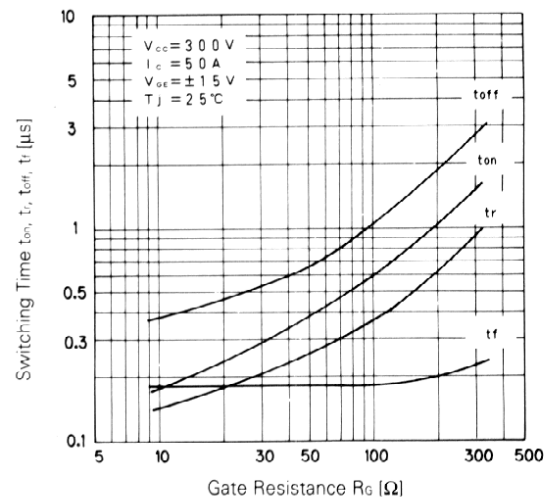

Switching Time-Gate Resistance

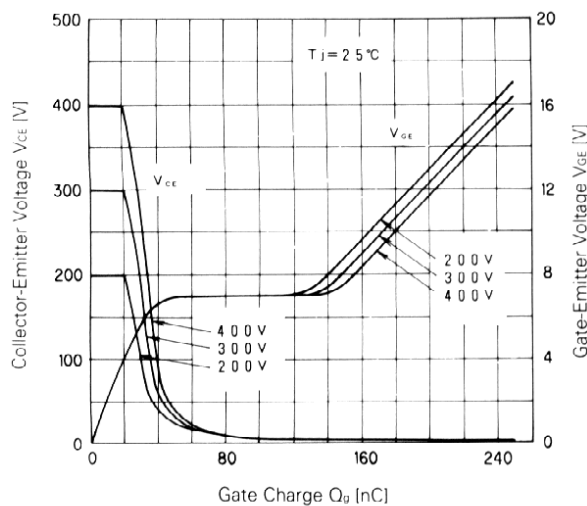

Dynamic Input Characteristic

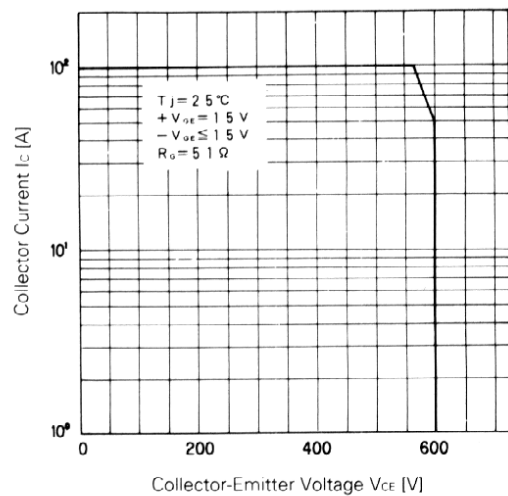

Reverse Biased Safe Operating Area

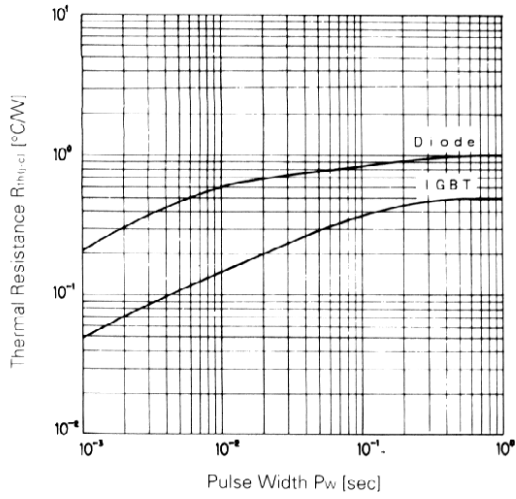

Transient Thermal Resistance

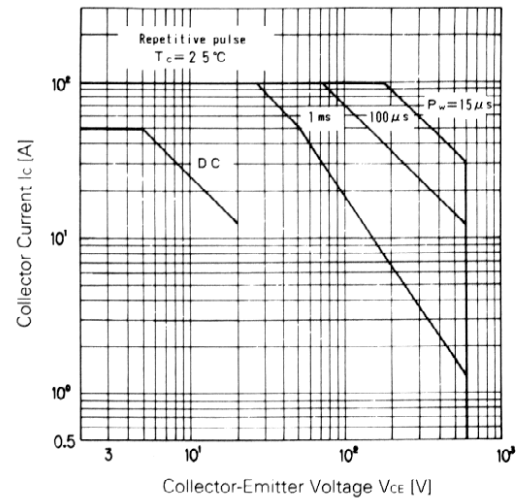

Safe Operating Area