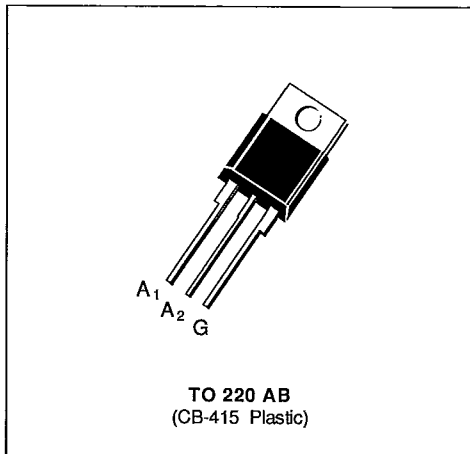

- $I_{RMS} = 12\text{ A}$ at $T_c = 85\text{ }^\circ\text{C}$.
- $V_{DRM} : 200\text{ V to }800\text{ V}$.
- $I_{GT} = 75\text{ mA}$ (QI-II-III).
- GLASS PASSIVATED CHIP.
- HIGH SURGE CURRENT : $I_{TSM} = 120\text{ A}$.
- HIGH COMMUTATION CAPABILITY :
(di/dt)_c > 16 A / ms without snubber.
- INSULATING VOLTAGE : 2500 V_{RMS} .
- UL RECOGNIZED (E81734).

**DESCRIPTION**

New range suited for applications such as phase control and static switching on inductive or resistive load.

ABSOLUTE RATINGS (limiting values)

Symbol	Parameter		Value	Unit
I_{RMS}	RMS on-state current (360 ° conduction angle)	$T_c = 85\text{ }^\circ\text{C}$	12	A
I_{TSM}	Non repetitive surge peak on-state current (T_j initial = 25 °C)	$t = 8.3\text{ ms}$	126	A
		$t = 10\text{ ms}$	120	
$I^2 t$	$I^2 t$ value	$t = 10\text{ ms}$	72	$A^2\text{ s}$
di/dt	Critical rate of rise of on-state current (1)	Repetitive $F = 50\text{ Hz}$	20	A / μs
		Non Repetitive	100	
T_{stg} T_j	Storage and operating junction temperature range		- 40, + 150 - 40, + 125	$^\circ\text{C}$ $^\circ\text{C}$

Symbol	Parameter	BTA 12-					Unit
		200 AW	400 AW	600 AW	700 AW	800 AW	
V_{DRM}	Repetitive peak off-state voltage (2)	± 200	± 400	± 600	± 700	± 800	V

(1) Gate supply : $I_G = 750\text{ mA} - di_G / dt = 1\text{ A} / \mu\text{s}$.

(2) $T_j = 125\text{ }^\circ\text{C}$.

THERMAL RESISTANCES

Symbol	Parameter	Value	Unit
$R_{th(j-a)}$	Junction to ambient	60	°C/W
$R_{th(j-c) DC}$	Junction to case for DC	3.3	°C/W
$R_{th(j-c) AC}$	Junction to case for 360 ° conduction angle (F = 50 Hz)	2.5	°C/W

GATE CHARACTERISTICS (maximum values)

$P_{GM} = 40 W$ (t = 10 μs) $P_{G(AV)} = 1 W$ $I_{GM} = 4 A$ (t = 10 μs) $V_{GM} = 16 V$ (t = 10 μs).

ELECTRICAL CHARACTERISTICS

Symbol	Test Conditions		Quadrants	Min.	Typ.	Max.	Unit
I_{GT}	$T_j = 25\text{ °C}$ Pulse duration > 20 μs	$V_D = 12 V$ $R_L = 33\ \Omega$	I-II-III	2		75	mA
V_{GT}	$T_j = 25\text{ °C}$ Pulse duration > 20 μs	$V_D = 12 V$ $R_L = 33\ \Omega$	I-II-III			1.5	V
V_{GD}	$T_j = 125\text{ °C}$ Pulse duration > 20 μs	$V_D = V_{DRM}$ $R_L = 3.3\ k\Omega$	I-II-III	0.2			V
I_H^*	$T_j = 25\text{ °C}$ Gate open	$I_T = 100\text{ mA}$ $R_L = 140\ \Omega$				75	mA
I_L	$T_j = 25\text{ °C}$ Pulse duration > 20 μs	$V_D = 12 V$ $I_G = 500\text{ mA}$	I-III		75		mA
			II		150		
V_{TM}^*	$T_j = 25\text{ °C}$	$I_{TM} = 17 A$				1.6	V
I_{DRM}^*	$T_j = 25\text{ °C}$	V_{DRM} rated Gate open				0.01	mA
	$T_j = 125\text{ °C}$					2	
dv/dt^*	$T_j = 125\text{ °C}$ Linear slope up to 0.67 V_{DRM}	Gate open V_{DRM}		750	1000		V/ μs
$(di/dt)_c^*$	$T_j = 125\text{ °C}$ Without snubber	V_{DRM} rated		16	32		A/ms
t_{gt}	$T_j = 25\text{ °C}$ $I_T = 17 A$	$di_G/dt = 3.5\text{ A}/\mu s$ $V_D = V_{DRM}$	$I_G = 500\text{ mA}$ I-II-III		2		μs

* For either polarity of electrode A₂ voltage with reference to electrode A₁.

SGS-THOMSON

T-25-15

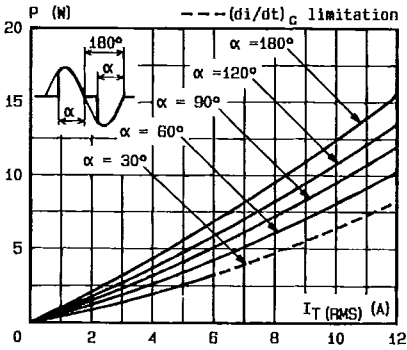

Fig.1 - Maximum mean power dissipation versus RMS on-state current ($F = 60$ Hz).

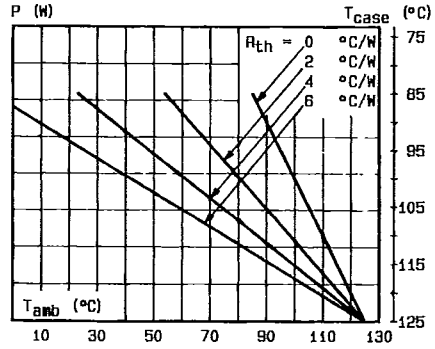

Fig.2 - Correlation between maximum mean power dissipation and maximum allowable temperatures (T_{amb} and T_{case}) for different thermal resistances heatsink + contact.

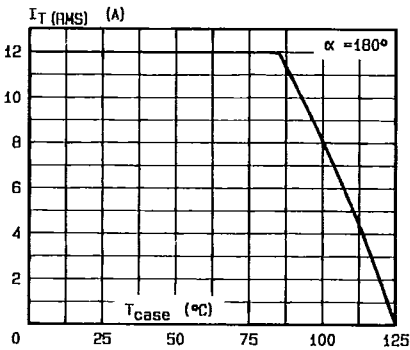

Fig.3 - RMS on-state current versus case temperature.

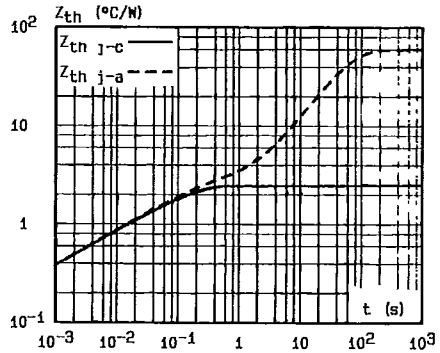

Fig.4 - Thermal transient impedance junction to case and junction to ambient versus pulse duration.

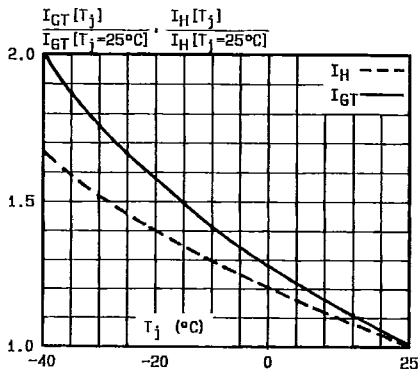

Fig.5 - Relative variation of gate trigger current and holding current versus junction temperature.

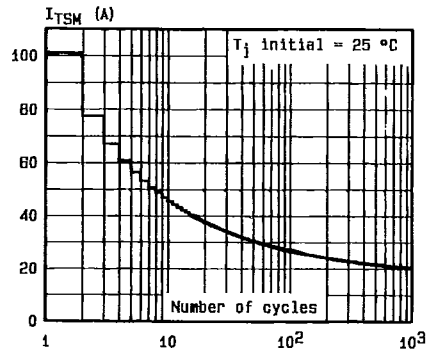

Fig.6 - Non repetitive surge peak on-state current versus number of cycles.

30E D ■ 7929237 0031527 4 ■

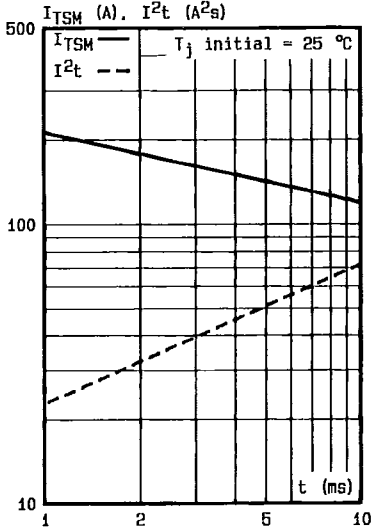

Fig.7 - Non repetitive surge peak on-state current for a sinusoidal pulse with width : $t \leq 10$ ms, and corresponding value of I^2t .

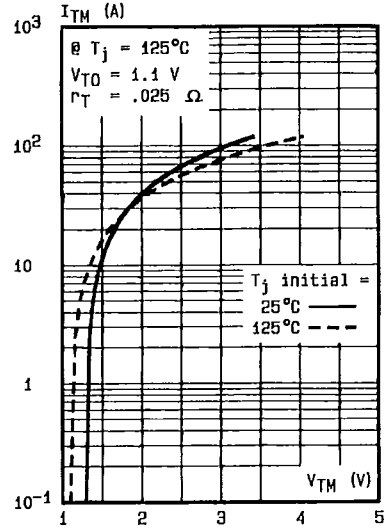
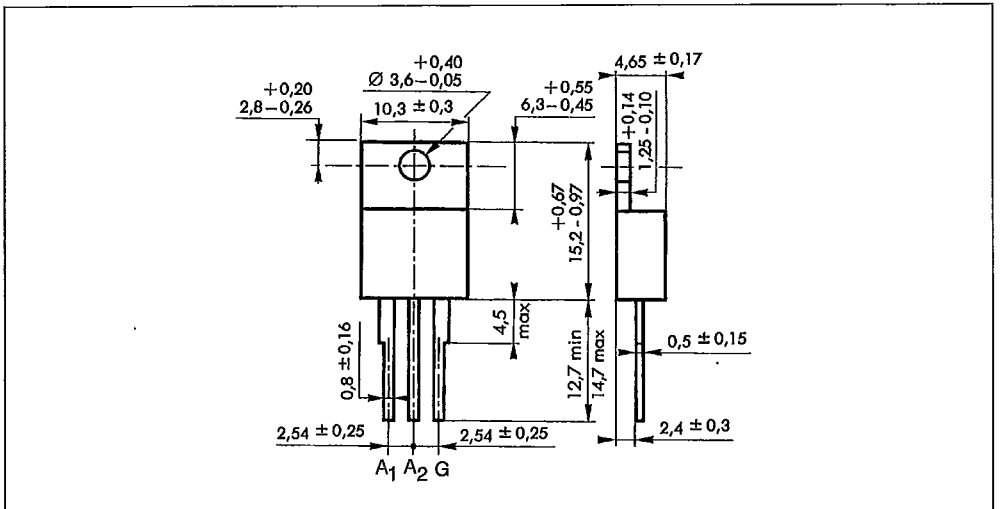

Fig.8 - On-state characteristics (maximum values).

PACKAGE MECHANICAL DATA

TO 220 AB (CB-415) Plastic



Cooling method : by conduction (method C)
 Marking : type number
 Weight : 2 g