

> **Features**

- High Speed Switching
- Low On-Resistance
- No Secondary Breakdown
- Low Driving Power
- High Voltage
- V_{GS} = ± 30V Guarantee
- Repetitive Avalanche Rated

> **Applications**

- Switching Regulators
- UPS
- DC-DC converters
- General Purpose Power Amplifier

> **Outline Drawing**

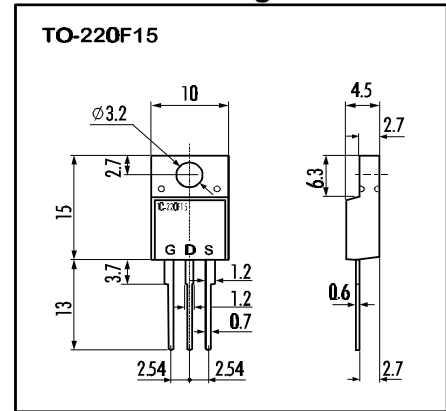

> **Maximum Ratings and Characteristics**

- Absolute Maximum Ratings (T_c=25°C), unless otherwise specified

Item	Symbol	Rating	Unit
Drain-Source-Voltage	V _{DS}	500	V
Continous Drain Current	I _D	10	A
Pulsed Drain Current	I _{D(puls)}	40	A
Gate-Source-Voltage	V _{GS}	±30	V
Repetitive or Non-Repetitive (T _{ch} ≤ 150°C)	I _{AR}	10	A
Avalanche Energy	E _{AS}	77,6	mJ
Max. Power Dissipation	P _D	50	W
Operating and Storage Temperature Range	T _{ch}	150	°C
	T _{stg}	-55 ~ +150	°C

> **Equivalent Circuit**

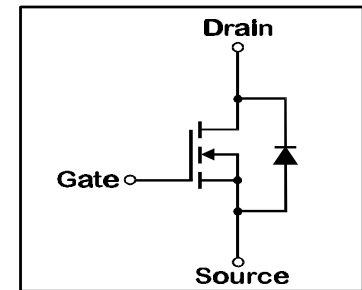

- Electrical Characteristics (T_C=25°C), unless otherwise specified

Item	Symbol	Test conditions	Min.	Typ.	Max.	Unit
Drain-Source Breakdown-Voltage	V _{(BR)DSS}	I _D =1mA V _{GS} =0V	500			V
Gate Threshold Voltage	V _{GS(th)}	I _D =1mA V _{DS} =V _{GS}	3,5	4,0	4,5	V
Zero Gate Voltage Drain Current	I _{DSS}	V _{DS} =500V T _{ch} =25°C		10	500	μA
		V _{GS} =0V T _{ch} =125°C		0,2	1,0	mA
Gate Source Leakage Current	I _{GSS}	V _{GS} =±30V V _{DS} =0V		10	100	nA
Drain Source On-State Resistance	R _{DS(on)}	I _D =5A V _{GS} =10V		0,73	0,90	Ω
Forward Transconductance	g _{fs}	I _D =5A V _{DS} =25V	2,5	5		S
Input Capacitance	C _{iss}	V _{DS} =25V		950	1450	pF
Output Capacitance	C _{oss}	V _{GS} =0V		180	270	pF
Reverse Transfer Capacitance	C _{rss}	f=1MHz		80	120	pF
Turn-On-Time t _{on} (t _{on} =t _{d(on)} +t _r)	t _{d(on)}	V _{CC} =300V		25	40	ns
	t _r	I _D =10A		70	110	ns
Turn-Off-Time t _{off} (t _{off} =t _{d(off)} +t _f)	t _{d(off)}	V _{GS} =10V		70	110	ns
	t _f	R _{GS} =10 Ω		45	70	ns
Avalanche Capability	I _{AV}	L = 100μH T _{ch} =25°C	10			A
Diode Forward On-Voltage	V _{SD}	I _F =2I _{DR} V _{GS} =0V T _{ch} =25°C		1,1	1,65	V
Reverse Recovery Time	t _{rr}	I _F =I _{DR} V _{GS} =0V		450		ns
Reverse Recovery Charge	Q _{rr}	-di _F /dt=100A/μs T _{ch} =25°C		5,5		μC

- Thermal Characteristics

Item	Symbol	Test conditions	Min.	Typ.	Max.	Unit
Thermal Resistance	R _{th(ch-a)}	channel to air			62,5	°C/W
	R _{th(ch-c)}	channel to case			2,5	°C/W

N-channel MOS-FET			
500V	0,9Ω	10A	50W

2SK2640-01MR

FAP-IIS Series



> Characteristics

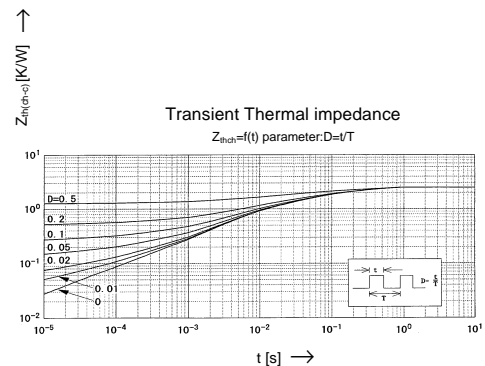
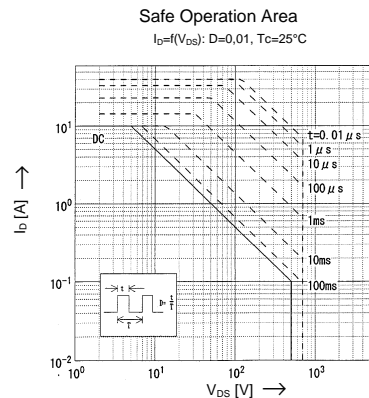
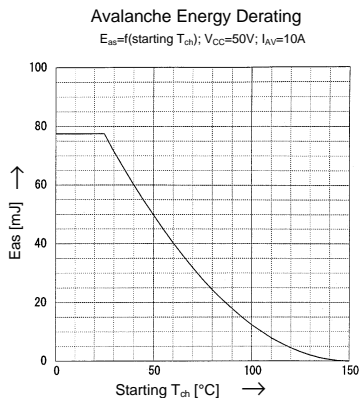
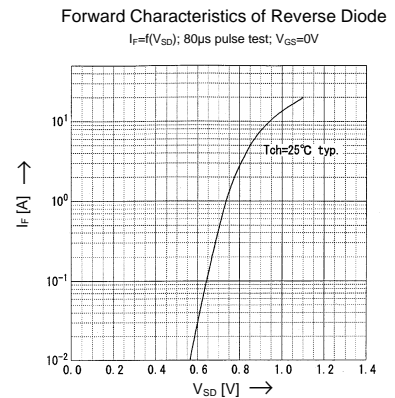
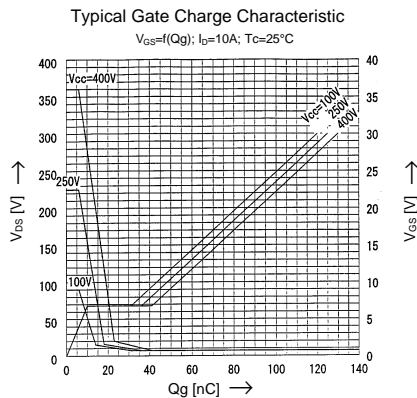
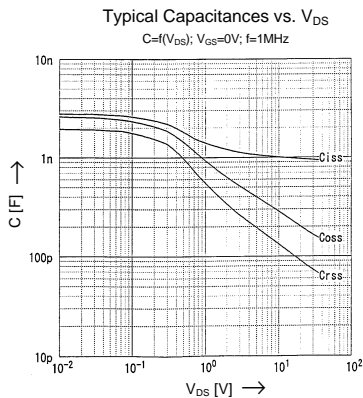
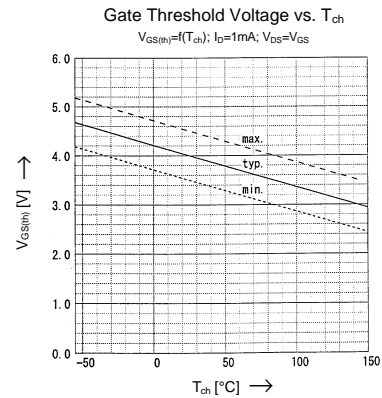
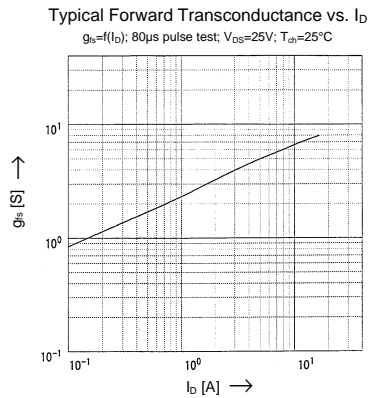
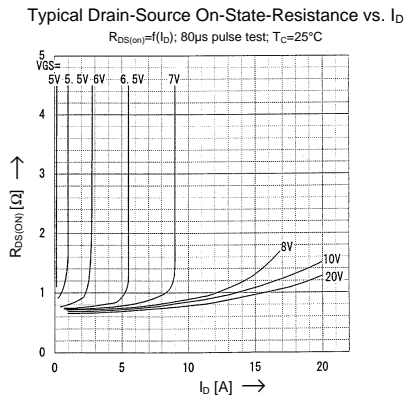
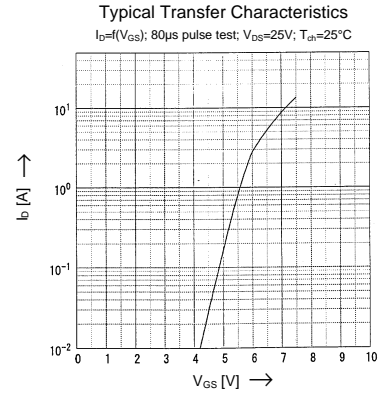
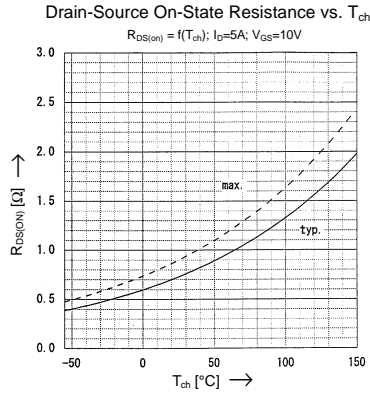
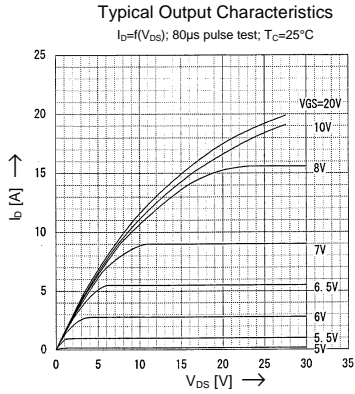

This specification is subject to change without notice!