

# 2SK2339

## Silicon N-Channel Power F-MOS

### ■ Features

- Avalanche energy capability guaranteed
- Low ON-resistance
- No secondary breakdown
- Low-voltage drive

### ■ Applications

- Non-contact relay
- Solenoid drive
- Motor drive
- Control equipment
- Switching mode regulator

### ■ Absolute Maximum Ratings (T<sub>c</sub> = 25°C)

Parameter	Symbol	Rating	Unit	
Drain-Source breakdown voltage	V <sub>DSS</sub>	80±10	V	
Gate-Source voltage	V <sub>GSS</sub>	±15	V	
Drain current	DC	I <sub>D</sub>	±10	A
	Pulse	I <sub>DP</sub>	±20	A
Avalanche energy capability	EAS *	62.5	mJ	
Allowable power dissipation	T <sub>c</sub> = 25°C	P <sub>D</sub>	30	W
	T <sub>a</sub> = 25°C		1.3	
Channel temperature	T <sub>ch</sub>	150	°C	
Storage temperature	T <sub>stg</sub>	-55 to +150	°C	

\* L= 5mH, I<sub>L</sub>= 5A, 1 pulse

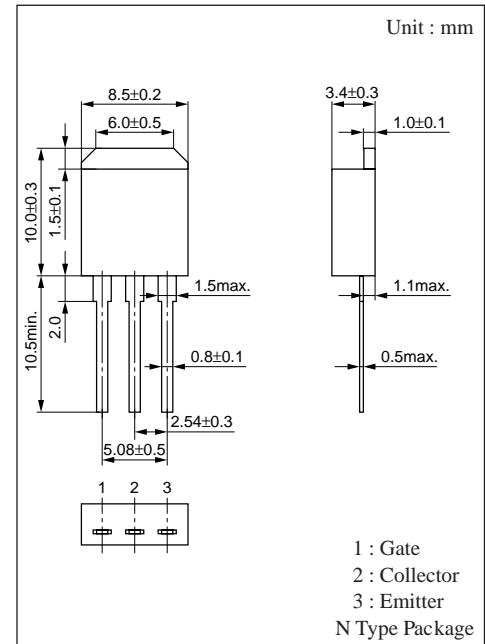

### ■ Equivalent Circuit

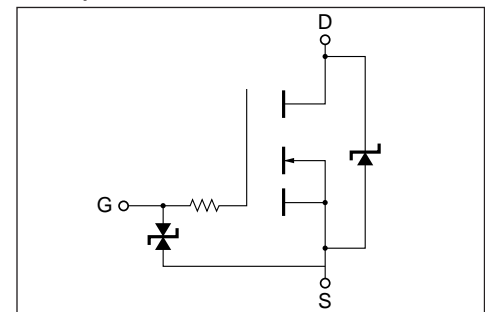

### ■ Electrical Characteristics (T<sub>c</sub> = 25°C)

Parameter	Symbol	Condition	Min	Typ	Max	Unit
Drain-Source cut-off current	I <sub>DSS</sub>	V <sub>DS</sub> = 70V, V <sub>GS</sub> = 0			10	μ A
Gate-Source leakage current	I <sub>GSS</sub>	V <sub>DS</sub> = 0, V <sub>GS</sub> =15V			±10	μ A
Drain-Source breakdown voltage	V <sub>DSS</sub>	I <sub>D</sub> =1mA, V <sub>GS</sub> = 0	70		90	V
Gate threshold voltage	V <sub>th</sub>	V <sub>DS</sub> =10V, I <sub>D</sub> =1mA	1		2.5	V
Drain-Source ON-resistance	R <sub>DS(on)1</sub>	V <sub>GS</sub> =10V, I <sub>D</sub> = 5A		150	230	mΩ
	R <sub>DS(on)2</sub>	V <sub>GS</sub> = 4V, I <sub>D</sub> = 5A		230	370	mΩ
Forward transadmittance	Y <sub>fs</sub>	V <sub>DS</sub> =10V, I <sub>D</sub> = 5A	3	5.5		S
Diode forward voltage	V <sub>DSF</sub>	I <sub>DR</sub> =10A, V <sub>GS</sub> = 0			-1.8	V
Reverse recovery time	t <sub>rr</sub>	L=230μ H, V <sub>DD</sub> = 30V, V <sub>GS</sub> = 0		0.55		μ s
Reverse recovery charge	Q <sub>rr</sub>	I <sub>DR</sub> =10A, di/dt= 80A/μ s		2.2		μ s
Input capacitance	C <sub>iss</sub>	V <sub>DS</sub> =10V, V <sub>GS</sub> = 0, f= 1MHz		85		pF
Output capacitance	C <sub>oss</sub>		250		pF	
Feedback capacitance	C <sub>rss</sub>		20		pF	
Turn-on time	t <sub>on</sub>			0.5		μ s
Fall time	t <sub>f</sub>	V <sub>DD</sub> = 30V, I <sub>D</sub> = 5A		0.9		μ s
Turn-off time (delay time)	t <sub>d(off)</sub>	V <sub>GS</sub> =10V, R <sub>L</sub> = 6Ω		1.9		μ s
Channel-Case heat resistance	R <sub>th(ch-c)</sub>				4.2	°C/W
Channel-Atmosphere heat resistance	R <sub>th(ch-a)</sub>				96	°C/W

Area of safe operation (ASO)

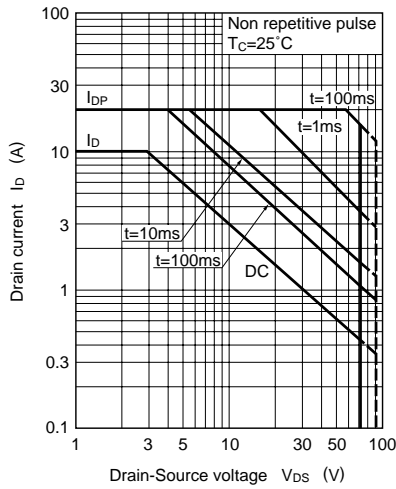

$P_D - T_a$

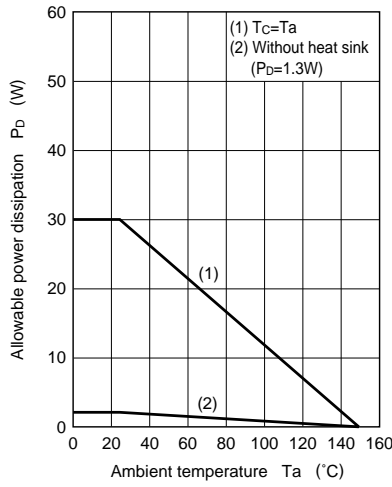

IAS - L-load

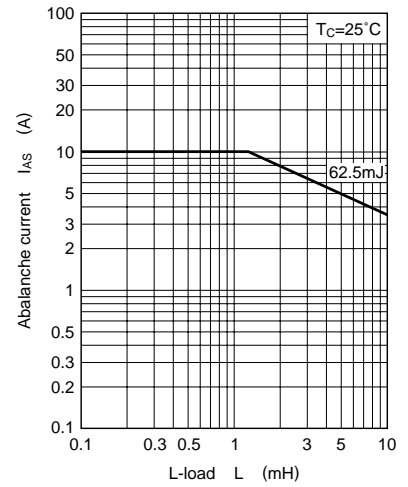

$I_D - V_{DS}$

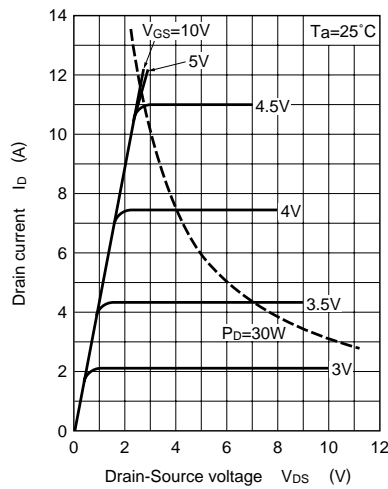

$I_D - V_{GS}$

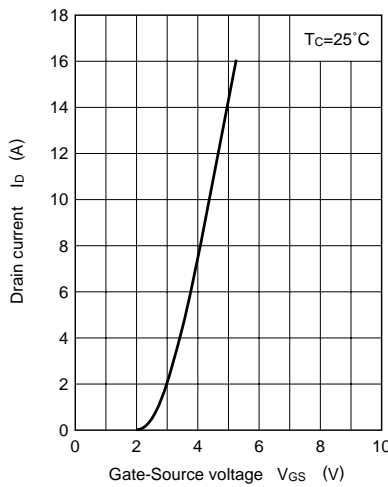

$V_{th} - T_C$

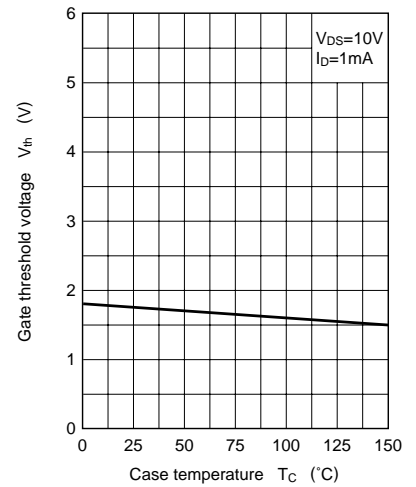

$R_{DS(on)} - I_D$

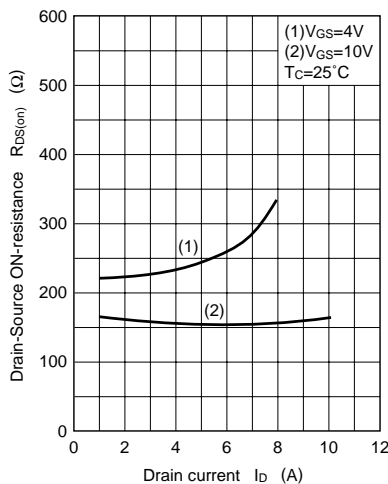

$R_{DS(on)} - V_{GS}$

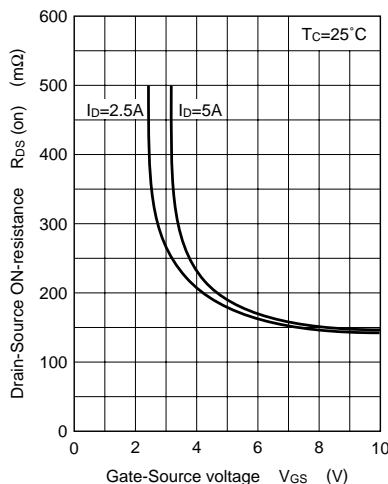

$|Y_{fs}| - I_D$

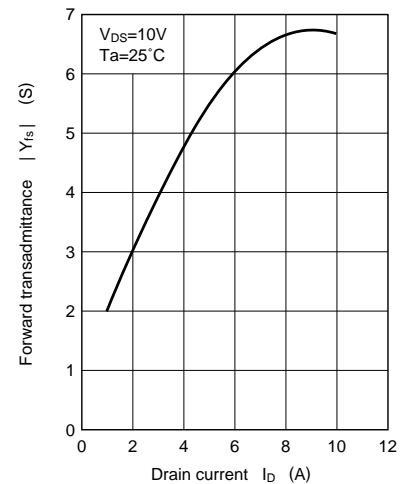

$C_{iss}, C_{oss}, C_{rss} - V_{DS}$

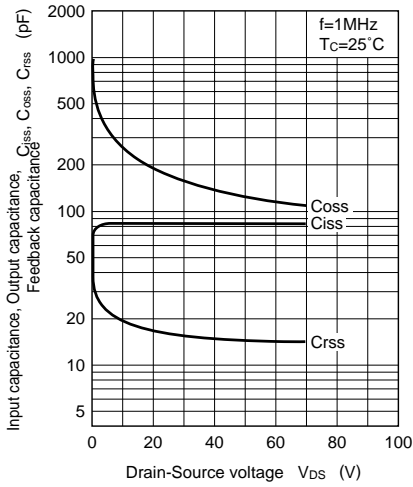

$t_{d(off)}, t_r, t_{on} - I_D$

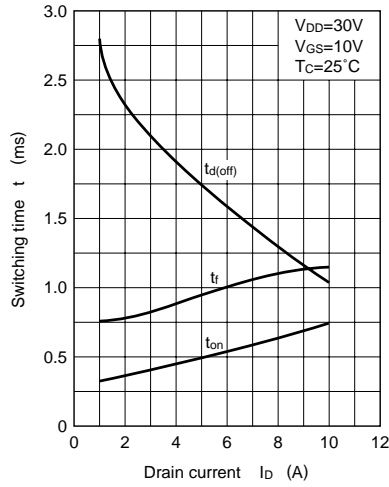

$V_{DS}, V_{GS} - Q_g$

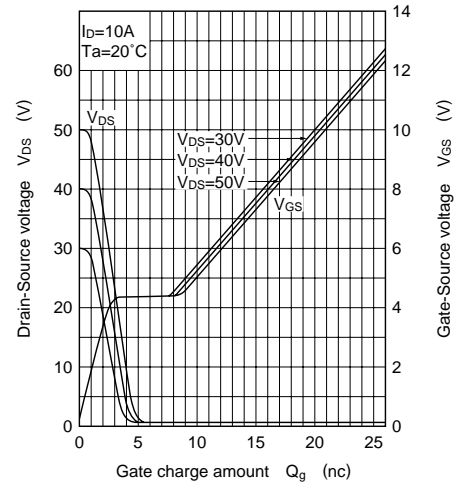

$I_{SD} - V_{SD}$

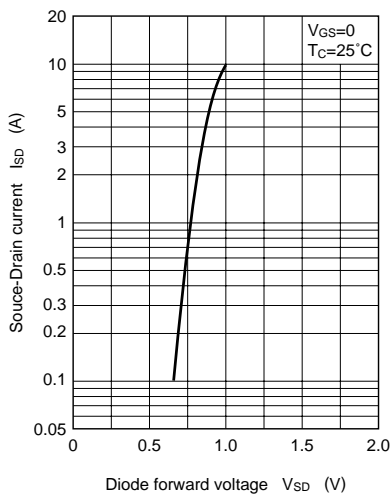

$R_{th} - t_p$

