

INTRODUCTION

The S1A0900X01 is a monolithic integrated circuit which consists of a 3V one-chip tuner and FM multiplex for AM/FM radios and head-phone radios.

FUNCTIONS

- FM Stage: RF/IF/AF amp, Quadrature Detector, MIX, OSC, Tuning Indicator.
- AM Stage: RF/IF/AF amp, Detector, MIX, OSC, AGC, Tuning Indicator.
- MPX Stage: PLL amp, Decoder, Flip Flop, VCO Stop, Phase Detector, Stereo Indicator.

FEATURES

- 3 V one-chip tuner with built-in FM Multiplex
- No AM detect coil, IF coupling capacitor, FM IF by-pass capacitor needed
- Built-in tuning indicator function
- Built-in AM/FM selection switch
- Minimum number of external parts required
- Wide operating voltage range: $V_{CC} = 1.8V - 7V$
- Low distortion (FM IF: 0.4%, AM IF: 1%, 0.2% (Typ))

OPDERING INFORMATION

Device	Package	Operature Temperature
S1A0900X01-A0B0	24-SDIP-300	- 20°C - +75°C
S1A0900X01-S0B0	24-SOP-375	

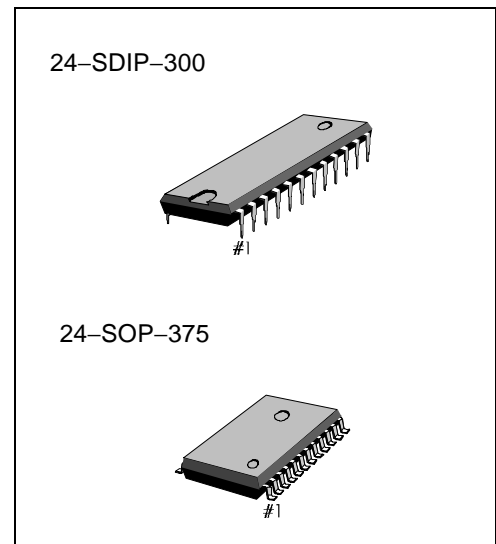

BLOCK DIAGRAM

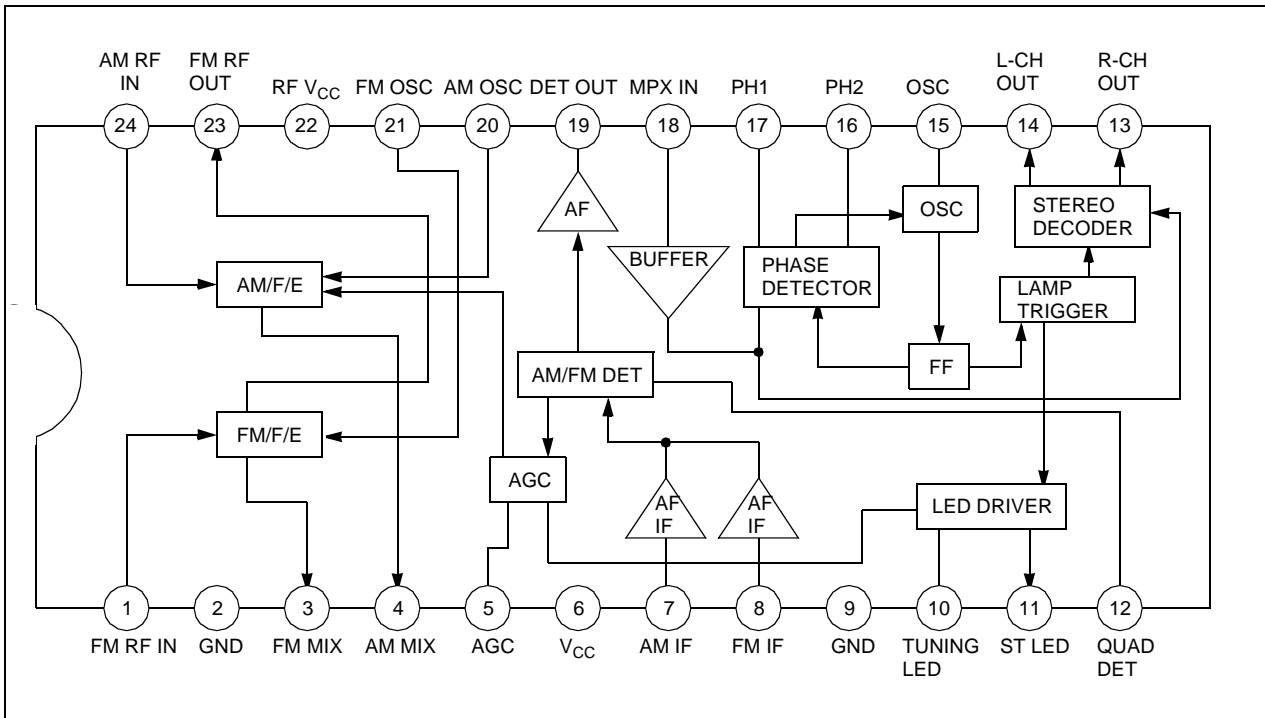

ABSOLUTE MAXIMUM RATINGS (Ta = 25°C)

Characteristic	Symbol	Value	Unit
Supply Voltage	V _{CC}	8	V
Power Dissipation	P _D	1200	mW
Operating Temperature	T _{OPR}	-20 – +75	°C
Storage Temperature	T _{STG}	-55 – +150	°C
LED Driver Voltage	V _{DR}	10	V
LED Driver Current	I _{DR}	10	mA

ELECTRICAL CHARACTERISTICS

(Ta = 25°C, V_{CC} = 3V, unless otherwise specified)

- FM F/E: f = 98MHz, fm = 1kHz, Δf = 22.5kHz, AM: f = 1kHz, 30 % Mod
- FM IF: f = 10.7MHz, fm = 1kHz, Δf = 22.5kHz, MPX: f = 1kHz, L + R = 90 %, P = 10%, V_I = 150mV

Characteristic		Symbol	Test Conditions	Min.	Typ.	Max.	Unit	Test Circuit
Quiescent Circuit Current		I _{CCQ1}	FM, V _I = 0	8.4	13.2	20.0	mA	1
		I _{CCQ2}	AM, V _I = 0	4.4	8.4	13.4	mA	1
F/E	-3 dB Limiting Sensitivity	V _{I(LIM)1}	V _O = -3dB	-	10	-	dBμ	1
	Oscillation Voltage	V _{OSC}	f _{OSC} = 98MHz	40	70	110	mV	2
FM IF	-3 dB Limiting Sensitivity	V _{I(LIM)2}	V _O = -3dB	40	46	53	dBμ	1
	Detector Output Voltage	V _{O(DET)1}	V _I = 80dBμ	55	80	110	mV	1
	Signal to Noise Ratio	S/N ₁	V _I = 80dBμ	60	70	-	dB	1
	Total Harmonic Distortion	THD ₁	V _I = 80dBμ	-	0.4	1	%	1
	AM Rejection Ratio	AMR	V _I = 80dBμ	22	32	-	dB	1
	Tuning Indication Voltage	V _{LI}	I _{LED} = 1mA	45	51	56	dBμ	1
AM IF	Voltage Gain	G _{V1}	V _I = 26dBμ	40	70	110	mV	1
	Detector Output Voltage	V _{O(DET)2}	V _I = 60dBμ	55	80	110	mV	1
	Signal to Noise Ratio	S/N ₂	V _I = 60dBμ	32	42	-	dB	1
	Total Harmonic Distortion	THD ₂	V _I = 60dBμ	-	1	2	%	1
	Tuning Indication Voltage	V _{LI2}	I _{LED} = 1mA	20	25	30	dBμ	1

Characteristic		Symbol	Test Conditions	Min.	Typ.	Max.	Unit	Test Circuit
MPX	Maximum Input Voltage	$V_{I(MAX)}$	Stereo, THD = 3%	250	350	–	mV	1
	Channel Separation	CS_1	Stereo, f = 100Hz	35	42	–	dB	1
		CS_2	Stereo, f = 1kHz	35	42	–	dB	1
		CS_3	Stereo, f = 10kHz	35	42	–	dB	1
	Total Harmonic Distortion	THD_3	Mono	–	0.2	1	%	1
		THD_4	Stereo	–	0.2	1	%	1
	Voltage Gain	G_{V2}	Mono	–5	–3	–1	dB	1
	Channel Balance	CB	Mono	–2	0	2	dB	1
	Lamp on Level	$V_{L(ON)}$	Pilot only	–	8	16	mV	1
		$V_{L(OFF)}$	Pilot only	2	6	–	mV	1
	Lamp Hysteresis	HY	–	–	2	–	mV	1
	Capture Range	CR	Pilot only	± 1	± 3	± 5	%	1
Signal to Noise Ratio	S/N ₃	Mono	60	70	–	dB	1	

TEST CIRCUIT 2

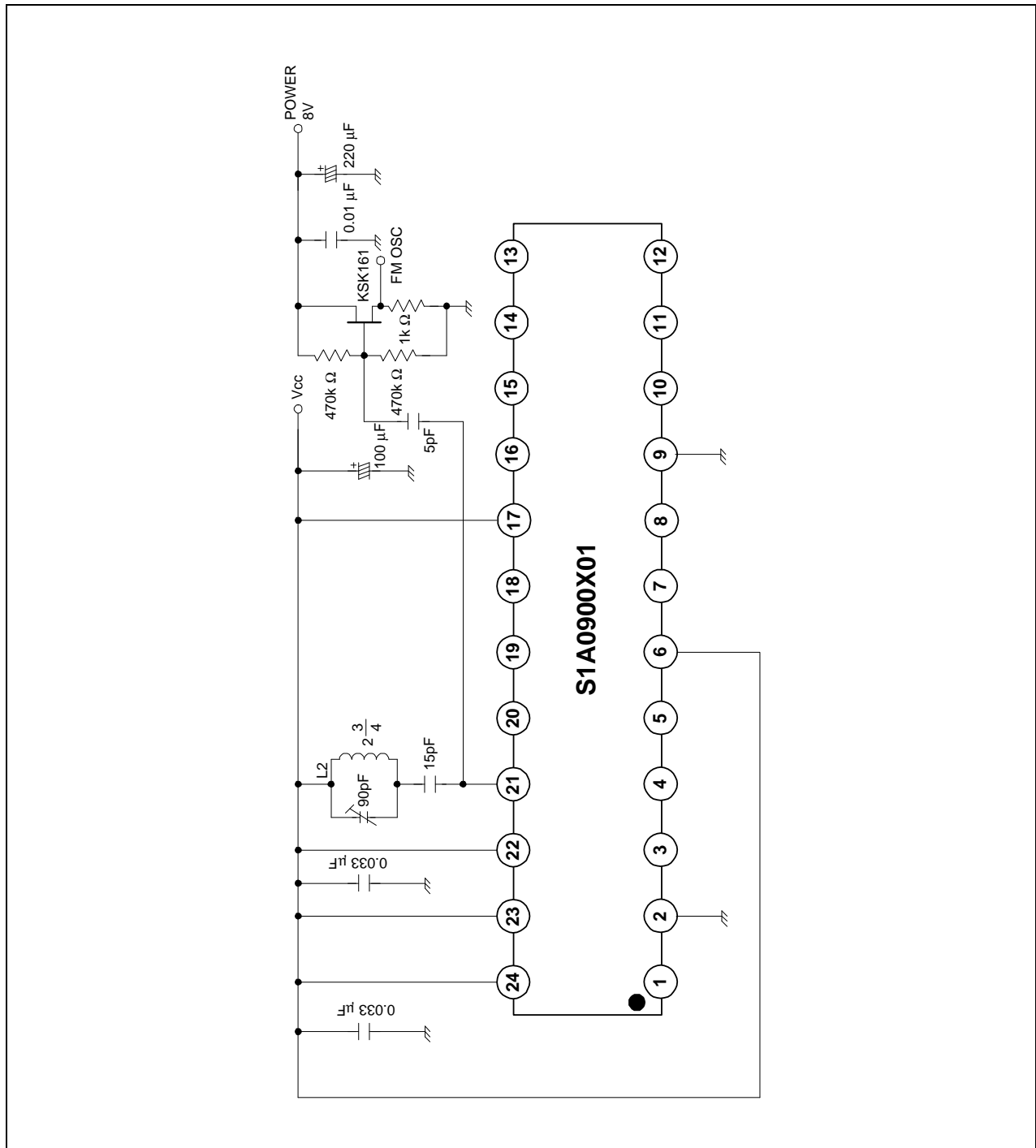

COIL SPECIFICATION

T1 FM IFT (MIX OUT)

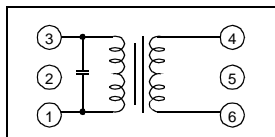

Co(pF)	f (MHz)	Qo	TURNS		
			1-3	4-6	
75	10.7	70(min)	11	2	

KOREA TOKO
0.1 mmφ

T2 AM IFT (MIX OUT)

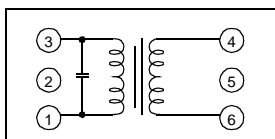

Co(pF)	f (MHz)	Qo	TURNS		
			1-3	4-6	
180	455	70(min)	180	15	

KOREA TOKO
0.08 mmφ

T3 FM IFT (DET)

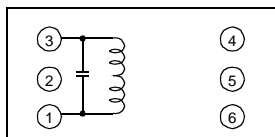

Co(pF)	f (MHz)	Qo	TURNS		
			1-3		
47	10.7	80(min)	14		

KOREA TOKO
0.1 mmφ

L1 FM RF

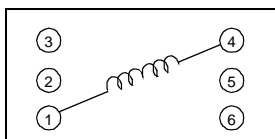

f (MHz)	Qo	TURNS		
		1-3		
100	100	2*(1/2)		

0.5 mmφ

L2 FM OSC

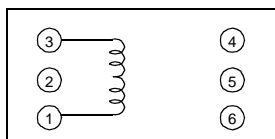

f (MHz)	Qo	TURNS		
		1-3		
100	100	2*(3/4)		

0.5 mmφ

L3 AM OSC

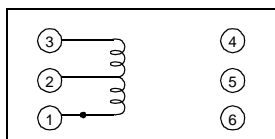

f (KHz)	Qo	TURNS		L (μH)
		1-2	2-3	
796	80(min)	13	15	288

KOREA TOKO
0.08 mmφ

T1 FM IFT (MIX OUT)

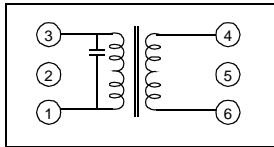

KSI-FA2

Co(pF)	F (MHz)	Qo	TURNS		KWANG SUNG PART NO
			1-3	4-6	
75	10.7	70(min)	11	2	KSI-FA2

T2 AM IFT (MIX OUT)

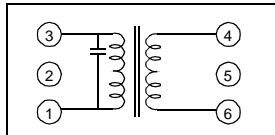

KSI-AA1

Co(pF)	F (MHz)	Qo	TURNS		KWANG SUNG PART NO
			1-3	4-6	
180	455	70(min)	146	14	KSI-AA1

T3 FM IFT (DET)

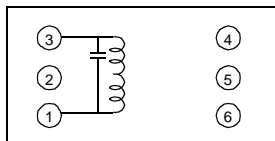

KSI-FD3

Co (pF)	F (MHz)	Qo	TURNS	KWANG SUNG PART NO
			1-3	
47	10.7	80(min)	14	KSI-FD3

L1 FM RF

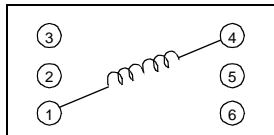

KST-FR1

F (MHz)	Qo	TURNS		KWANG SUNG PART NO
		1-3	WIRE	
100	100	2*(1/2)	0.5m/m	KST-FR1

L2 FM OSC

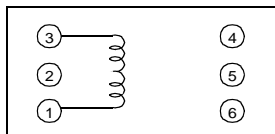

KST-FO1

F (MHz)	Qo	TURNS		KWANG SUNG PART NO
		1-3	WIRE	
100	100	2*(3/4)	0.5m/m	KST-AO1

L3 AM OSC

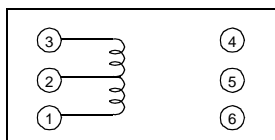

KSI-AO1

F (MHz)	Qo	TURNS		L (uH)	KWANG SUNG PART NO
		1-2	2-3		
796	80min	13	73	288	KSI-AO1

NOTES