

字高6~8mmH 3~4桁LED数字表示素子 6~8mmH 3~4Digits LED Numeric Displays

Ta=25℃

機種名 Type No.		外觀 結線圖 Drawing No.	色 Color		絶対最大定格 Absolute Maximum Ratings					推奨動作電流 IF/seg Recommend.	電氣的光学的特性 Optoelectric Characteristics					波長 Peak Wave Length
					IF/seg	IFP/seg	VR/seg	P _D	T _{opr}		V _f Typ.	IF	Luminous Typ.	Intensity IF	I _r Max (VR=3V) μA	
Com.-Anode	Com.-Cathode		Red	Green	mA	mA	V	W	℃	mA	V	mA	μcd	mA	(VR=3V) μA	nm
SL-1405		L-18	○		15	60	3	0.9	-25~65	5~10	1.9	5	150	5	10	700
SL-2405		L-18		○	20	80	3	1.3	-25~65	10~15	2.05	15	200	15	10	565
SL-1405-20	SL-1406-20	L-19	○		15	60	3	1.0	-25~65	5~10	1.9	5	150	5	10	700
SL-2405-20	SL-2406-20	L-19		○	20	80	3	1.4	-25~65	10~15	2.05	15	200	15	10	565
SL-1495	SL-1496	L-20	○		15	60	3	0.9	-25~65	5~10	1.9	5	150	5	10	700
SL-2495	SL-2496	L-20		○	20	80	3	1.2	-25~65	10~15	2.05	15	200	15	10	565
	SL-1032	L-21	○		15	60	3	1.0	-25~65	5~10	1.9	5	150	5	10	700
	SL-2032	L-21		○	20	80	3	1.4	-25~65	10~15	2.05	15	200	15	10	565
	SL-1064-20	L-22	○		15	70	3	1.2	-25~75	3~10	1.9	5	180	5	10	700
	SL-2064-20K	L-22		○	20	90	3	1.7	-25~75	8~12	2.05	15	240	15	10	565
SL-1321-01		L-23	○		15	60	3	0.7	-25~65	5~10	1.9	5	150	5	10	700
SL-2321-01		L-23		○	20	80	3	1.0	-25~65	10~15	2.05	15	200	15	10	565

※ Pulse width = 1ms. Duty Ratio 1/4 I_{FP}:I_F Pulse = Pulsed Forward Current

用途

周波数クロック表示 (カーステレオ等)
カウンター表示 (回転計等)

APPLICATIONS

Clock Frequency indication (Car stereo, etc.)
Counter indication (Tachometer, etc.)

L-18 SL-1405 SL-2405

Tolerance : ±0.25
Unit : mm

PIN NO.	ADDRESS	PIN NO.	ADDRESS
1	dp3 Cathode	12	D4 Common Anode
2	D1 Common Anode	13	a Cathode
3	c Cathode	14	g "
4	e "	15	N.C (NO PIN)
5	C2 "	16	N.C (")
6	D3 Common Anode	17	C1 Cathode
7	N.C (NO PIN)	18	D2 Common Anode
8	d Cathode	19	f Cathode
9	dp1 "	20	b "
10	N.C (NO PIN)	21	dp2 "
11	N.C (")	22	dp2 dp3 Common Anode

Com. Anode SL-1405, 2405

L-19 SL-1405-20 SL-1406-20 SL-2405-20 SL-2406-20

Tolerance : ±0.25
Unit : mm

PIN NO.	ADDRESS	PIN NO.	ADDRESS
1	N.C	12	D-4 Common Anode
2	N.C (NO PIN)	13	a Cathode
3	c Cathode	14	g "
4	e "	15	N.C (NO PIN)
5	C2 "	16	N.C (NO PIN)
6	D-3 Common Anode	17	C1 Cathode
7	N.C (NO PIN)	18	D-2 Common Anode
8	d Cathode	19	N.C (NO PIN)
9	d-p "	20	b Cathode
10	N.C (NO PIN)	21	f "
11	N.C (NO PIN)	22	D-1 Common

Com Anode SL-1405-20, 2405-20

LSI 1406-20, 2406-20 : LC-7961* (東三)

L-20

SL-1495, 1496
SL-2495, 2496

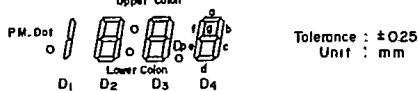
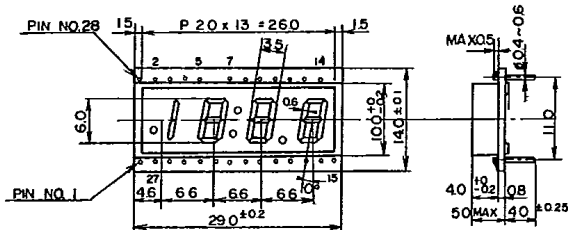

Tolerance : ±0.25
Unit : mm

PIN NO.	ADDRESS	PIN NO.	ADDRESS
1	Common Anode	15	D4 b Cathode
2	PM Dot Cathode	16	" d "
3	Dz e "	17	" f "
4	" d "	18	Ds g "
5	" c "	19	" b "
6	Lower Colon "	20	" a "
7	Ds e "	21	" f "
8	" d "	22	Upper Colon "
9	" c "	23	N. C
10	Dp "	24	Dz b "
11	" e "	25	" a "
12	" d "	26	" f "
13	" c "	27	" g "
14	" g "	28	D1 bc "

Com. Anode SL-1495, 2495



LSI 1495, 2495 : LC-7250* (東三)

L-21

SL-1032
SL-2032

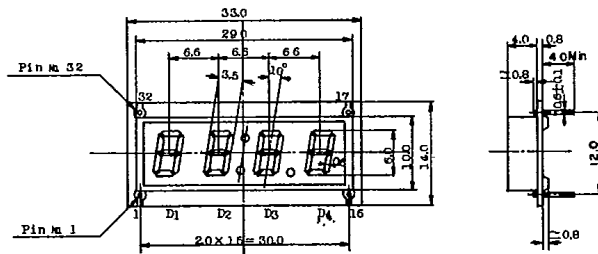

Tolerance : ±0.25
Unit : mm

Pin Connection

Pin No.	Address	Pin No.	Address
1	Common per All	17	D4 b
2	D1 e	18	" a
3	" d	19	" f
4	" c	20	D3 g
5	D2 e	21	" b
6	" d	22	" a
7	" c	23	" f
8	Lower Colon	24	Upper Colon
9	D3 e	25	D2 g
10	" d	26	" b
11	" c	27	" a
12	dp	28	" f
13	D4 e	29	D1 g
14	" d	30	" b
15	" c	31	" a
16	" g	32	" f

Common Cathode SL-1032, 2032

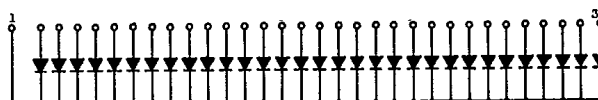

LSI 1032 : LC7257, LM8523, 8361, 8363, 8364* (東三)

L-22

SL-1064-20
SL-2064-20K

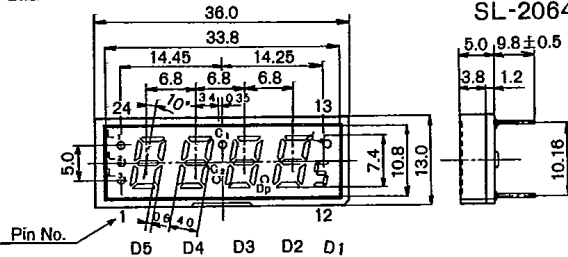

Tolerance : ±0.25
Unit : mm

PIN NO.	ADDRESS	PIN NO.	ADDRESS
1	L ₂ Cathode	13	L ₄ Anode
2	L ₃ //	14	D1(5) Cathode
3	L ₁ //	15	Dp //
4	D5 Common Cathode	16	C ₁ , C ₂ //
5	D4 //	17	D2 Common Cathode
6	C Anode	18	D3 //
7	C ₁ , C ₂ //	19	f Anode
8	d //	20	b //
9	e //	21	a //
10	Dp //	22	L ₁ //
11	g&D1(5) //	23	L ₃ //
12	L ₄ Cathode	24	L ₂ //

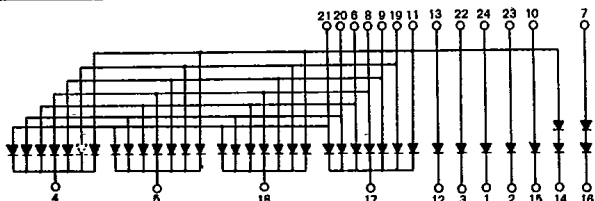

LSI 1064-20, 2064-20 : LC7961* (東三)

* TOKYO SANYO ELECTRIC CO., LTD.

L-23

SL-1321-01
SL-2321-01

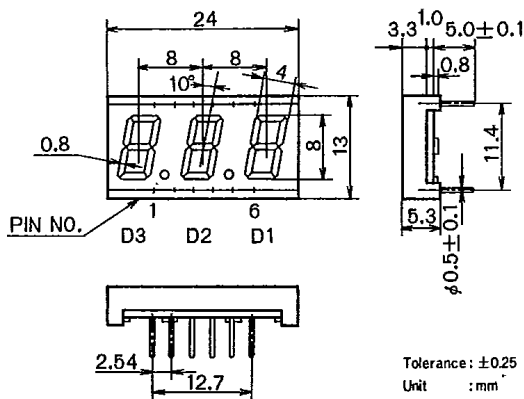

Tolerance : ±0.25
Unit : mm

PIN No.	ADDRESS	PIN No.	ADDRESS
1	D-3 COMMON ANODE	7	SEGMENT B CATHODE
2	D-2 "	8	" A "
3	D-1 "	9	d.p. CATHODE
4	SEGMENT E CATHODE	10	N.C.
5	" D "	11	SEGMENT F CATHODE
6	" C "	12	" G "

