

2SK133, 2SK134, 2SK135

SILICON N-CHANNEL MOS FET

HITACHI/(OPTOELECTRONICS)

LOW FREQUENCY POWER AMPLIFIER

Complementary pair with 2SJ48, 2SJ49, 2SJ50

FEATURES

- High Power Gain.
- Excellent Frequency Response.
- High Speed Switching.
- Wide Area of Safe Operation.
- Enhancement-Mode.
- Good Complementary Characteristics.
- Equipped with Gate Protection Diodes.

ABSOLUTE MAXIMUM RATINGS ($T_a=25^\circ\text{C}$)

Item	Symbol	Rating			Unit
		2SK133	2SK134	2SK135	
Drain-Source Voltage	V_{DS}	120	140	160	V
Gate-Source Voltage	V_{GS}	±14			V
Drain Current	I_D	7			A
Body-Drain Diode Reverse Drain Current	I_{DR}	7			A
Channel Dissipation	P_{ch} *	100			W
Channel Temperature	T_{ch}	150			°C
Storage Temperature	T_{stg}	-55 ~ +150			°C

*Value at $T_c=25^\circ\text{C}$

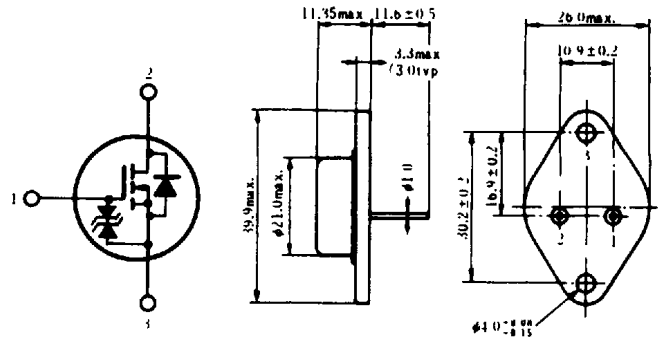

1. Gate
2. Drain
3. Source (Case)
(Dimensions in mm)

(JEDEC TO-3)

POWER VS. TEMPERATURE DERATING

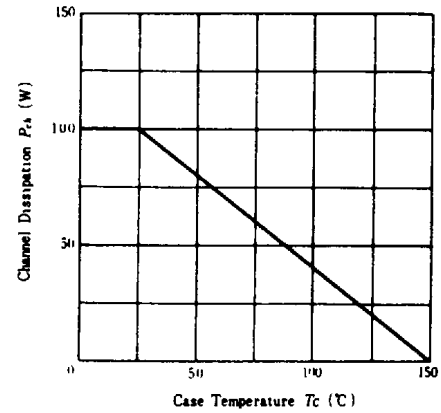

ELECTRICAL CHARACTERISTICS ($T_a=25^\circ\text{C}$)

Item	Symbol	Test Condition	min.	typ.	max.	Unit
Drain-Source Breakdown Voltage	$V_{(BR)DS}$	$I_D=10\text{mA}, V_{GS}=-10\text{V}$	120	—	—	V
			140	—	—	V
			160	—	—	V
Gate-Source Breakdown Voltage	$V_{(BR)GS}$	$I_G=\pm 100\mu\text{A}, V_{DS}=0$	±14	—	—	V
Gate-Source Cutoff Voltage	$V_{GS(off)}$	$I_D=100\text{mA}, V_{DS}=10\text{V}$	0.15	—	1.45	V
Drain-Source Saturation Voltage	$V_{DS(sat)}$	$I_D=7\text{A}, V_{GS}=0^*$	—	—	12	V
Forward Transfer Admittance	$ y_f $	$I_D=3\text{A}, V_{DS}=10\text{V}^*$	0.7	1.0	1.4	S
Input Capacitance	C_{iss}	$V_{GS}=-5\text{V}, V_{DS}=10\text{V}, f=1\text{MHz}$	—	600	—	pF
Output Capacitance	C_{oss}		—	350	—	pF
Reverse Transfer Capacitance	C_{rss}		—	10	—	pF
Turn-on Time	t_{on}	$V_{DD}=20\text{V}, I_D=4\text{A}$	—	180	—	ns
Turn-off Time	t_{off}		—	60	—	ns

*Pulse Test

HITACHI/(OPTOELECTRONICS)

MAXIMUM SAFE OPERATION AREA

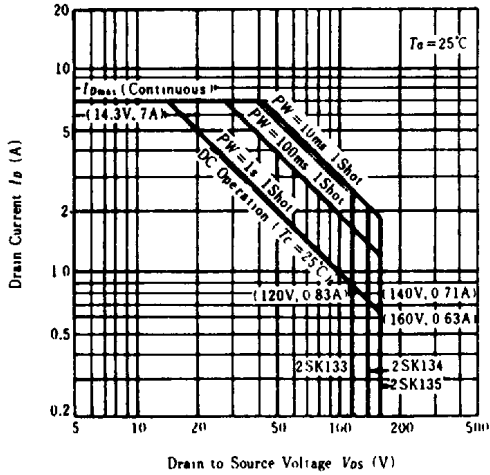

TYPICAL OUTPUT CHARACTERISTICS

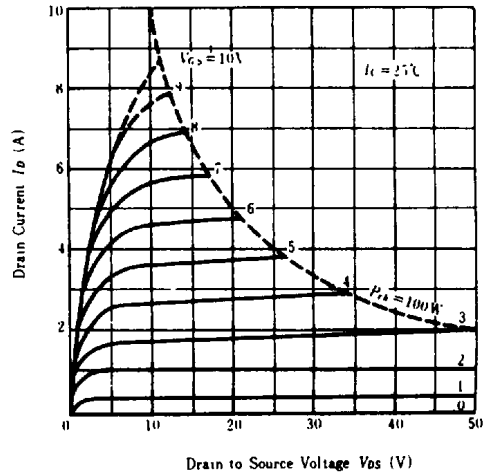

TYPICAL TRANSFER CHARACTERISTICS

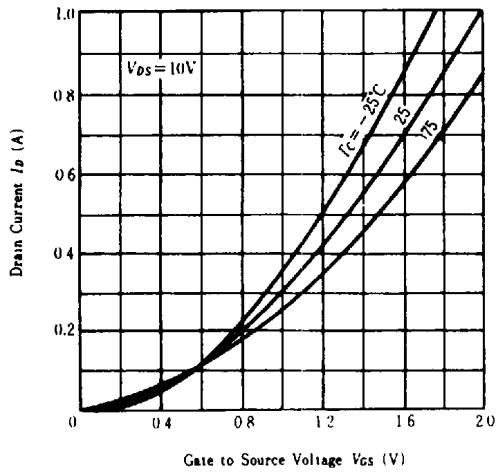

DRAIN - SOURCE SATURATION VOLTAGE VS. DRAIN CURRENT

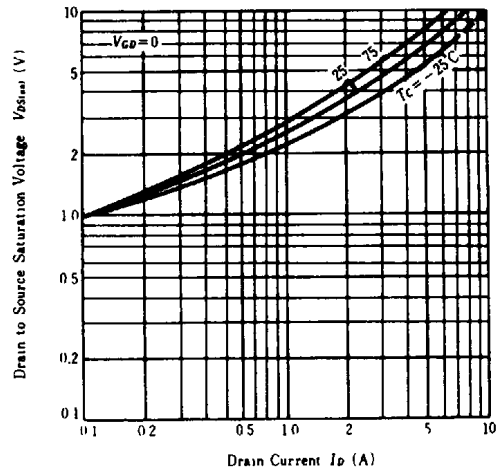

DRAIN - SOURCE VOLTAGE VS. GATE - SOURCE VOLTAGE

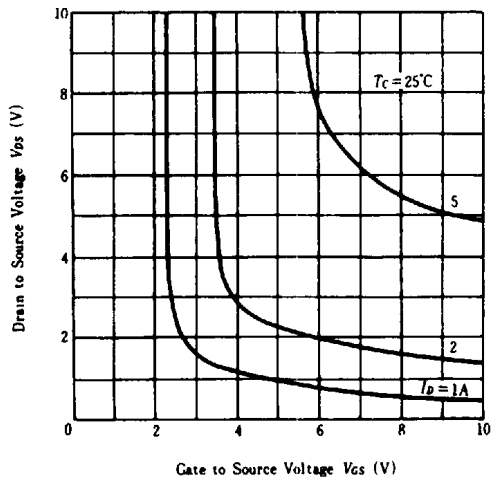

INPUT CAPACITANCE VS. GATE SOURCE VOLTAGE

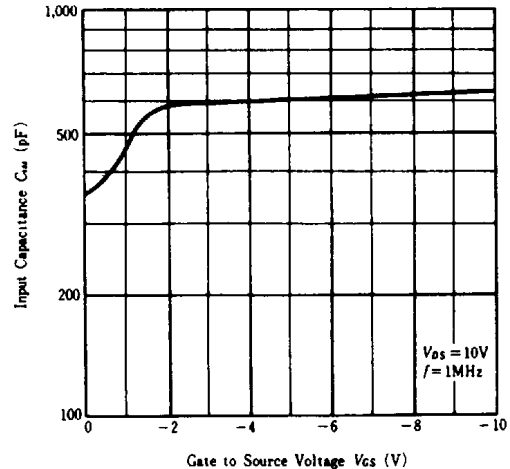

**FORWARD TRANSFER ADMITTANCE
VS. FREQUENCY**

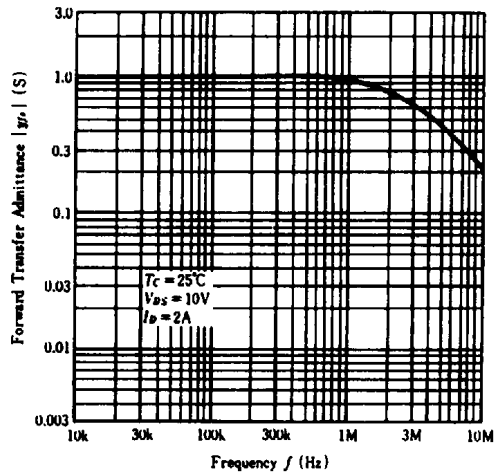

**SWITCHING TIME
VS. DRAIN CURRENT**

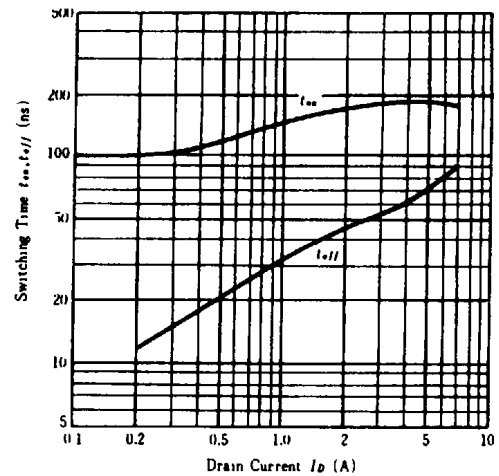

SWITCHING TIME TEST CIRCUIT

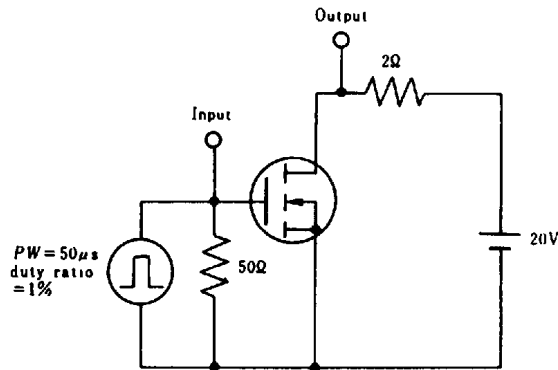

WAVEFORMS

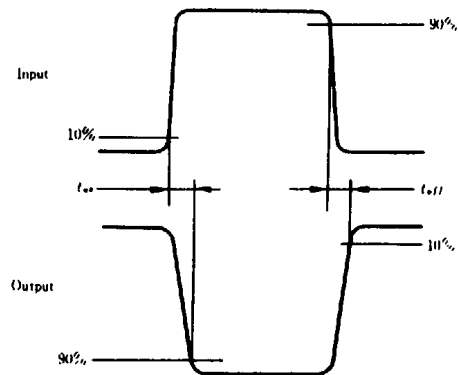

HITACHI/(OPTOELECTRONICS) 61E D