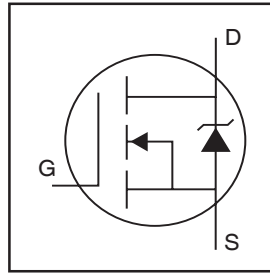


- Advanced Process Technology
- Surface Mount (IRFZ46NS)
- Low-profile through-hole (IRFZ46NL)
- 175°C Operating Temperature
- Fast Switching
- Fully Avalanche Rated
- Lead-Free

HEXFET® Power MOSFET



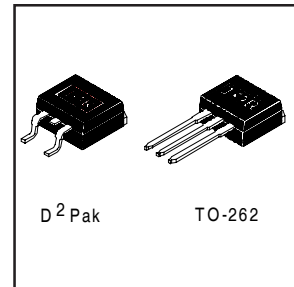
|                             |
|-----------------------------|
| $V_{DSS} = 55V$             |
| $R_{DS(on)} = 0.0165\Omega$ |
| $I_D = 53A^{\circ}$         |

### Description

Advanced HEXFET® Power MOSFETs from International Rectifier utilize advanced processing techniques to achieve extremely low on-resistance per silicon area. This benefit, combined with the fast switching speed and ruggedized device design that HEXFET power MOSFETs are well known for, provides the designer with an extremely efficient and reliable device for use in a wide variety of applications.

The D<sup>2</sup>Pak is a surface mount power package capable of accommodating die sizes up to HEX-4. It provides the highest power capability and the lowest possible on-resistance in any existing surface mount package. The D<sup>2</sup>Pak is suitable for high current applications because of its low internal connection resistance and can dissipate up to 2.0W in a typical surface mount application.

The through-hole version (IRFZ46NL) is available for low-profile applications.



D<sup>2</sup>Pak

TO-262

### Absolute Maximum Ratings

|                           | Parameter  | Max.                   | Units         |
|---------------------------|--|------------------------|---------------|
| $I_D @ T_C = 25^\circ C$  | Continuous Drain Current, $V_{GS} @ 10V^{\circ}$ | 53 $^{\circ}$          | A             |
| $I_D @ T_C = 100^\circ C$ | Continuous Drain Current, $V_{GS} @ 10V^{\circ}$ | 37                     |               |
| $I_{DM}$                  | Pulsed Drain Current $^{\circ}$ $^{\circ}$       | 180                    |               |
| $P_D @ T_A = 25^\circ C$  | Power Dissipation                                | 3.8                    | W             |
| $P_D @ T_C = 25^\circ C$  | Power Dissipation                                | 107                    | W             |
|                           | Linear Derating Factor                           | 0.71                   | W/ $^\circ C$ |
| $V_{GS}$                  | Gate-to-Source Voltage                           | $\pm 20$               | V             |
| $I_{AR}$                  | Avalanche Current $^{\circ}$                     | 28                     | A             |
| $E_{AR}$                  | Repetitive Avalanche Energy $^{\circ}$           | 11                     | mJ            |
| dv/dt                     | Peak Diode Recovery dv/dt $^{\circ}$ $^{\circ}$  | 5.0                    | V/ns          |
| $T_J$                     | Operating Junction and                           | -55 to + 175           | $^\circ C$    |
| $T_{STG}$                 | Storage Temperature Range                        |                        |               |
|                           | Soldering Temperature, for 10 seconds            | 300 (1.6mm from case ) |               |

### Thermal Resistance

|                 | Parameter  | Typ. | Max. | Units        |
|-----------------|--|------|------|--------------|
| $R_{\theta JC}$ | Junction-to-Case                                   | —    | 1.4  | $^\circ C/W$ |
| $R_{\theta JA}$ | Junction-to-Ambient ( PCB Mounted, steady-state)** | —    | 40   |              |

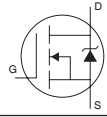
# IRFZ46NS/LPbF

International  
IR Rectifier

## Electrical Characteristics @ T<sub>J</sub> = 25°C (unless otherwise specified)

|  | Parameter                                  | Min. | Typ.             | Max.             | Units | Conditions  |
|--|--|------|------------------|------------------|-------|---|
| V <sub>(BR)DSS</sub>                   | Drain-to-Source Breakdown Voltage          | 55   | —                | —                | V     | V <sub>GS</sub> = 0V, I <sub>D</sub> = 250μA                        |
| ΔV <sub>(BR)DSS</sub> /ΔT <sub>J</sub> | Breakdown Voltage Temp. Coefficient        | —    | 0.057            | —                | V/°C  | Reference to 25°C, I <sub>D</sub> = 1mA <sup>⑤</sup>                |
| R <sub>DS(on)</sub>                    | Static Drain-to-Source On-Resistance       | —    | —                | .0165            | Ω     | V <sub>GS</sub> = 10V, I <sub>D</sub> = 28A <sup>④</sup>            |
| V <sub>GS(th)</sub>                    | Gate Threshold Voltage                     | 2.0  | —                | 4.0              | V     | V <sub>DS</sub> = V <sub>GS</sub> , I <sub>D</sub> = 250μA          |
| g <sub>fs</sub>                        | Forward Transconductance                   | 19   | —                | —                | S     | V <sub>DS</sub> = 25V, I <sub>D</sub> = 28A <sup>④⑤</sup>           |
| I <sub>DSS</sub>                       | Drain-to-Source Leakage Current            | —    | —                | 25               | μA    | V <sub>DS</sub> = 55V, V <sub>GS</sub> = 0V                         |
|  |  | —    | —                | 250              |       | V <sub>DS</sub> = 44V, V <sub>GS</sub> = 0V, T <sub>J</sub> = 150°C |
| I <sub>GSS</sub>                       | Gate-to-Source Forward Leakage             | —    | —                | 100              | nA    | V <sub>GS</sub> = 20V   |
|  | Gate-to-Source Reverse Leakage             | —    | —                | -100             |       | V <sub>GS</sub> = -20V  |
| Q <sub>g</sub>                         | Total Gate Charge                          | —    | —                | 72               | nC    | I <sub>D</sub> = 28A  |
| Q <sub>gs</sub>                        | Gate-to-Source Charge                      | —    | —                | 11               |       | V <sub>DS</sub> = 44V   |
| Q <sub>gd</sub>                        | Gate-to-Drain ("Miller") Charge            | —    | —                | 26               |       | V <sub>GS</sub> = 10V, See Fig. 6 and 13 <sup>④⑤</sup>              |
| t <sub>d(on)</sub>                     | Turn-On Delay Time                         | —    | 14               | —                | ns    | V <sub>DD</sub> = 28V   |
| t <sub>r</sub>                         | Rise Time                                  | —    | 76               | —                |       | I <sub>D</sub> = 28A  |
| t <sub>d(off)</sub>                    | Turn-Off Delay Time                        | —    | 52               | —                |       | R <sub>G</sub> = 12Ω  |
| t <sub>f</sub>                         | Fall Time                                  | —    | 57               | —                |       | R <sub>D</sub> = 0.98Ω, See Fig. 10 <sup>④⑤</sup>                   |
| L <sub>S</sub>                         | Internal Source Inductance                 | —    | 7.5              | —                | nH    | Between lead, and center of die contact                             |
| C <sub>iss</sub>                       | Input Capacitance                          | —    | 1696             | —                | pF    | V <sub>GS</sub> = 0V  |
| C <sub>oss</sub>                       | Output Capacitance                         | —    | 407              | —                |       | V <sub>DS</sub> = 25V   |
| C <sub>rss</sub>                       | Reverse Transfer Capacitance               | —    | 110              | —                |       | f = 1.0MHz, See Fig. 5 <sup>⑤</sup>                                 |
| E <sub>AS</sub>                        | Single Pulse Avalanche Energy <sup>②</sup> | —    | 583 <sup>⑥</sup> | 152 <sup>⑦</sup> |       | I <sub>AS</sub> = 28A, L = 389mH                                    |

## Source-Drain Ratings and Characteristics

|                 | Parameter                                       | Min.   | Typ. | Max. | Units | Conditions   |
|-----------------|---|--|------|------|-------|--|
| I <sub>S</sub>  | Continuous Source Current (Body Diode)          | —  | —    | 53   | A     | MOSFET symbol showing the integral reverse p-n junction diode.  |
| I <sub>SM</sub> | Pulsed Source Current (Body Diode) <sup>①</sup> | —  | —    | 180  |       |  |
| V <sub>SD</sub> | Diode Forward Voltage                           | —  | —    | 1.3  | V     | T <sub>J</sub> = 25°C, I <sub>S</sub> = 28A, V <sub>GS</sub> = 0V <sup>④</sup>   |
| t <sub>rr</sub> | Reverse Recovery Time                           | —  | 67   | 101  | ns    | T <sub>J</sub> = 25°C, I <sub>F</sub> = 28A  |
| Q <sub>rr</sub> | Reverse Recovery Charge                         | —  | 208  | 312  | nC    | di/dt = 100A/μs <sup>④⑤</sup>  |
| t <sub>on</sub> | Forward Turn-On Time                            | Intrinsic turn-on time is negligible (turn-on is dominated by L <sub>S</sub> +L <sub>D</sub> ) |      |      |       |  |

### Notes:

- ① Repetitive rating; pulse width limited by max. junction temperature. ( See fig. 11 )
- ② Starting T<sub>J</sub> = 25°C, L = 389μH  
R<sub>G</sub> = 25Ω, I<sub>AS</sub> = 28A. (See Figure 12)
- ③ I<sub>SD</sub> ≤ 28A, di/dt ≤ 220A/μs, V<sub>DD</sub> ≤ V<sub>(BR)DSS</sub>, T<sub>J</sub> ≤ 175°C.
- ④ Pulse width ≤ 400μs; duty cycle ≤ 2%.
- ⑤ Uses IRFZ46N data and test conditions.
- ⑥ This is a typical value at device destruction and represents operation outside rated limits.
- ⑦ This is a calculated value limited to T<sub>J</sub> = 175°C.
- ⑧ Calculated continuous current based on maximum allowable junction temperature. Package limitation current is 39A.

\*\* When mounted on 1" square PCB (FR-4 or G-10 Material ).

For recommended footprint and soldering techniques refer to application note #AN-994.

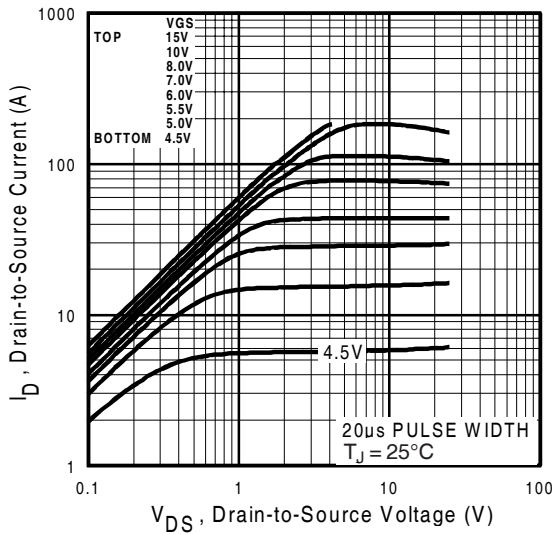


Fig 1. Typical Output Characteristics

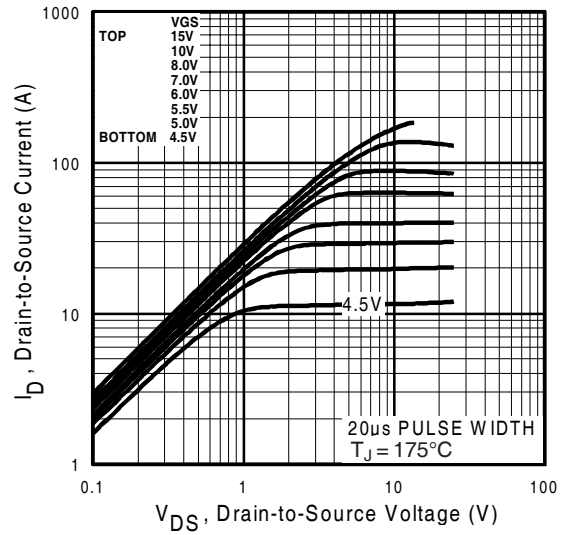


Fig 2. Typical Output Characteristics

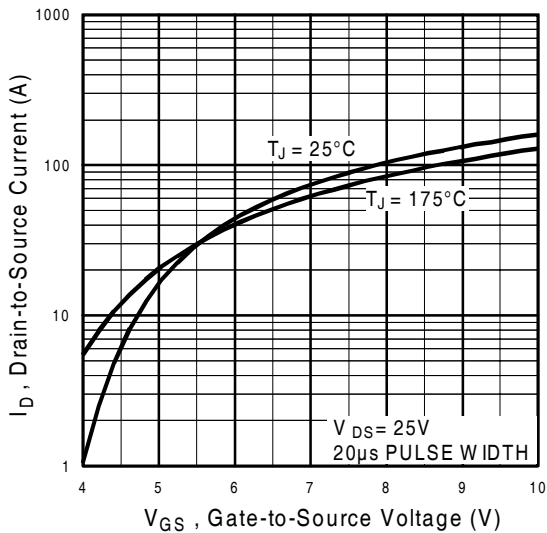


Fig 3. Typical Transfer Characteristics

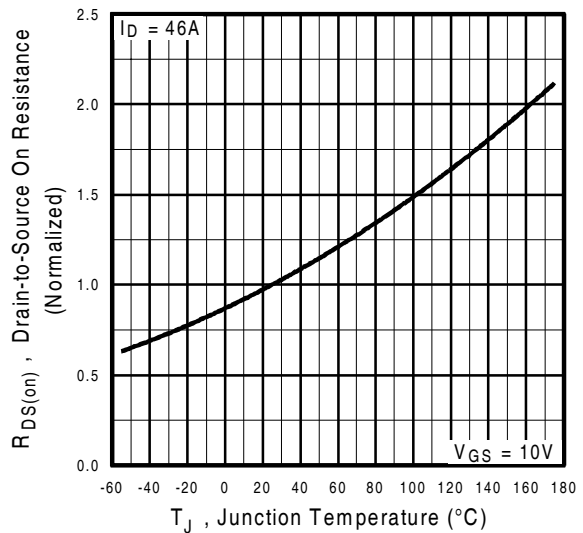
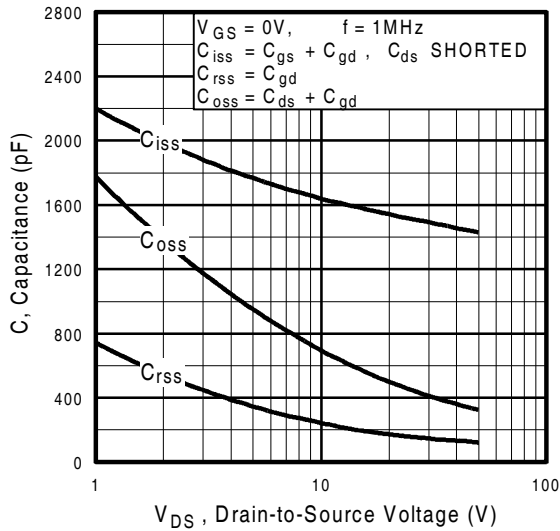
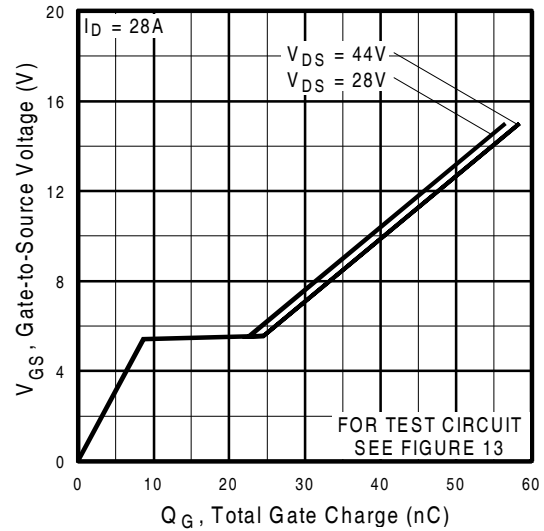


Fig 4. Normalized On-Resistance Vs. Temperature

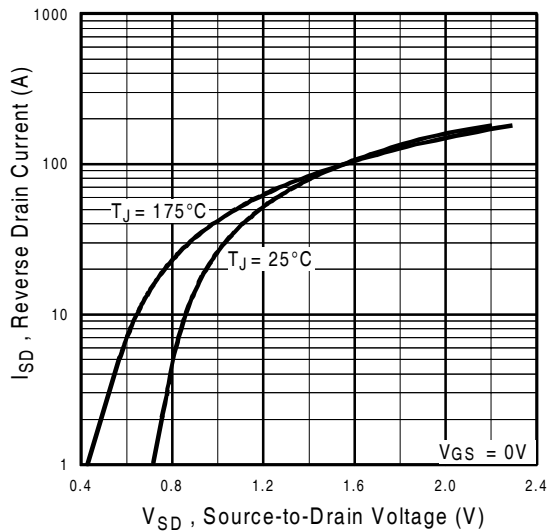
# IRFZ46NS/LPbF



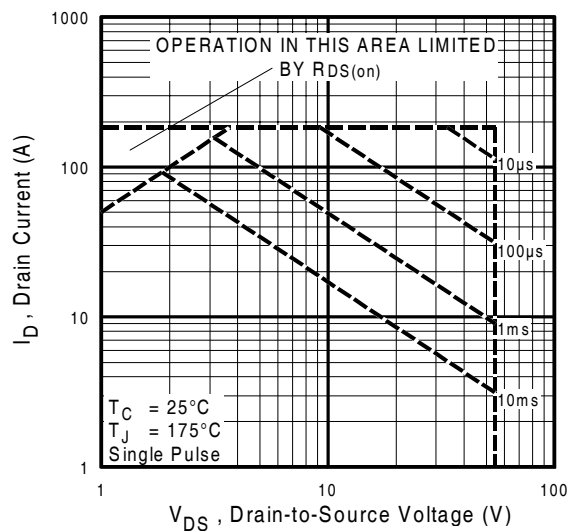
**Fig 5.** Typical Capacitance Vs. Drain-to-Source Voltage



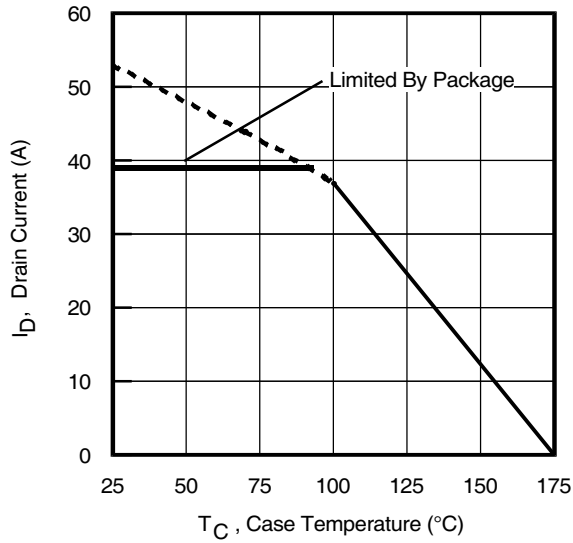
**Fig 6.** Typical Gate Charge Vs. Gate-to-Source Voltage



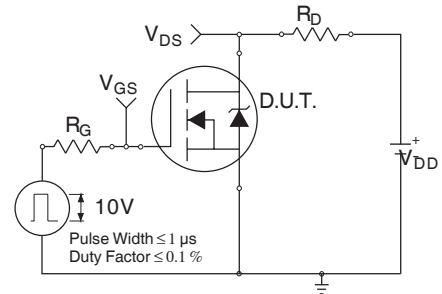
**Fig 7.** Typical Source-Drain Diode Forward Voltage



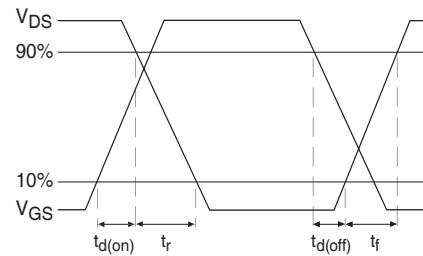
**Fig 8.** Maximum Safe Operating Area



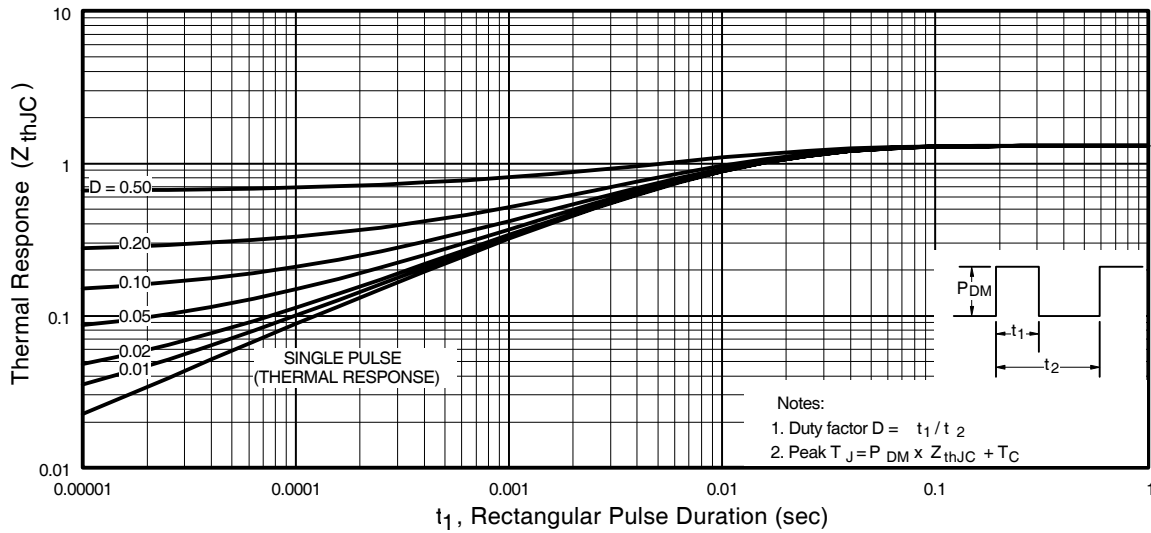
**Fig 9.** Maximum Drain Current Vs. Case Temperature



**Fig 10a.** Switching Time Test Circuit



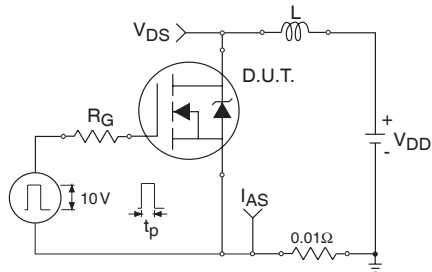
**Fig 10b.** Switching Time Waveforms



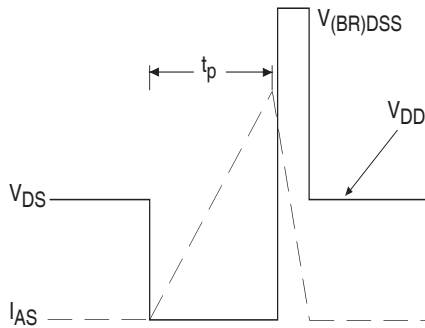
**Fig 11.** Maximum Effective Transient Thermal Impedance, Junction-to-Case

# IRFZ46NS/LPbF

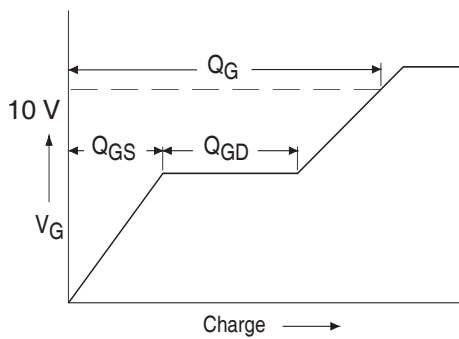
International  
**IRF** Rectifier



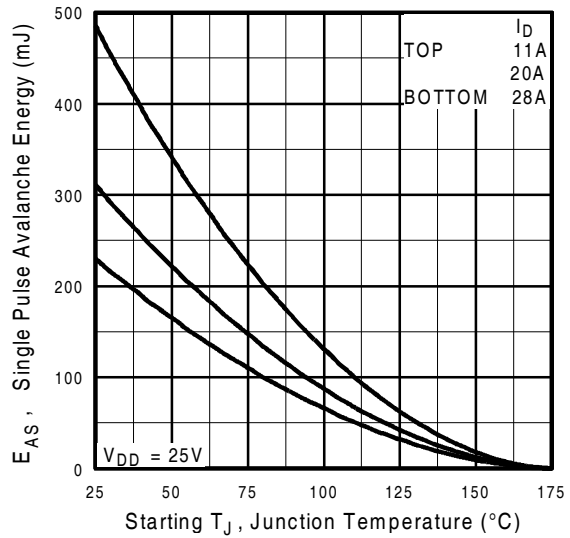
**Fig 12a.** Unclamped Inductive Test Circuit



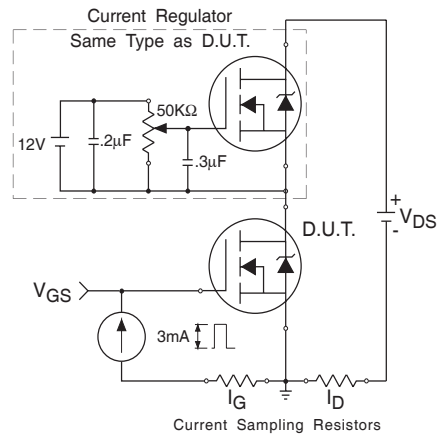
**Fig 12b.** Unclamped Inductive Waveforms



**Fig 13a.** Basic Gate Charge Waveform

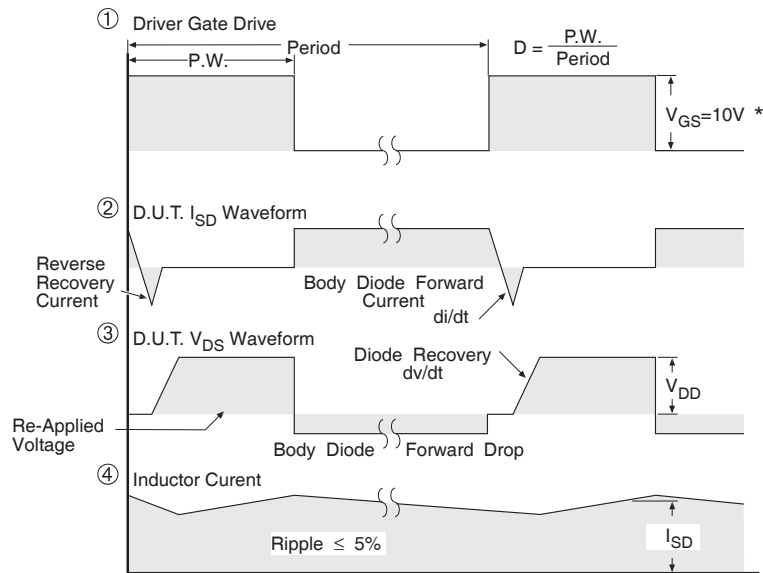
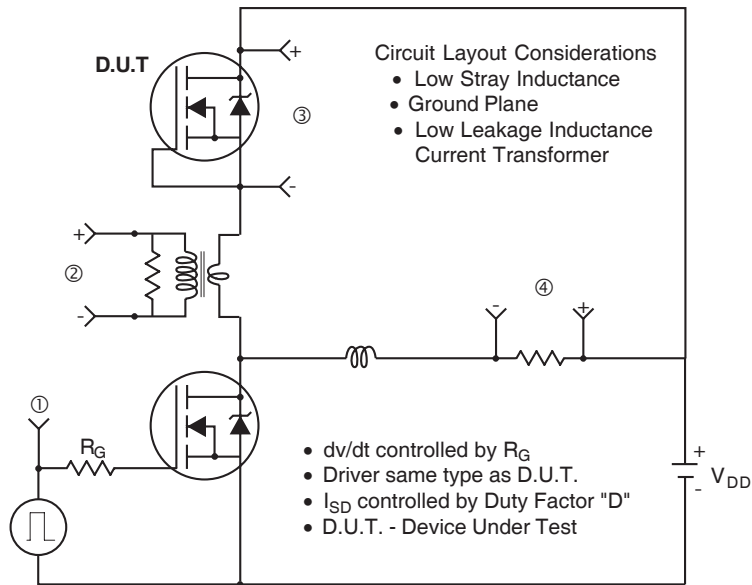


**Fig 12c.** Maximum Avalanche Energy Vs. Drain Current



**Fig 13b.** Gate Charge Test Circuit

## Peak Diode Recovery dv/dt Test Circuit



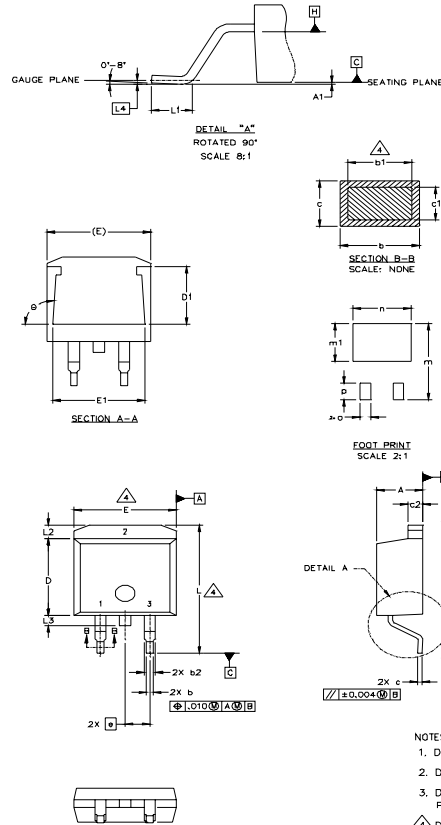
\*  $V_{GS} = 5V$  for Logic Level Devices

**Fig 14.** For N-Channel HEXFETS

# IRFZ46NS/LPbF

## D<sup>2</sup>Pak Package Outline

International  
**IRF** Rectifier



| SYMBOL | DIMENSIONS  |       |        |      | NOTES |
|--------|-------------|-------|--------|------|-------|
|        | MILLIMETERS |       | INCHES |      |       |
|        | MIN.        | MAX.  | MIN.   | MAX. |       |
| A      | 4.06        | 4.83  | .160   | .190 | 4     |
| A1     |             | 0.127 |        | .005 |       |
| b      | 0.51        | 0.99  | .020   | .039 |       |
| b1     | 0.51        | 0.89  | .020   | .035 |       |
| b2     | 1.14        | 1.40  | .045   | .055 | 4     |
| c      | 0.43        | 0.63  | .017   | .025 |       |
| c1     | 0.38        | 0.74  | .015   | .029 | 3     |
| c2     | 1.14        | 1.40  | .045   | .055 |       |
| D      | 8.51        | 9.65  | .335   | .380 | 3     |
| D1     | 5.33        |       | .210   |      |       |
| E      | 9.65        | 10.67 | .380   | .420 | 3     |
| E1     | 6.22        |       | .245   |      |       |
| e      | 2.54        | BSC   | .100   | BSC  |       |
| L      | 14.61       | 15.88 | .575   | .625 |       |
| L1     | 1.78        | 2.79  | .070   | .110 |       |
| L2     |             |       | 1.65   | .065 |       |
| L3     | 1.27        | 1.78  | .050   | .070 |       |
| L4     | 0.25        | BSC   | .010   | BSC  |       |
| m      | 17.78       |       | .700   |      |       |
| m1     | 8.89        |       | .350   |      |       |
| n      | 11.43       |       | .450   |      |       |
| o      | 2.08        |       | .082   |      |       |
| p      | 3.81        |       | .150   |      |       |
| theta  |             | 93°   |        | 93°  |       |

### LEAD ASSIGNMENTS

| HEXFET     | IGBTs, CoPACK | DIODES      |
|------------|---------------|-------------|
| 1.- GATE   | 1.- GATE      | 1.- ANODE * |
| 2.- DRAIN  | 2.- COLLECTOR | 2.- CATHODE |
| 3.- SOURCE | 3.- EMITTER   | 3.- ANODE   |

\* PART DEPENDENT.

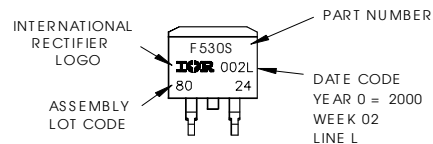
### NOTES:

1. DIMENSIONING AND TOLERANCING PER ASME Y14.5M-1994
2. DIMENSIONS ARE SHOWN IN MILLIMETERS [INCHES]
3. DIMENSION D & E DO NOT INCLUDE MOLD FLASH. MOLD FLASH SHALL NOT EXCEED 0.127 [.005"] PER SIDE. THESE DIMENSIONS ARE MEASURED AT THE OUTMOST EXTREMES OF THE PLASTIC BODY.
4. DIMENSION b1 AND c1 APPLY TO BASE METAL ONLY.
5. CONTROLLING DIMENSION: INCH.

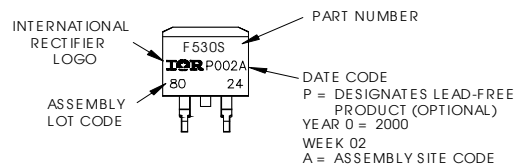
## D<sup>2</sup>Pak Part Marking Information (Lead-Free)

EXAMPLE: THIS IS AN IRF530S WITH  
LOT CODE 8024  
ASSEMBLED ON WW 02, 2000  
IN THE ASSEMBLY LINE "L"

Note: "P" in assembly line  
position indicates "Lead-Free"



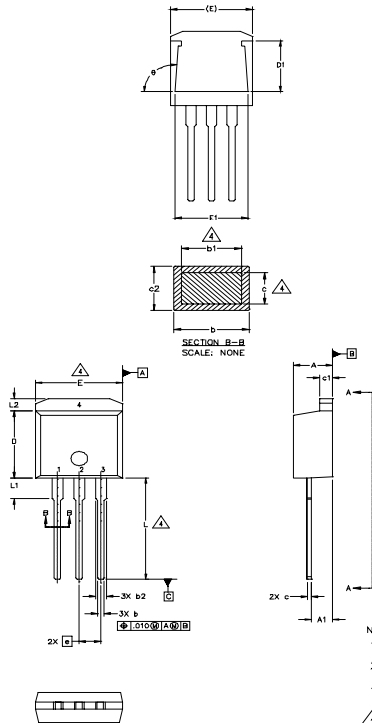
**OR**





## TO-262 Package Outline

Dimensions are shown in millimeters (inches)



| SYMBOL | DIMENSIONS  |       |        |      | FUNCTION |
|--------|-------------|-------|--------|------|----------|
|        | MILLIMETERS |       | INCHES |      |          |
|        | MIN.        | MAX.  | MIN.   | MAX. |          |
| A      | 4.06        | 4.83  | .160   | .190 | 4        |
| A1     | 2.03        | 2.92  | .080   | .115 |          |
| b      | 0.51        | 0.99  | .020   | .039 |          |
| b1     | 0.51        | 0.89  | .020   | .035 |          |
| b2     | 1.14        | 1.40  | .045   | .055 | 4        |
| c      | 0.38        | 0.63  | .015   | .025 |          |
| c1     | 1.14        | 1.40  | .045   | .055 |          |
| c2     | 0.43        | .063  | .017   | .029 |          |
| D      | 8.51        | 9.65  | .335   | .380 | 3        |
| D1     | 5.33        |       | .210   |      | 3        |
| E      | 9.65        | 10.67 | .380   | .420 |          |
| E1     | 6.22        |       | .245   |      |          |
| e      | 2.54        | BSC   | .100   | BSC  |          |
| L      | 13.46       | 14.09 | .530   | .555 |          |
| L1     | 3.56        | 3.71  | .140   | .146 |          |
| L2     |             | 1.65  |        | .065 |          |

### LEAD ASSIGNMENTS

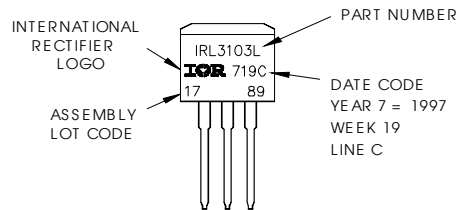
| HEXFET      | IGBT          |
|-------------|---------------|
| 1. - GATE   | 1 - GATE      |
| 2. - DRAIN  | 2 - COLLECTOR |
| 3. - SOURCE | 3 - EMITTER   |
| 4. - DRAIN  |               |

- NOTES:
1. DIMENSIONING AND TOLERANCING PER ASME Y14.5M-1994
  2. DIMENSIONS ARE SHOWN IN MILLIMETERS [INCHES]
  3. DIMENSION D & E DO NOT INCLUDE MOLD FLASH. MOLD FLASH SHALL NOT EXCEED 0.127 [005"] PER SIDE. THESE DIMENSIONS ARE MEASURED AT THE OUTMOST EXTREMES OF THE PLASTIC BODY.
  4. DIMENSION b1 AND c1 APPLY TO BASE METAL ONLY.
  5. CONTROLLING DIMENSION: INCH.

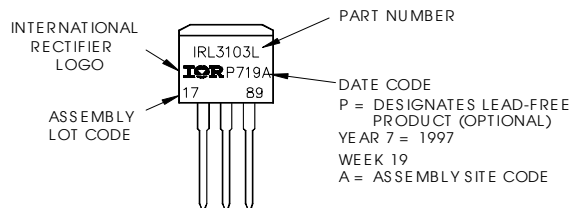
## TO-262 Part Marking Information

EXAMPLE: THIS IS AN IRL3103L  
LOT CODE 1789  
ASSEMBLED ON WW 19, 1997  
IN THE ASSEMBLY LINE "C"

Note: "P" in assembly line position indicates "Lead-Free"



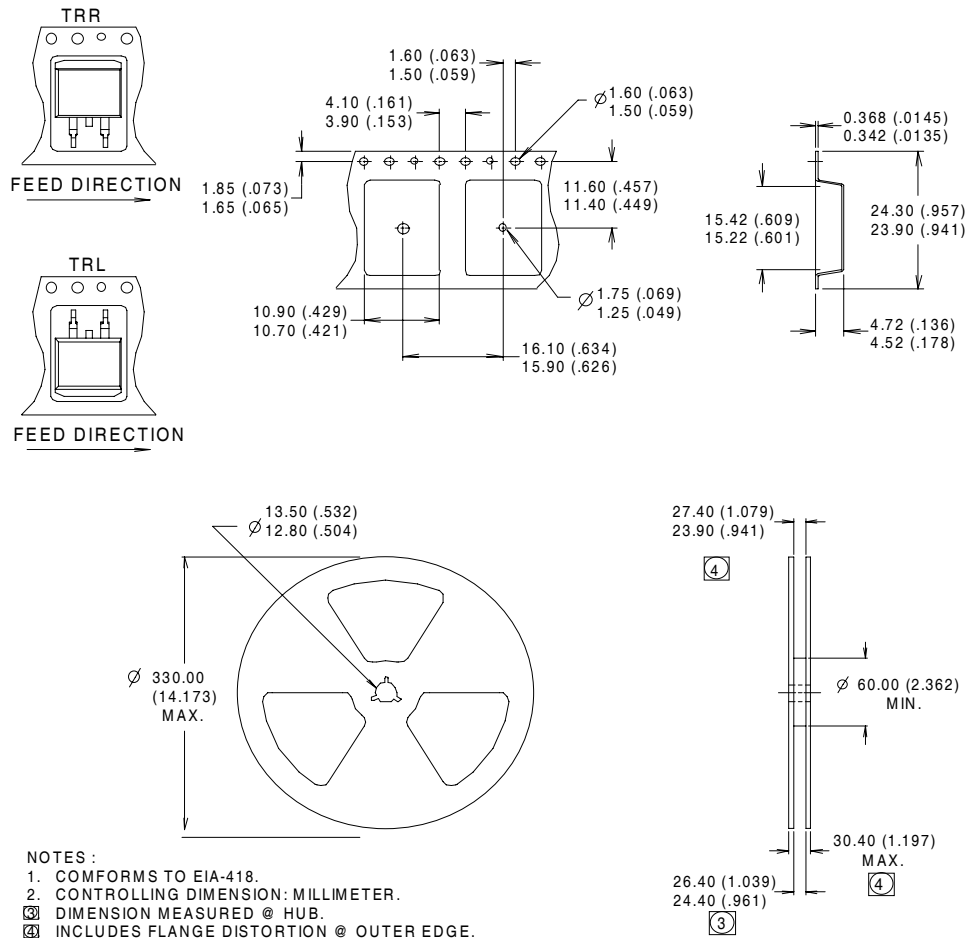
**OR**



# IRFZ46NS/LPbF

International  
**IR** Rectifier

## D<sup>2</sup>Pak Tape & Reel Information



Data and specifications subject to change without notice.  
This product has been designed and qualified for the industrial market.  
Qualification Standards can be found on IR's Web site.

International  
**IR** Rectifier

**IR WORLD HEADQUARTERS:** 233 Kansas St., El Segundo, California 90245, USA Tel: (310) 252-7105  
TAC Fax: (310) 252-7903

Visit us at [www.irf.com](http://www.irf.com) for sales contact information. 4/04  
[www.irf.com](http://www.irf.com)