

International Rectifier IRFK2D450, IRFK2F450

Isolated Base Power HEX-pak™ Assembly - Half Bridge Configuration

- High Current Capability.
- UL recognised E78996.
- Electrically Isolated Base Plate.
- Easy Assembly into Equipment.

Description

The HEX-pak™ utilizes the well-proven HEXFET™ die, combining low on-state resistance with high transconductance. These superior technology die are assembled by state of the art techniques into the TO-240 package, featuring 2.5kV rms isolation and solid M5 screw connections. The small footprint means the package is highly suited to power applications where space is a premium. Available in two versions, IRFK.D... for fast switching and IRFK.F... for oscillation sensitive applications.

$$V_{DS} = 500V$$

$$R_{DS(on)} = 200m\Omega$$

$$I_D = 22A$$

Absolute Maximum Rating

	Parameter	Max.	Units
$I_D @ T_C=25^\circ C$	Continuous Drain Current	22	A
$I_D @ T_C=100^\circ C$	Continuous Drain Current	14	A
I_{DM}	Pulse Drain Current	88	A ①
$P_D @ T_C=25^\circ C$	Maximum Power Dissipation	500	W
V_{GS}	Gate-to-Source Voltage	20	V
V_{INS}	R.M.S. Isolation Voltage, circuit to base	2.5	KV
T_J	Operating Junction Temperature Range	-40 to 150	°C
T_{STG}	Storage Temperature Range	-40 to 150	°C

Thermal and Mechanical Specifications

	Parameter	Min.	Typ.	Max.	Units
R_{thJC}	Junction-to-Case	-	-	0.25	K/W ②
R_{thCS}	Case-to-Sink, smooth & greased surface	-	0.1	-	K/W
T	Mounting Torque +10%				③
	HEXpak to Heatsink	-	5	-	Nm
	Busbar to HEXpak	-	3	-	Nm
wt	Approximate Weight	-	140	-	g
		-	5	-	oz

Notes:

- ① - Repetitive Rating: Pulse width limited by maximum junction temperature see figure 8.
- ② - Per Module.
- ③ - A mounting compound is recommended and the torque should be rechecked after a period of three hours to allow for the spread of the compound.

IRFK2D450, IRFK2F450



Electrical Characteristics @ $T_J = 25^\circ\text{C}$ (Unless otherwise specified)

	Parameter	Min.	Typ.	Max.	Units	Test Conditions	
B_{VDSS}	Drain-to-Source Breakdown voltage	500	-	-	V	$V_{GS}=0V, I_D=1.0mA$	
$R_{DS(on)}$	Static Drain-to-Source On-State Resistance	-	160	200	$m\Omega$	$V_{GS}=10V, I_D=14A$	
$I_{D(on)}$	On-State Drain Current	22	-	-	A	$V_{DS} > I_{D(on)} \times R_{DS(on)}^{max}, V_{GS}=10V$	
$V_{GS(th)}$	Gate Threshold Voltage	2.0	-	4.0	V	$V_{DS}=V_{GS}, I_D=1.0mA$	
g_{fs}	Forward Transconductance ④	16	26	-	S	$V_{DS} > 50V, I_D=14A$	
I_{DSS}	Zero Gate Voltage Drain Current	-	-	0.5	mA	$V_{DS}=V_{DS}^{max}, V_{GS}=0V$	
		-	-	2.0	mA	$V_{GS}=10V, T_C=125^\circ\text{C}, V_{DS}=V_{DS}^{max} \times 0.8$	
I_{GSS}	Gate-to-Source Leakage Forward	-	-	200	nA	$V_{GS}=20V$	
I_{GSS}	Gate-to-Source Leakage Reverse	-	-	-200	nA	$V_{GS}=-20V$	
Q_g	Total Gate Charge	-	225	260	nC	$I_D=22A, V_{GS}=10V,$	
Q_{gs}	Gate-to-Source Charge	-	22	34	nC	$V_{DS}=V_{DS}^{max} \times 0.8$	
Q_{gd}	Gate-to-Drain ("Miller") Charge	-	86	128	nC		
$t_{d(on)}$	Turn-on Delay Time	IRFK2D450	-	40	-	ns	$V_{DD}=210V, I_D=14A,$ $V_{GS}=10V,$ $R_{SOURCE}=3.3\Omega$
		IRFK2F450	-	45	-	ns	
t_r	Rise Time	IRFK2D450	-	50	-	ns	
		IRFK2F450	-	65	-	ns	
$t_{d(off)}$	Turn-off Delay Time	IRFK2D450	-	190	-	ns	
		IRFK2F450	-	250	-	ns	
t_f	Fall Time	IRFK2D450	-	40	-	ns	
		IRFK2F450	-	65	-	ns	
L_{DS}	Drain-to-Source Inductance	-	18	-	nH		
C_{iss}	Input Capacitance	-	5.5	-	nF	$V_{GS}=0V, V_{DS}=25V,$	
C_{oss}	Output Capacitance	-	1.2	-	nF	$f=1.0MHz$	
C_{rss}	Reverse Transfer Capacitance	-	0.35	-	nF		
	Linear Derating Factor	-	-	4	W/K		

Source-Drain Diode Ratings and Characteristics

	Parameter	Min.	Typ.	Max.	Units	Test Conditions
I_S	Continuous Source Current (Body Diode)	-	-	22	A	
I_{SM}	Pulsed Source Current (Body Diode)	-	-	80	A	
V_{SD}	Diode Forward Voltage	-	-	1.4	V	$V_{GS}=0V, I_S=22A, T_C=25^\circ\text{C}$
t_{rr}	Reverse Recovery Time	280	580	1200	ns	$di/dt=200A/\mu s, T_J=150^\circ\text{C}$
Q_{rr}	Reverse Recovered Charge	6.4	13.5	30.0	μC	$I_S=22A$

Notes:

④ - Pulse Width $\leq 300\mu s$; Duty cycle $\leq 2\%$.



IRFK2D450, IRFK2F450

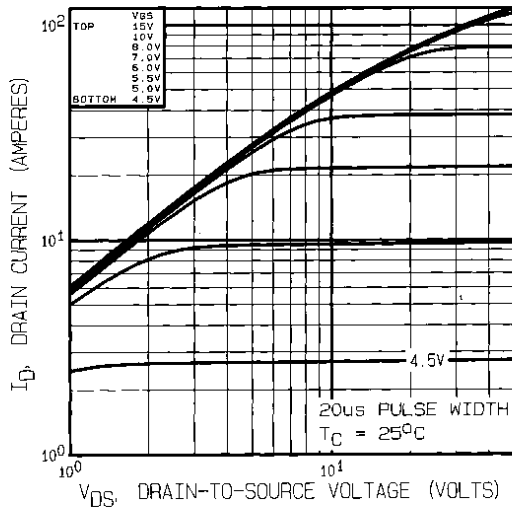

Fig 1. Typical Output Characteristics, $T_C = 25^\circ\text{C}$

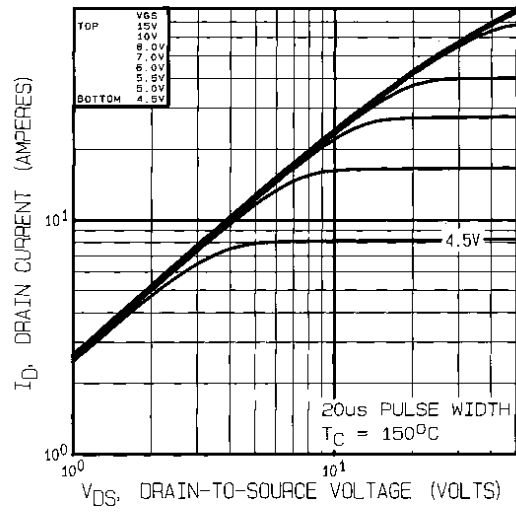

Fig 2. Typical Output Characteristics, $T_C = 150^\circ\text{C}$

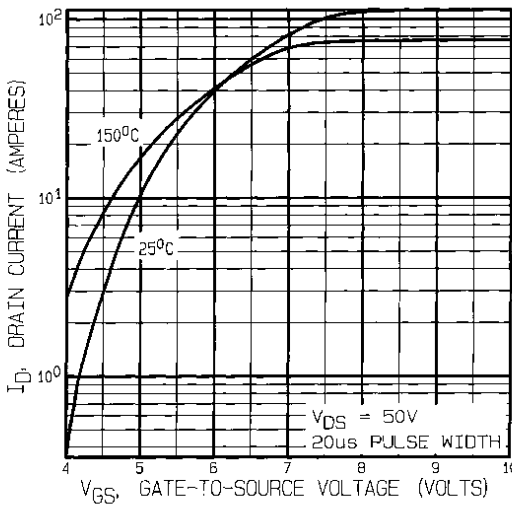

Fig 3. Typical Transfer Characteristics

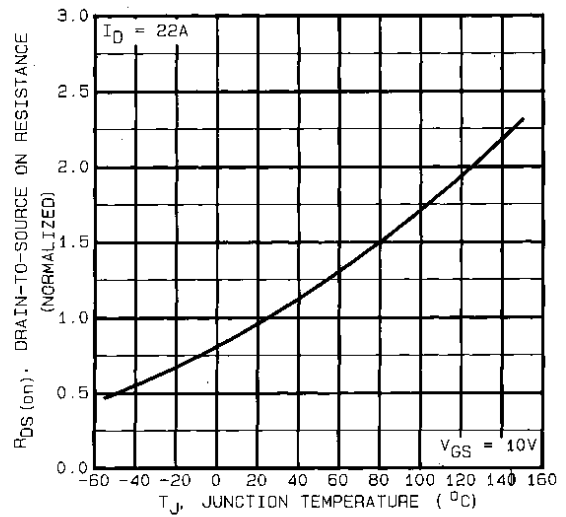

Fig 4. Normalized On-Resistance Vs. Temperature

IRFK2D450, IRFK2F450

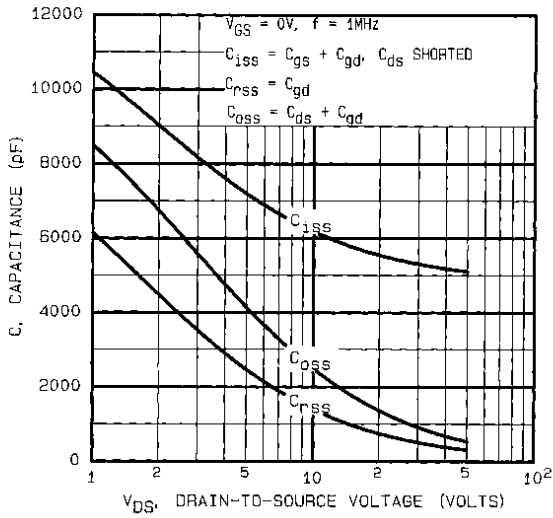

Fig 5. Typical Capacitance Vs. Drain-to-Source Voltage

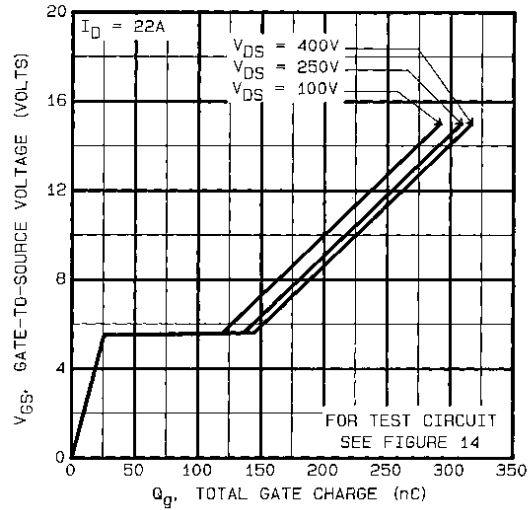

Fig 6. Typical Gate Charge Vs. Gate-to-Source Voltage

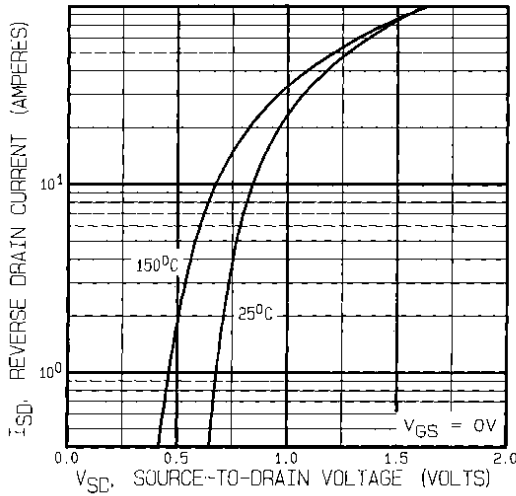

Fig 7. Typical Source-Drain Diode Forward Voltage

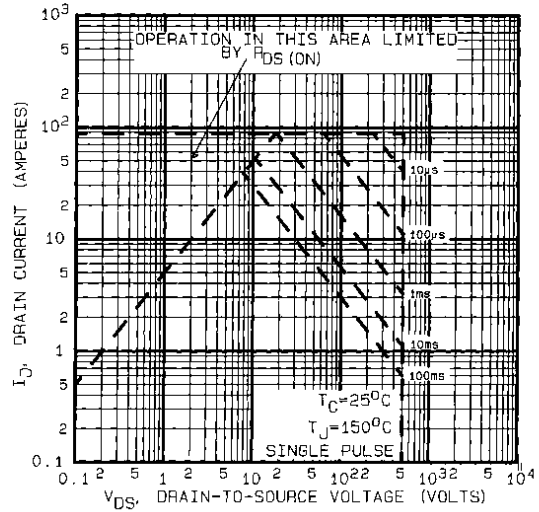

Fig 8. Maximum Safe Operating Area



IRFK2D450,IRFK2F450

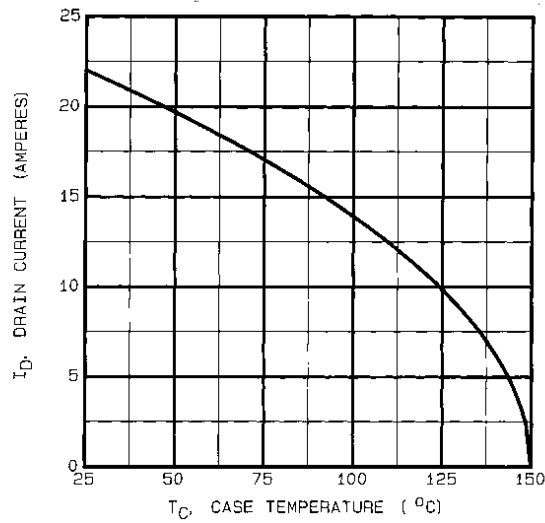

Fig 9. Maximum Drain Current Vs. Case Temperature

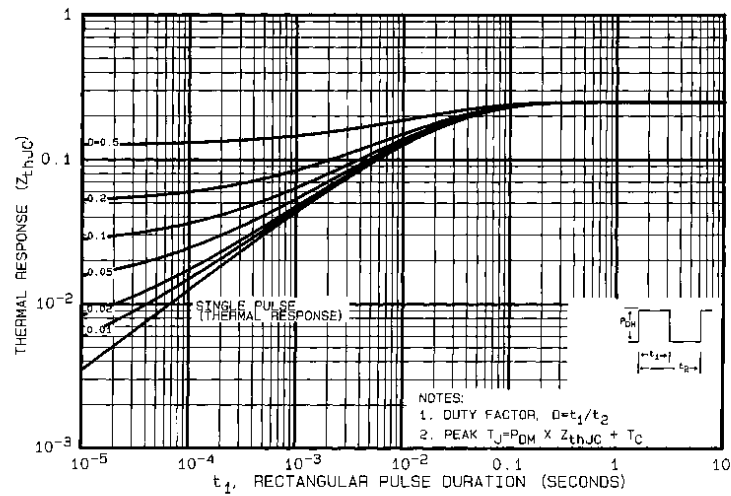

Fig 10. Maximum Effective Transient Thermal Impedance, Junction-to-Case

IRFK2D450,IRFK2F450

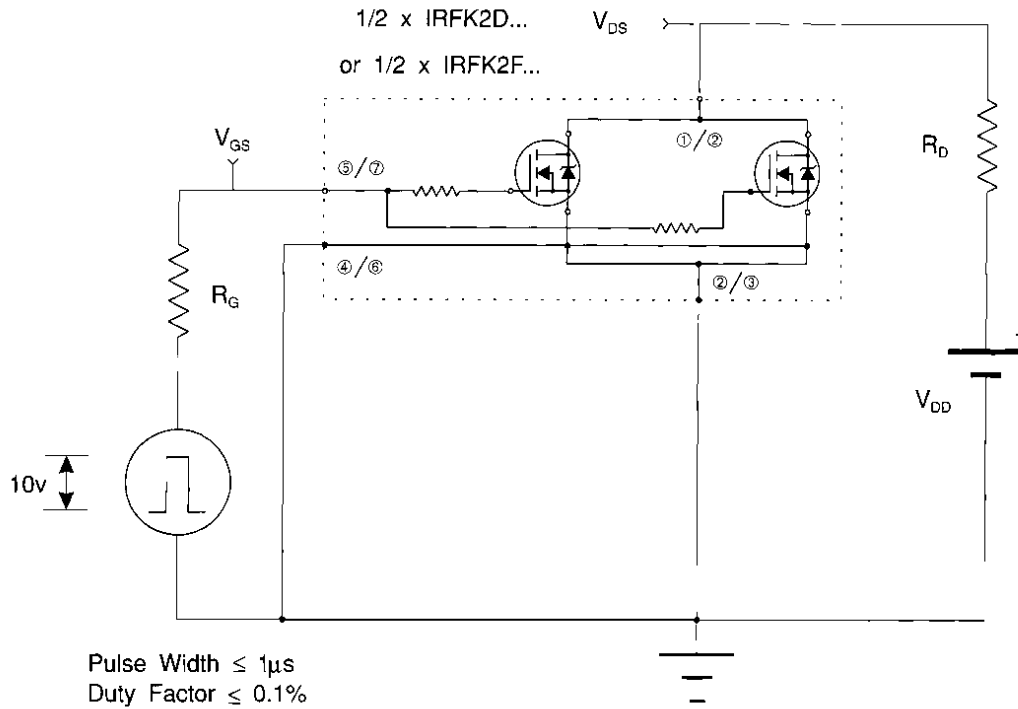

Fig 11a. Switching Time Test Circuit

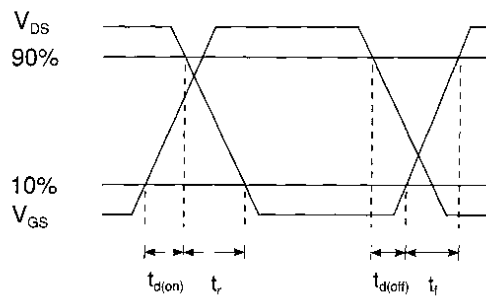
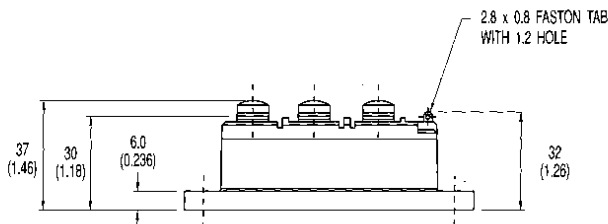
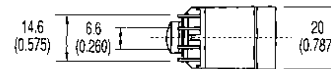
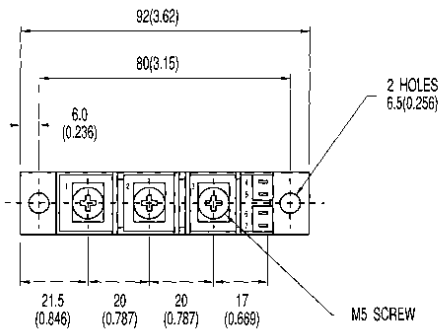
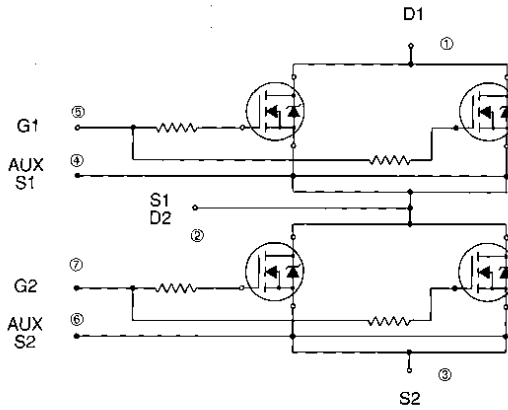

Fig 11b. Switching Time Waveforms



IRFK2D450,IRFK2F450

Circuit Configuration and Outline



NOTE:
DEVICE IS SUPPLIED WITH
AUXILIARY LEADS 200(7.87) LONG

All dimensions in millimetres (inches)

IRFK2D450,IRFK2F450



Part Numbering

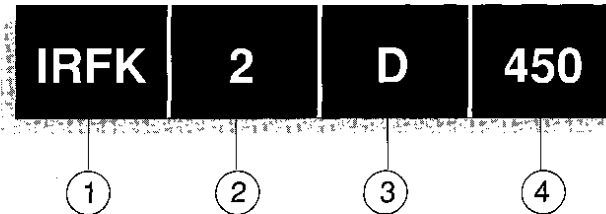

1. - HEX-pak Module.
2. - Number of arms of bridge.
3. - D - Fast switching.
- F - Oscillation resistant for sensitive applications.
4. - Voltage code:-
 - 054 - 60V
 - 150 - 100V
 - 250 - 200V
 - 350 - 400V
 - 450 - 500V
 - C50 - 600V

WORLD HEADQUARTERS: 233 Kansas St., **EL SEGUNDO**, California 90245, USA. Tel:(213) 772-2000. Tlx:664464. Fax:(213) 772-9028
EUROPEAN HEADQUARTERS: Hurst Green, **OXTED**, Surrey RH8 9BB, UK. Tel:(0883) 713215. Tlx:95219. Fax:(0883)714234.

CANADA: 101 Bentley St., Markham, **ONTARIO L3R 3L1**. Tel:(416)475-1897. Tlx:06-966-650. Fax:(416)475-8801
CZECHOSLOVAKIA: Macurova 19/1565, Box 30, 149 00 **PRAGUE**. Tel:(2) 792 6831. Fax:(2) 792 6831.
DENMARK: P.O. Box 70, Krogshøjvej 51, DK-2880 **BAGSVAERD**. Tel: (45) 44 37 71 50. Fax (45) 44 37 71 52.
FRANCE: 123 Rue de Petit Vaux, 91360 **EPINAY sur ORGE**. Tel:(1)64.54.83.29. Tlx:600943. Fax:(1)64.54.83.30.
FINLAND: **Billskogsvägen** 19, 02580 Sjundeå St. Tel:(0) 262 8144. Fax:(0) 262 8150.
GERMANY: Saalburgstr. 157, D-6380 **BAD HOMBURG**. Tel:(61)72 37066. Tlx:410404. Fax:(61)72 37065.
HUNGARY: Szent Istvan Park 15, H-1137 **BUDAPEST**. Tel:(1) 1298 822. Fax:(1) 1298 822.
HONG KONG: 202 Peter Building, 60 Queens Road Central, **HONG KONG**. Tel:(85) 252 36355. Fax: (85) 284 52908.
ITALY: Via Liguria 49, 10071 Borgaro, **TORINO**. Tel:(011)470 14 84. Tlx:221257. Fax:(011)470 42 90.
Via Zucca 8, 20017 Rho **MILANO**. Tel:(02)93 50 36 50. Fax:(02)93 50 36 55.
Via Arno 1, 40139 **BOLOGNA**. Tel:(051)49 33 07. Fax:(051)49 54 80.
INDIA: 31 Greenacre, 5 Union Park, Khar (W), **BOMBAY** 400 052. Tel:(022)535026/533779/540242. Tlx:011-71481.
JAPAN: K & H Bldg. 2F, 3-30-4 Nishi-Ikebukuro, Toshima-ku, **TOKYO**, Japan 171. Tel:(03)983 0641. Fax:(03)983 0642.
SINGAPORE: HEX 10-01 Fortune Centre, 190 Middle Road, **SINGAPORE** 0718. Tel:(65)336 3922/337 4695/336 6286. Fax: (65)337 4692.
SWEDEN: Box: 86, S-162 12 Vallingby 1, **STOCKHOLM**. Tel:(08)870035. Fax:(08)874242.
SWITZERLAND: **CH-8032 ZURICH**, Kirchenweg 5. Tel:(01)386 8702/8686. Fax:(01)383 5108/2379.
U.S.A.:
Central Zone: 2401 Plum Grove Road, Suite 111, **PALATINE**, IL60067. Tel:(312)397-0002. Fax:(312)397-0114.
Eastern Zone: 71 Grand Avenue, **PALISADES PARK**, NJ07650. Tel:(201)943-4554. Fax:(201)943-5754.
Southern Zone: 800 Office Plaza Blvd., Suite 401, **KISSIMMEE**, FL32743. Tel:(407)933-2383. Fax:(407)933-2293.
Western Zone: 222 Kansas Street, **EL SEGUNDO**, CA90245. Tel:(213)607-8886. Fax:(213)640-6533.

Sales Offices, Agents and Distributors in Major Cities throughout the World.

In the interest of product improvement INTERNATIONAL RECTIFIER reserves the right to change specifications at any time without notice.

MJW/1/92