

### SpiceLED<sup>TM</sup>

Like spice, its diminutive size is a stark contrast to its standout performance in terms of brightness, durability and reliability. Despite being the smallest in size yet the SpiceLED<sup>TM</sup> packs a powerful performance and is a highly reliable design device. Its versatility enables its application in automotive appliances, key-pad illumination, hand-held devices such as PDAs, notebooks, compact back-lighting applications, consumer appliances, office equipment, audio and video equipment.



### Features:

- > High brightness surface mount LED.
- > Super wide viewing angle of 160°.
- > Equivalent to 0805 package outline. Copper lead-frame construction.
- > Qualified according to JEDEC moisture sensitivity Level 2.
- > Compatible to both IR reflow soldering and TTW soldering.
- > Environmental friendly; RoHS compliance.



### Applications:

- > Automotive: interior applications, eg: switches, telematics, climate control system, dashboard, etc.
- > Consumer Appliances: LCD illumination as in PDAs, LCD TV.
- > Communication: indicator and backlight in mobilephone.
- > Display: full color display video notice board.
- > Industry: white goods (eg: Oven, microwave, etc.).



Part Ordering Number	Chip Technology / Color	Viewing Angle°	Luminous Intensity @ IF = 2mA IV (mcd)
<b>SMT-SLD-L2N1-1</b>	<b>InGaN</b>	<b>160</b>	<b>14.00 - 35.50</b>
• SMT-SLD-L2	True Green, 525 nm		14.00 - 18.00
• SMT-SLD-M1			18.00 - 22.40
• SMT-SLD-M2			22.40 - 28.50
• SMT-SLD-N1			28.50 - 35.50
<b>SMB-SLD-H2K1-1</b>	<b>InGaN</b>	<b>160</b>	<b>3.55 - 9.00</b>
• SMB-SLD-H2	Blue, 470 nm		3.55 - 4.50
• SMB-SLD-J1			4.50 - 5.60
• SMB-SLD-J2			5.60 - 7.20
• SMB-SLD-K1			7.20 - 9.00

NOTE

1. All part number above comes in a quantity of 3000 units per reel.
2. Other luminous intensity groups are also available upon request
3. Luminous intensity is measured with an accuracy of  $\pm 11\%$ .
4. Wavelength binning is carried for all units as per the wavelength-binning table. Only one wavelength group is allowed for each reel.

**Wavelength Grouping**

Color	Group	Wavelength distribution (nm)
SMT; True Green	Full	520 - 536
	W	520 - 524
	X	524 - 528
	Y	528 - 532
	Z	532 - 536
SMB; Blue	Full	464 - 476
	W	464 - 468
	X	468 - 472
	Y	472 - 476

Dominant wavelength is measured with an accuracy of  $\pm 1\text{nm}$ .

### Electrical Characteristics at Ta=25°C

Part Number	Vf @ If = 2mA			Vf @ If = 10mA	Vr @ Ir = 10uA
	Min. (V)	Typ. (V)	Max. (V)	Typ. (V)	Min. (V)
SMx-SLD	2.6	2.8	3.0	3.0	5

Forward voltage, Vf is measured with an accuracy of ± 0.1 V.

### Absolute Maximum Ratings

	Maximum Value	Unit
DC forward current	15	mA
Peak pulse current; (tp ≤ 10μs, Duty cycle = 0.1)	100	mA
Reverse voltage; Ir <sub>max</sub> = 10μA	5	V
ESD threshold (HBM)	1000	V
LED junction temperature	110	°C
Operating temperature	-40 ... +100	°C
Storage temperature	-40 ... +100	°C
Power dissipation (at room temperature)	45	mW

### Material

Material	
Lead-frame	Cu Alloy With NiPdAu Plating
Package	High Temperature Resistant Epoxy Resin

Note: product is Pb free

Intensity Vs Forward Current (True Green)

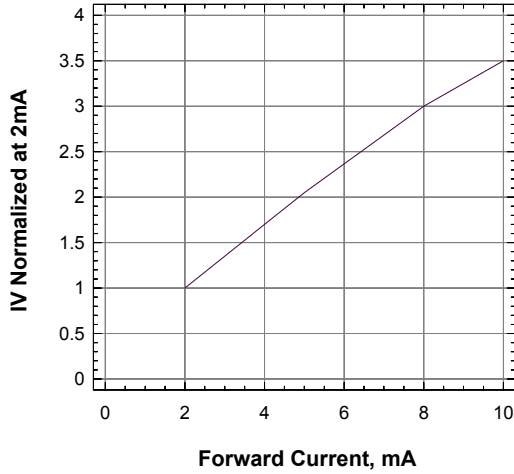

Intensity Vs Forward Current (Blue)

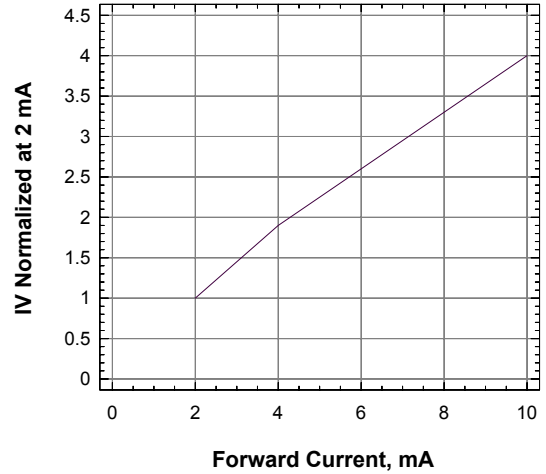

Forward Current Vs Forward Voltage

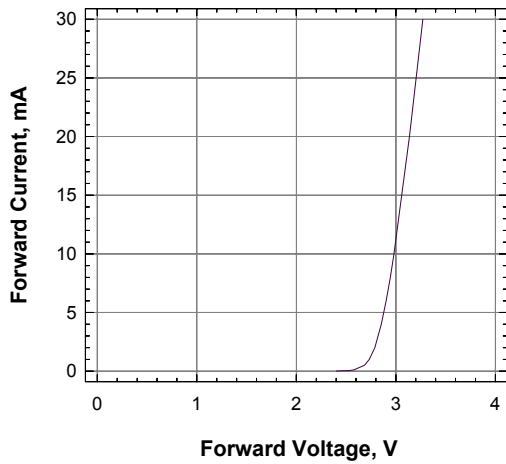

Maximum Current Vs Ambient Temperature

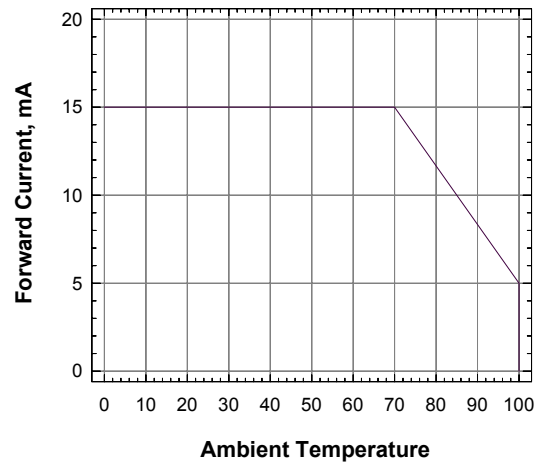

Relative Intensity Vs Wavelength

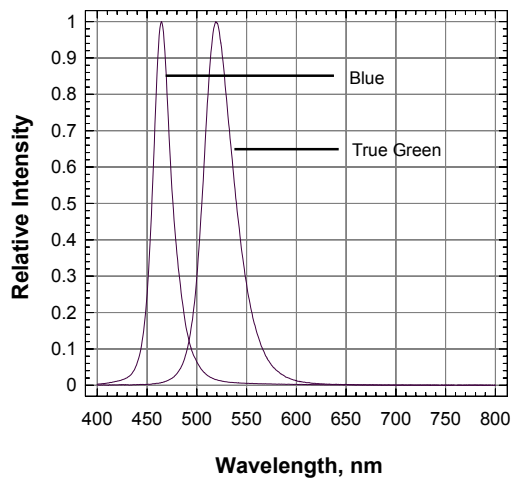

Dominant Wavelength Vs Forward Current

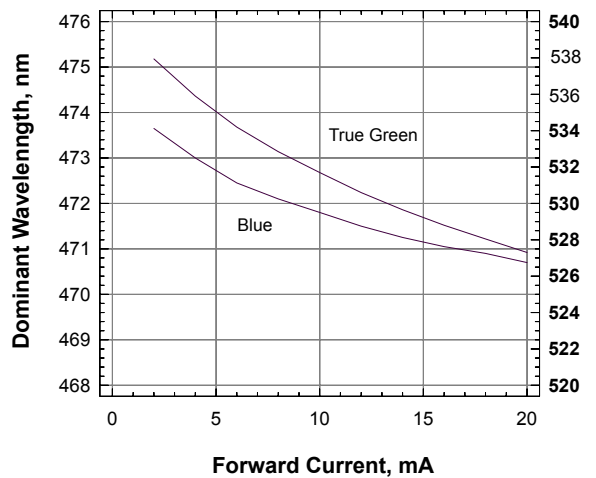

**Radiation Pattern**

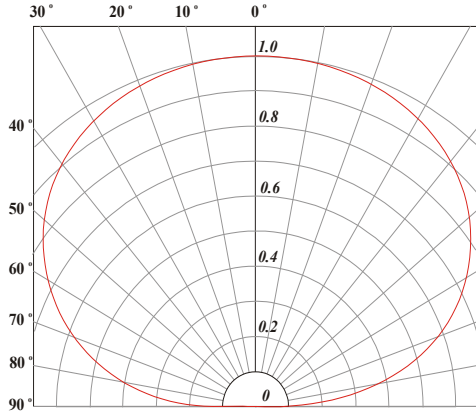

**SpiceLED™ • InGaN M-Spice : SMx-SLD Package Outlines**

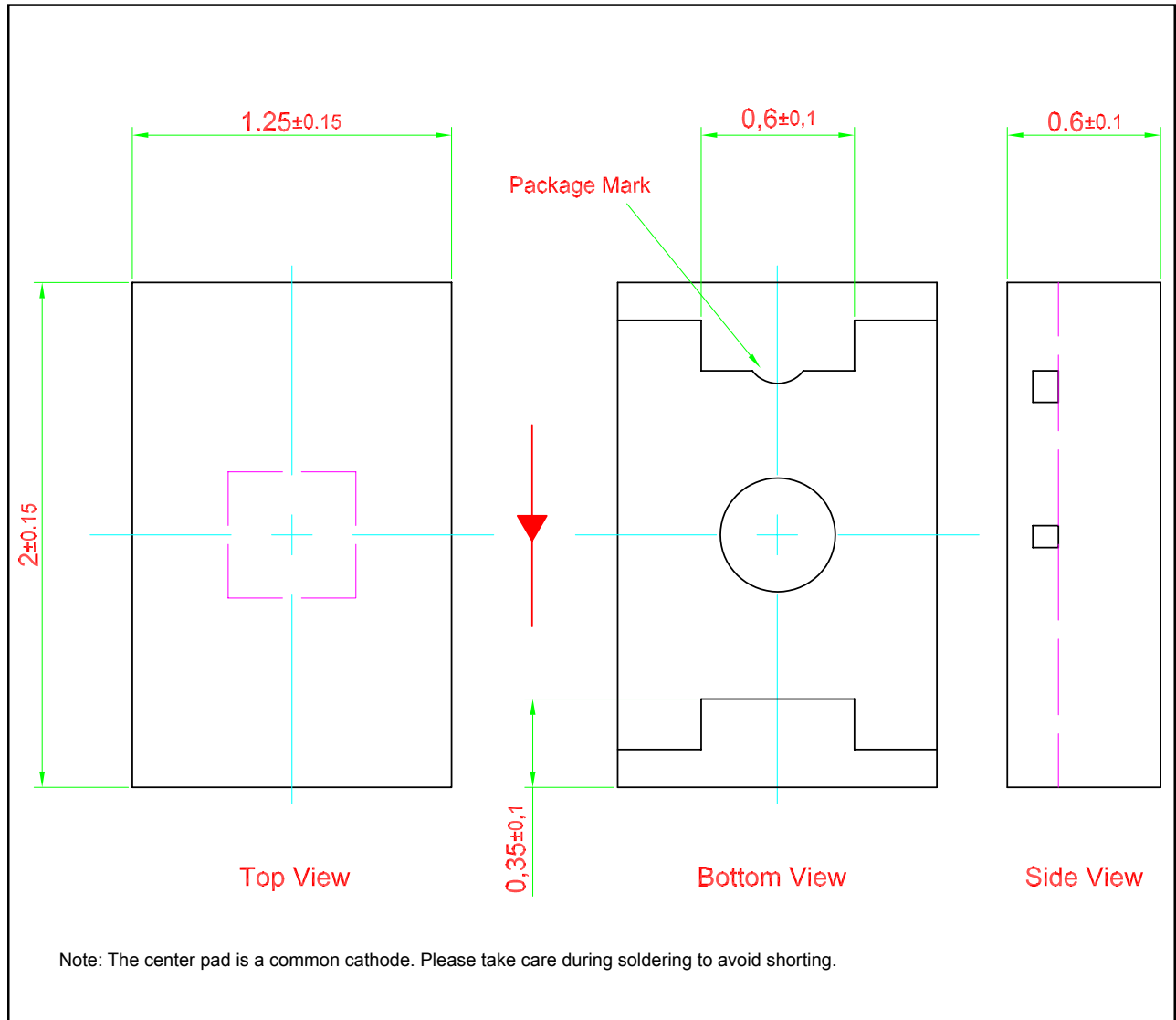

## Recommended Solder Pad

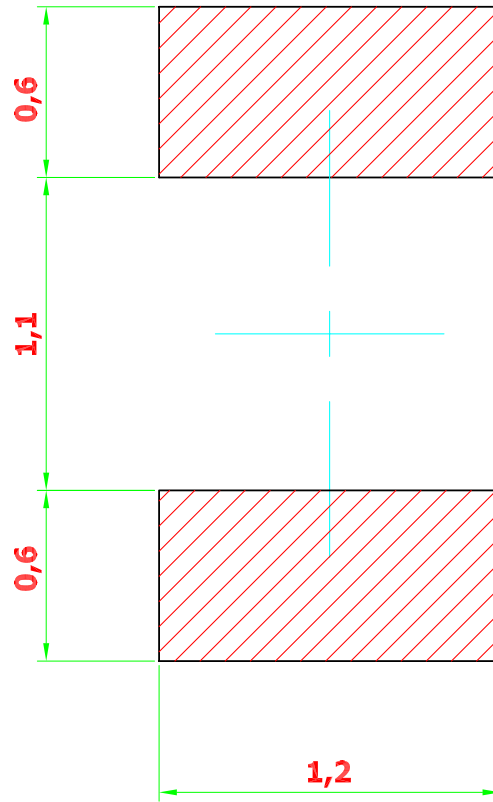

Note: Component is based on a new package platform, which features "Bottom Only Terminations". Solder joints are only formed at the bottom of the component and solder fillet will not be observable as the sides of the component.

## Taping and orientation

- Reels come in quantity of 3000 units.
- Reel diameter is 180 mm.

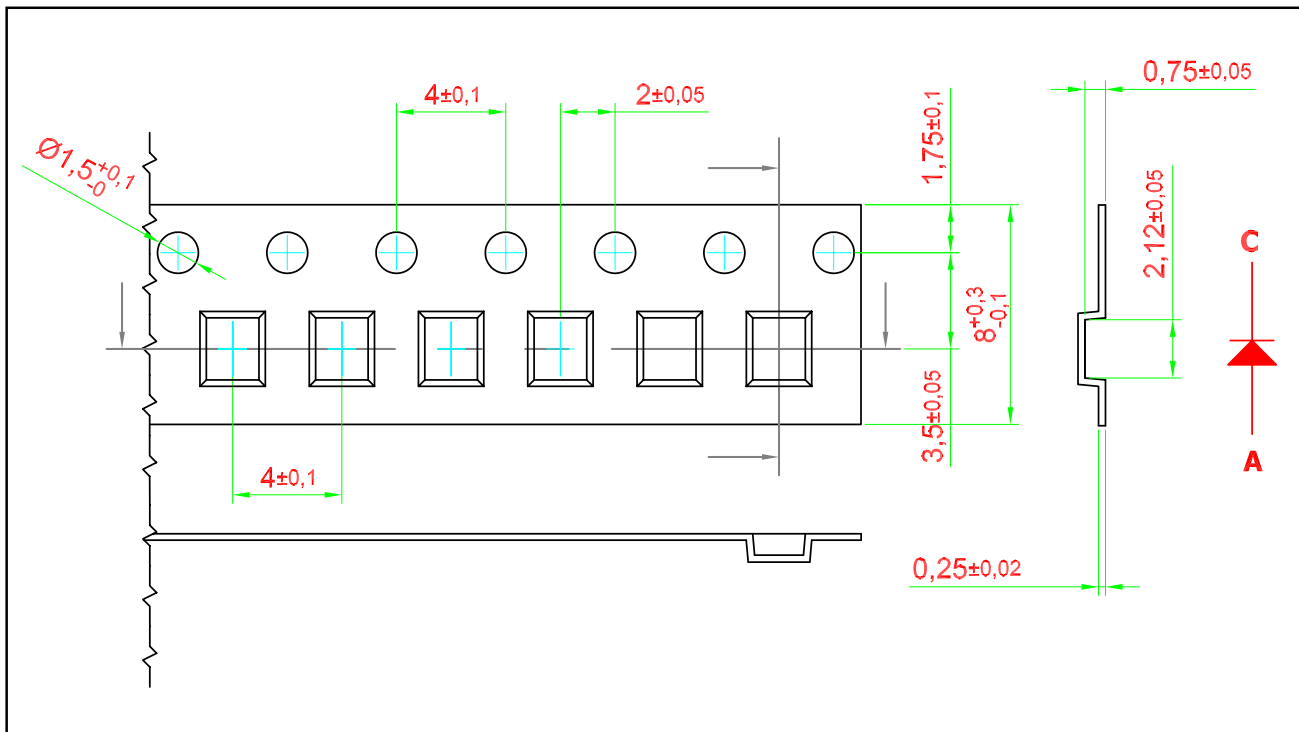



### Packaging Specification

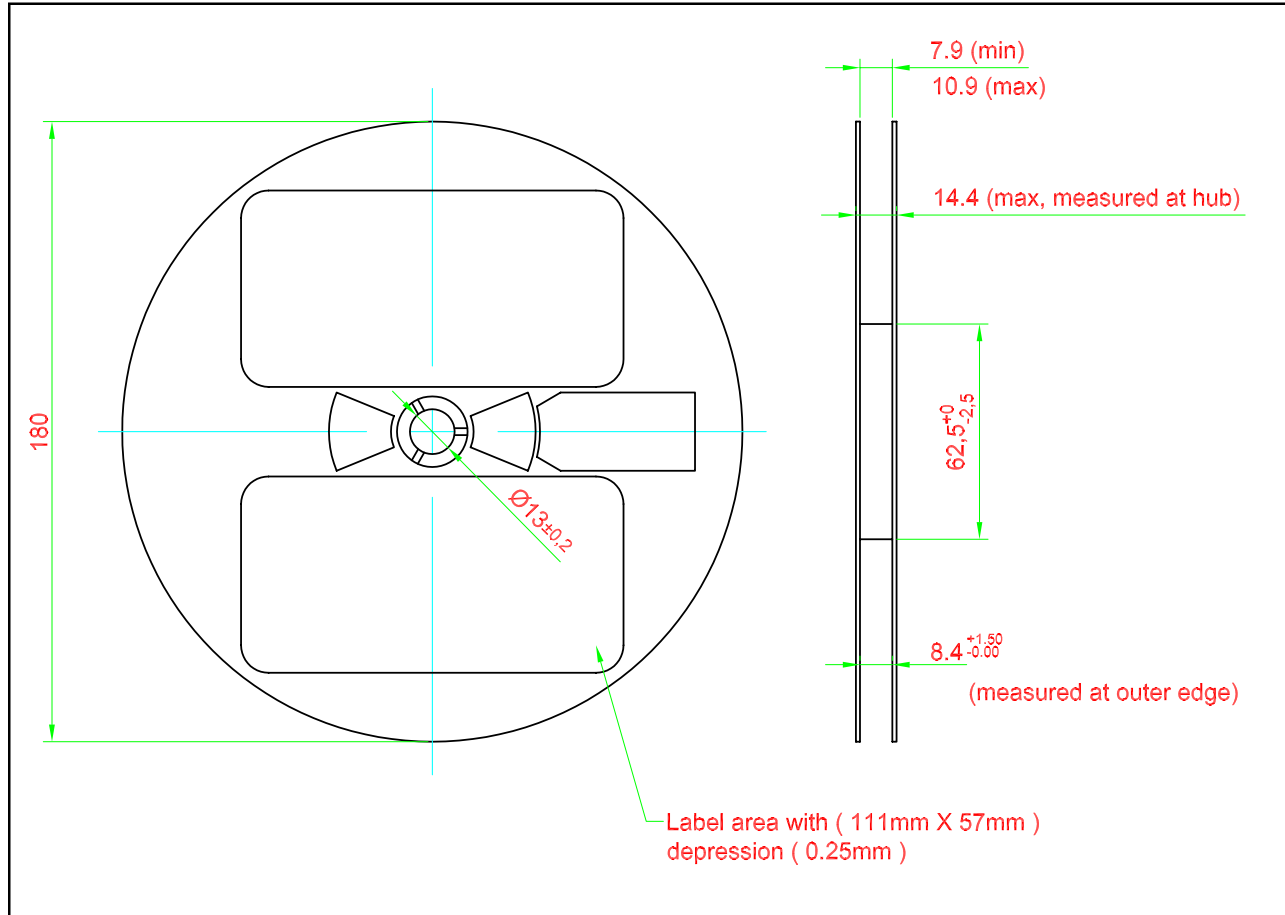

**Packaging Specification**

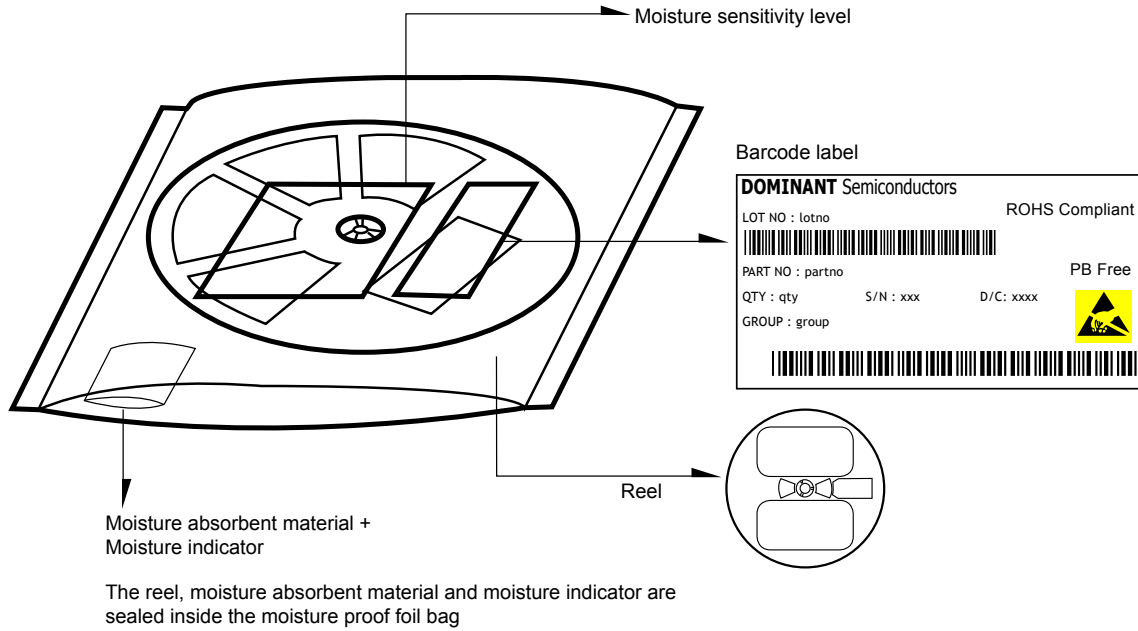

	Average 1pc SpiceLED	1 completed bag (3000pcs)
Weight (gram)	0.001	140 ± 10

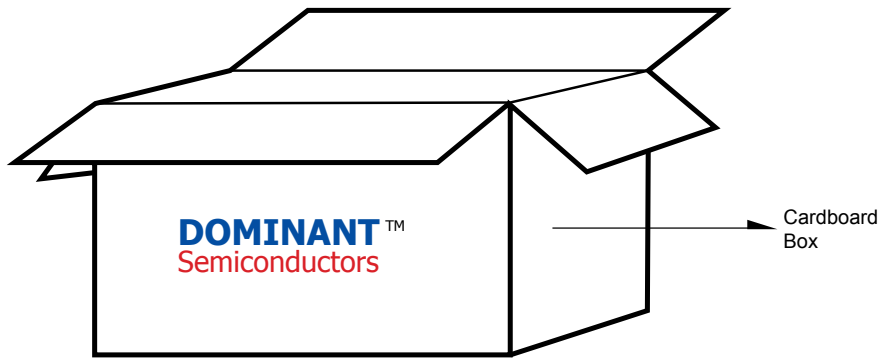

**For SpiceLED™**

Cardboard Box Size	Dimensions (mm)	Empty Box Weight (kg)	Reel / Box	Quantity / Box (pcs)
Small	300 x 250 x 250	0.58	15 reels MAX	45,000 MAX
Large	416 x 516 x 476	1.74	55 reels MAX	165,000 MAX

**Recommended Sn-Pb IR-Reflow Soldering Profile**

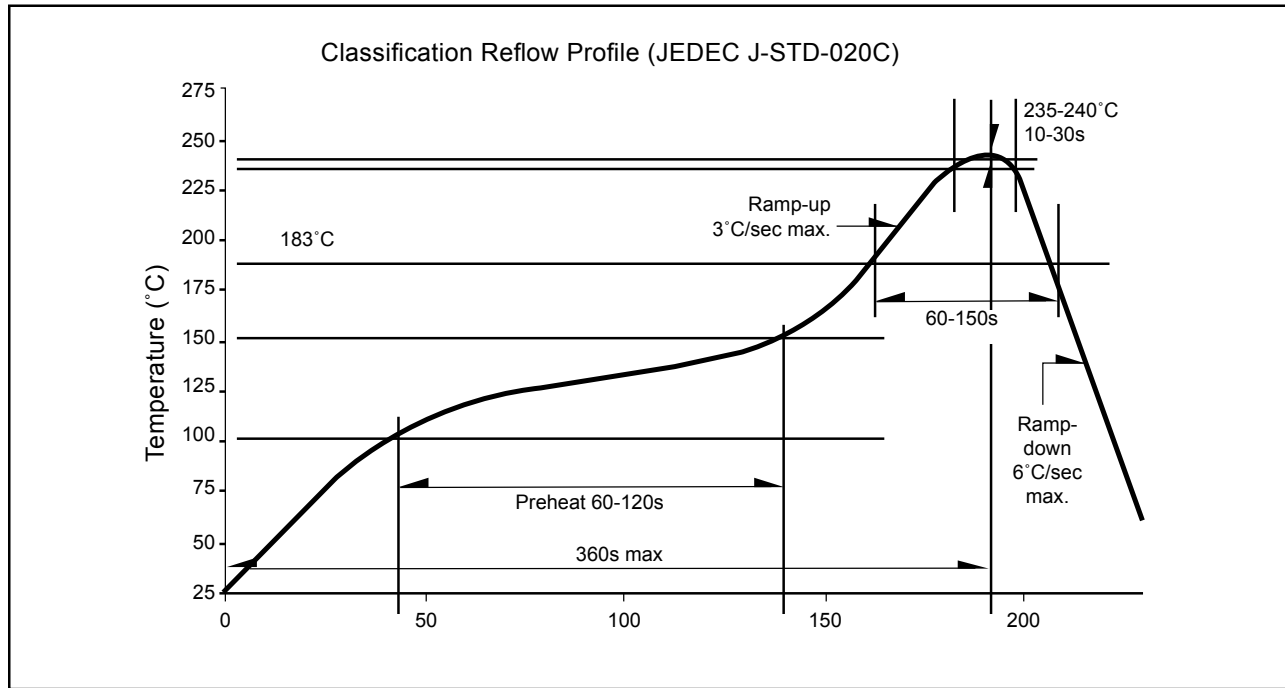

**Recommended Pb-free Soldering Profile**

