

IRF7335D1

- Co-Pack Dual N-channel HEXFET® Power MOSFET and Schottky Diode
- Ideal for Synchronous Buck DC-DC Converters Up to 11A Peak Output
- Low Conduction Losses
- Low Switching Losses
- Low Vf Schottky Rectifier

Dual FETKY™
Co-Packaged Dual MOSFET Plus Schottky Diode

Device Ratings (Typ. Values)

| | Q1 | Q2 and Schottky |
|--------------|---------|--------------------|
| $R_{DS(on)}$ | 13.4 mΩ | 9.6 mΩ |
| Q_G | 13 nC | 18 nC |
| Q_{sw} | 5.5 nC | 6.4 nC |
| V_{SD} | 1.0V | 0.43V |

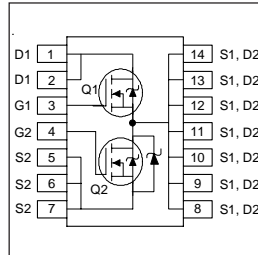
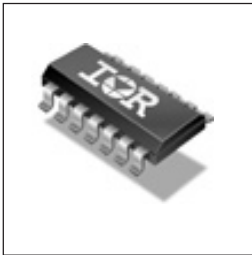

Description

The FETKY™ family of Co-Pack HEXFET® MOSFETs and Schottky diodes offers the designer an innovative, board space saving solution for switching regulator and power management applications. Advanced HEXFET® MOSFETs combined with low forward drop Schottky results in an extremely efficient device suitable for a wide variety of portable electronics applications.

The SO-14 has been modified through a customized leadframe for enhanced thermal characteristics and multiple die capability making it ideal in a variety of power applications. With these improvements multiple devices can be used in an application with dramatically reduced board space. Internal connections enable easier board layout design with reduced stray inductance.

Absolute Maximum Ratings

| | Parameter | Max. | Units |
|--------------------------------|--|------------------------|-------|
| V_{DS} | Drain-Source Voltage | 30 | V |
| $I_D @ T_A = 25^\circ\text{C}$ | Continuous Drain Current, $V_{GS} @ 10V$ ④ | 10 | A |
| $I_D @ T_A = 70^\circ\text{C}$ | Continuous Drain Current, $V_{GS} @ 10V$ ④ | 8.1 | |
| I_{DM} | Pulsed Drain Current ① | 81 | |
| $P_D @ T_A = 25^\circ\text{C}$ | Power Dissipation ③ | 2.0 | W |
| $P_D @ T_A = 70^\circ\text{C}$ | Power Dissipation ③ | 1.3 | |
| | Linear Derating Factor | 0.02 | W/°C |
| V_{GS} | Gate-to-Source Voltage | ± 12 | V |
| E_{AS} (6 sigma) | Single Pulse Avalanche Energy ⑤ | 50 | mJ |
| T_J | Operating Junction and | -55 to + 150 | °C |
| T_{STG} | Storage Temperature Range Soldering Temperature, for 10 seconds | 300 (1.6mm from case) | |

Thermal Resistance

| Symbol | Parameter | Typ. | Max. | Units |
|-----------------|------------------------|------|------|-------|
| $R_{\theta JL}$ | Junction-to-Drain Lead | | 20 | °C/W |
| $R_{\theta JA}$ | Junction-to-Ambient ③ | | 62.5 | |

Notes ① through ⑤ are on page 12

IRF7335D1

International
 Rectifier

| Electrical Characteristics | | Q1-Control FET | | | Q2-Synch FET & Schottky | | | Units | Conditions |
|------------------------------------|------------------------------|----------------|------|------|-------------------------|------|------|-------|---|
| | | Min | Typ | Max | Min | Typ | Max | | |
| Drain-to-Source Breakdown Voltage | BV_{DSS} | 30 | | | 30 | | | V | $V_{GS} = 0V, I_D = 250\mu A$ |
| Breakdown Voltage Tem. Coefficient | $\Delta BV_{DSS}/\Delta T_J$ | 0.025 | | | 0.033 | | | V | Reference to 25°C, $I_D = 1.0mA$ |
| Static Drain-Source on Resistance | $R_{DS(on)}$ | | 13.4 | 17.5 | | 9.6 | 12.8 | mΩ | $V_{GS} = 4.5V, I_D = 10A\textcircled{\text{C}}$ |
| Gate Threshold Voltage | $V_{GS(th)}$ | 1.0 | | | 1.1 | | | V | $V_{DS} = V_{GS}, I_D = 250\mu A$ |
| Drain-Source Leakage Current | I_{DSS} | | | 30 | | | 30 | μA | $V_{DS} = 24V, V_{GS} = 0$ |
| | | | | 0.3 | | | 10 | mA | $V_{DS} = 24V, V_{GS} = 0, T_J = 125^\circ C$ |
| Gate-Source Leakage Current | I_{GSS} | | | ±100 | | | ±100 | nA | $V_{GS} = \pm 12V$ |
| Forward Transconductance | g_{FS} | 21 | | | 28 | | | S | $V_{GS}=5V, I_D=8.0A, V_{DS}=15V$ |
| Total Gate Charge | Q_G | | 13 | 20 | | 18 | 27 | nC | $V_{GS}=4.5V, I_D=8.0A, V_{DS}=15V$ |
| Pre-Vth Gate-Source Charge | Q_{GS1} | | 3.2 | | | 5.8 | | | |
| Post-Vth Gate-Source Charge | Q_{GS2} | | 1.4 | | | 1.5 | | | |
| Gate to Drain Charge | Q_{GD} | | 4.1 | | | 4.9 | | | |
| Switch Chg($Q_{GS2} + Q_{GD}$) | Q_{sw} | | 5.5 | | | 6.4 | | | |
| Output Charge | Q_{OSS} | | 7.7 | | | 11 | | nC | $V_{DS} = 16V, V_{GS} = 0$ |
| Gate Resistance | R_G | | 4.3 | 10 | | 2.6 | 5.0 | Ω | |
| Turn-on Delay Time | $t_{d(on)}$ | | 6.8 | | | 8.8 | | ns | $V_{DD} = 16V, I_D = 8.0A$ $V_{GS} = 4.5V$ Clamped Inductive Load |
| Rise Time | t_r | | 5.9 | | | 3.3 | | | |
| Turn-off Delay Time | $t_{d(off)}$ | | 19 | | | 17 | | | |
| Fall Time | t_f | | 9.1 | | | 7.0 | | pF | $V_{DS} = 15V, V_{GS} = 0$ |
| Input Capacitance | C_{iss} | | 1500 | | | 2300 | | | |
| Output Capacitance | C_{oss} | | 310 | | | 450 | | | |
| Reverse Transfer Capacitance | C_{rss} | | 140 | | | 180 | | | |

Source-Drain Rating & Characteristics

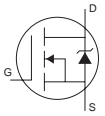
| Parameter | | Min | Typ | Max | Min | Typ | Max | Units | Conditions |
|--|----------|-----|-----|------|-----|------|------|-------|--|
| Continuous Source Current (Body Diode) | I_S | | | 10 | | | 10 | A | MOSFET symbol showing the intergral reverse p-n junction diode  |
| Pulse Source Current (Body Diode) | I_{SM} | | | 81 | | | 81 | | |
| Diode Forward Voltage | V_{SD} | | 1 | 1.25 | | 0.43 | 0.50 | V | $T_J = 25^\circ C, I_S = 1.0A, V_{GS} = 0V$ |
| Reverse Recovery Time | t_{rr} | | 28 | | | 31 | | ns | $T_J = 125^\circ C, I_F = 8.0A, V_R = 15V$ |
| Reverse Recovery Charge | Q_{rr} | | 24 | | | 26 | | nC | $di/dt = 100A/\mu s$ |
| Reverse Recovery Time | t_{rr} | | 29 | | | 31 | | ns | $T_J = 125^\circ C, I_F = 8.0A, V_R = 15V$ |
| Reverse Recovery Charge | Q_{rr} | | 26 | | | 26 | | nC | $di/dt = 100A/\mu s$ |

Typical Characteristics

Q1 - Control FET

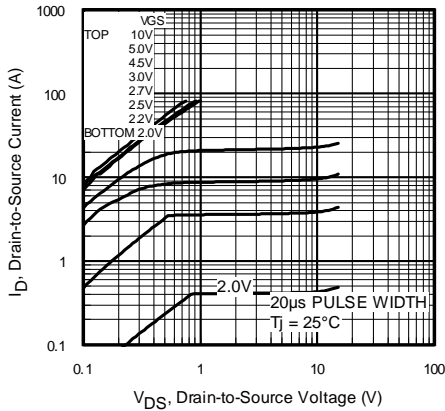

Fig 1. Typical Output Characteristics

Q2 - Synchronous FET & Schottky

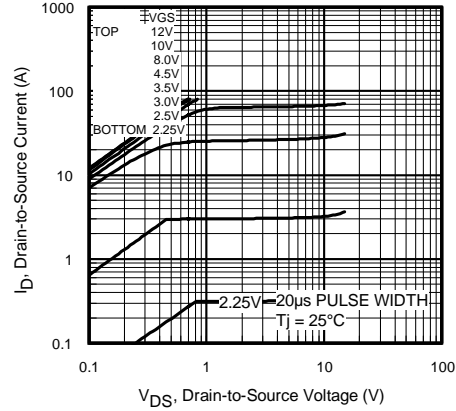

Fig 2. Typical Output Characteristics

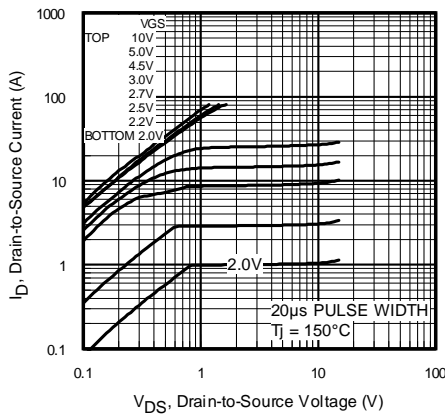

Fig 3. Typical Output Characteristics

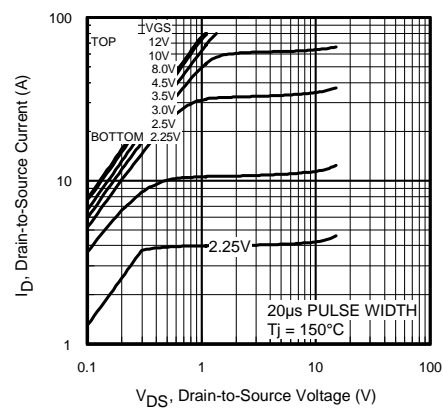

Fig 4. Typical Output Characteristics

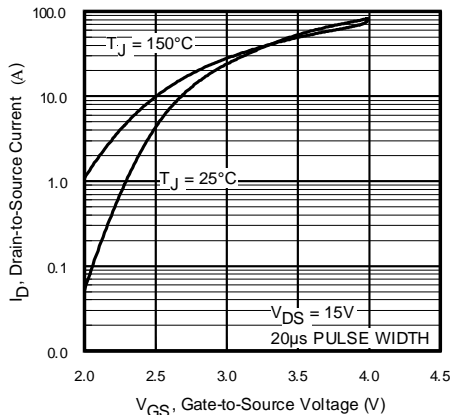

Fig 5. Typical Transfer Characteristics

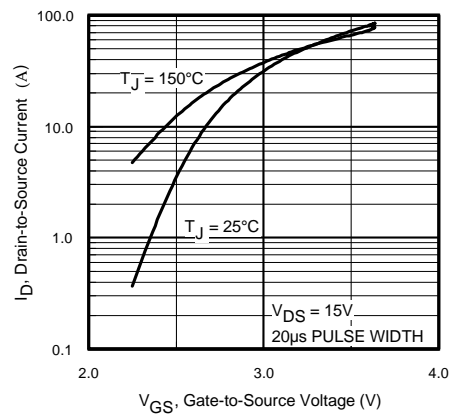

Fig 6. Typical Transfer Characteristics

Typical Characteristics

Q1 - Control FET

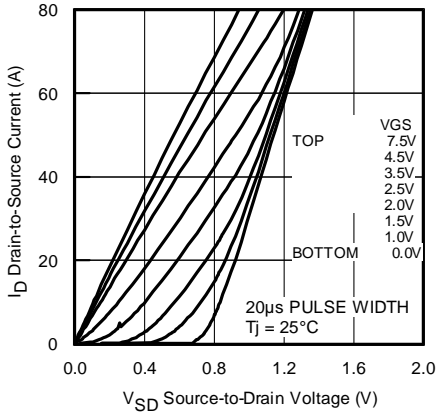

Fig. 7. Typical Reverse Output Characteristics

Q2 - Synchronous FET & Schottky

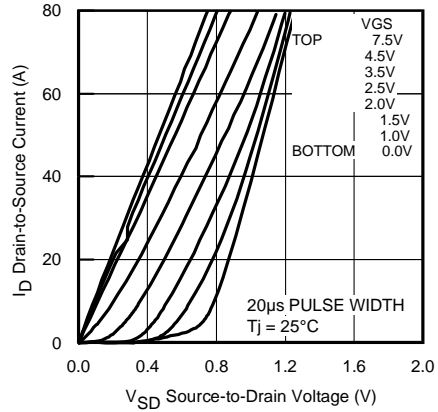

Fig. 8. Typical Reverse Output Characteristics

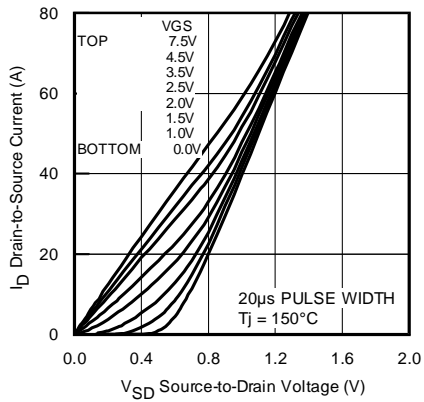

Fig. 9. Typical Reverse Output Characteristics

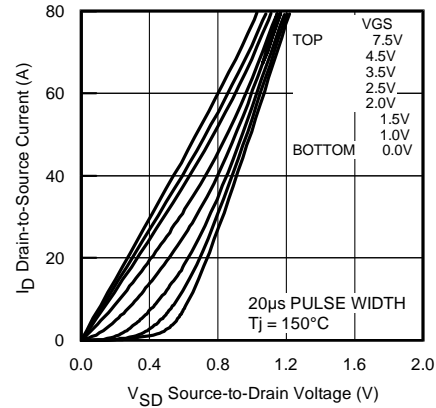

Fig. 10. Typical Reverse Output Characteristics

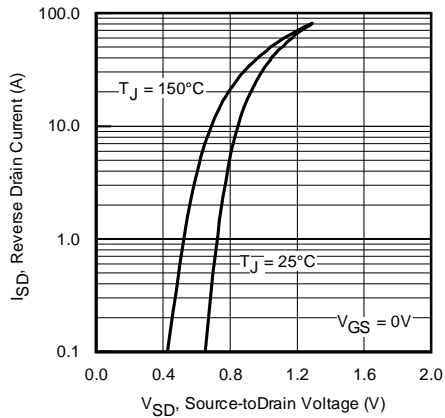

Fig 11. Typical Source-Drain Diode Forward Voltage

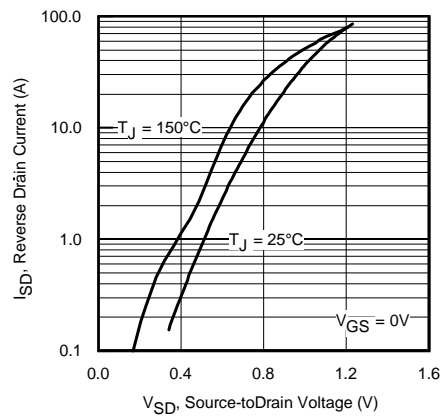

Fig 12. Typical Source-Drain Diode Forward Voltage

Typical Characteristics

Q1 - Control FET

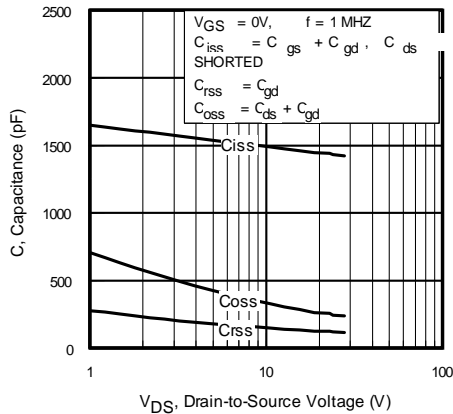

Fig 13. Typical Capacitance Vs. Drain-to-Source Voltage

Q2 - Synchronous FET & Schottky

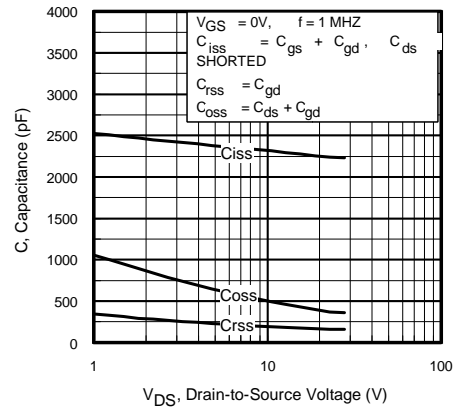

Fig 14. Typical Capacitance Vs. Drain-to-Source Voltage

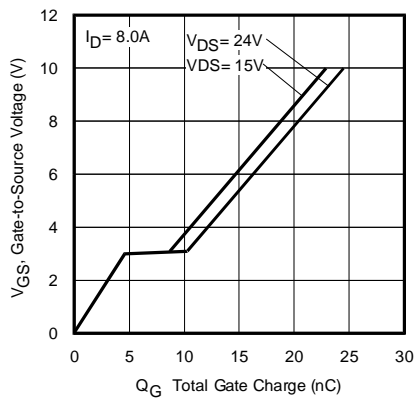

Fig 15. Gate-to-Source Voltage vs Typical Gate Charge

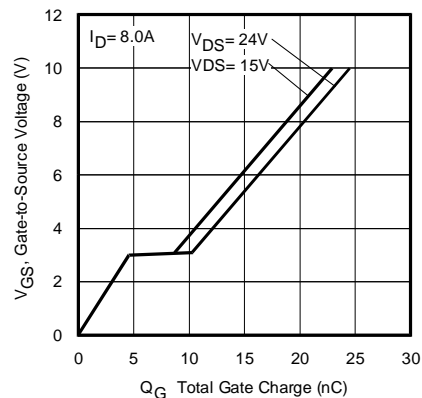

Fig 16. Gate-to-Source Voltage vs Typical Gate Charge

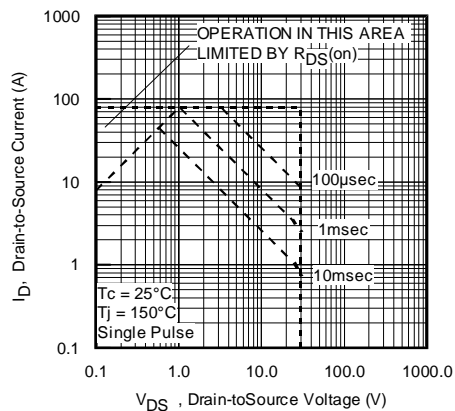

Fig 17. Maximum Safe Operating Area

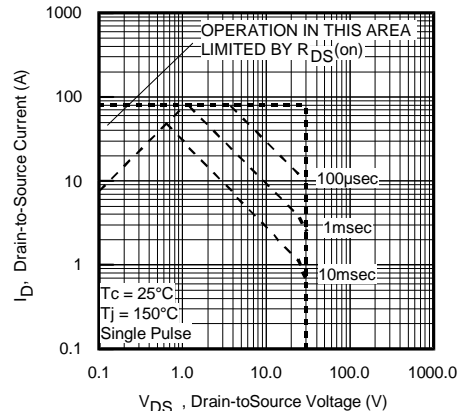

Fig 18. Maximum Safe Operating Area

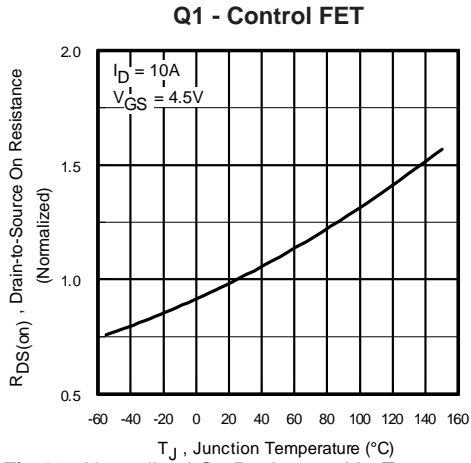

Fig 19. Normalized On-Resistance Vs. Temperature

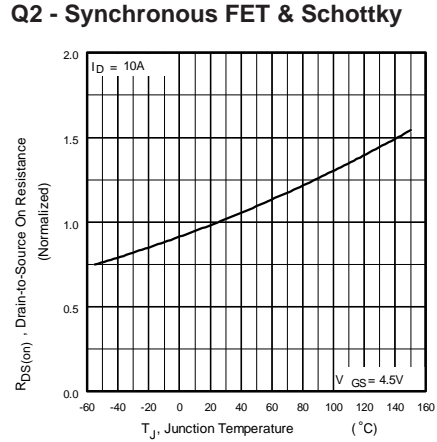

Fig 20. Normalized On-Resistance Vs. Temperature

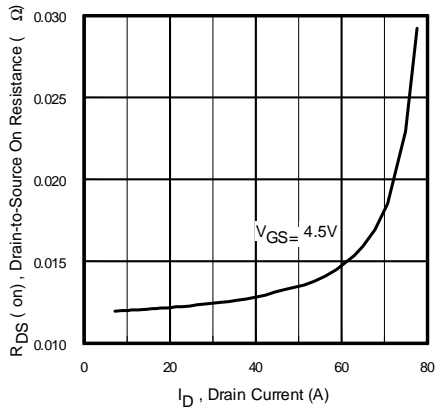

Fig 21. Typical On-Resistance Vs. Drain Current

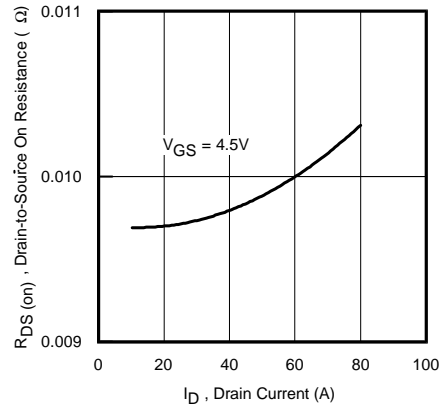

Fig 22. Typical On-Resistance Vs. Drain Current

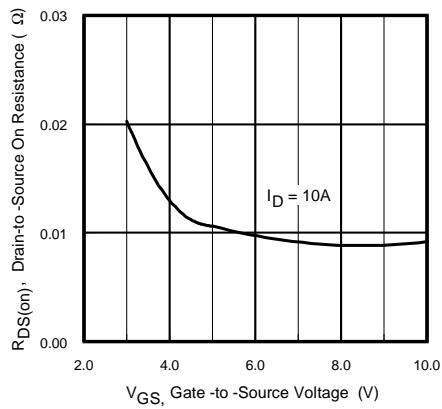

Fig 23. Typical On-Resistance Vs. Gate Voltage

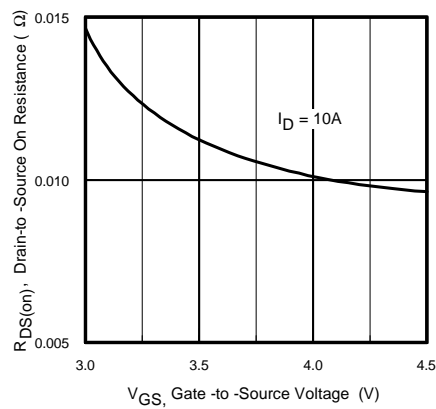

Fig 24. Typical On-Resistance Vs. Gate Voltage

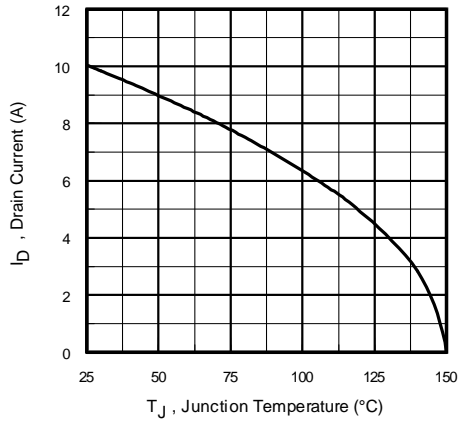

Fig 25. Maximum Drain Current Vs. Case Temperature

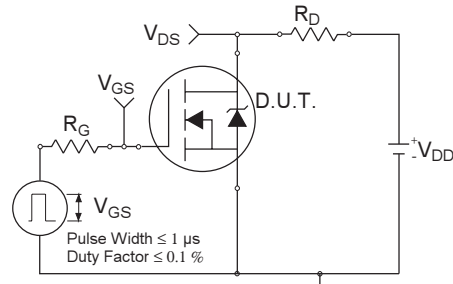

Fig 26a. Switching Time Test Circuit

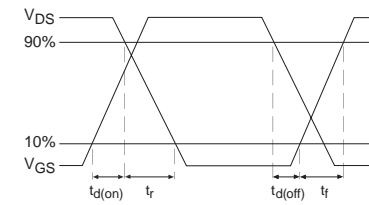

Fig 26b. Switching Time Waveforms

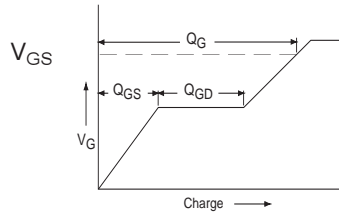
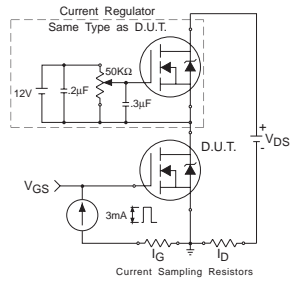

Fig 27a&b. Basic Gate Charge Test Circuit and Waveform

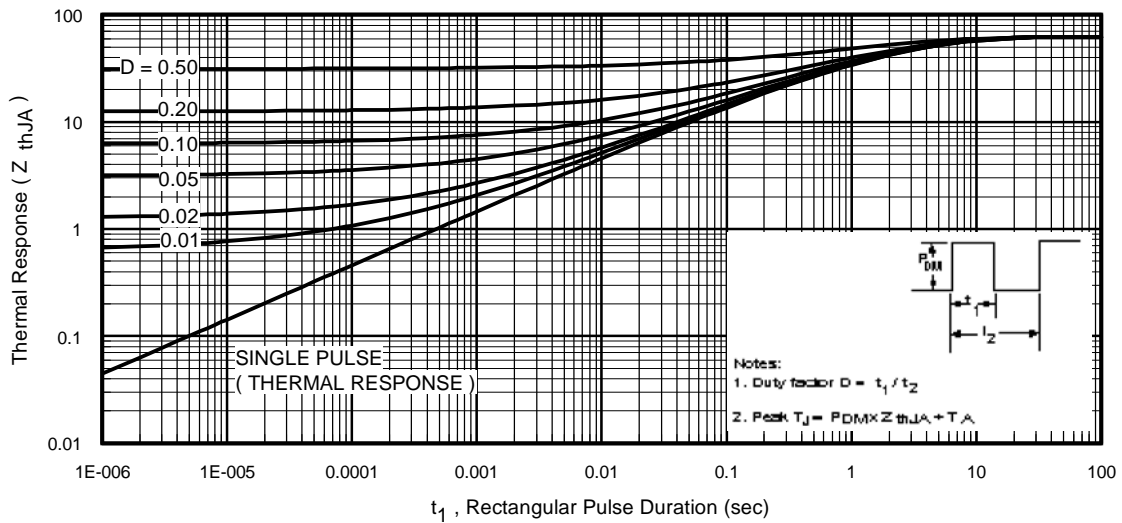

Fig. 28. Maximum Effective Transient Thermal Impedance, Junction-to-Ambient

Schottky Diode Characteristics

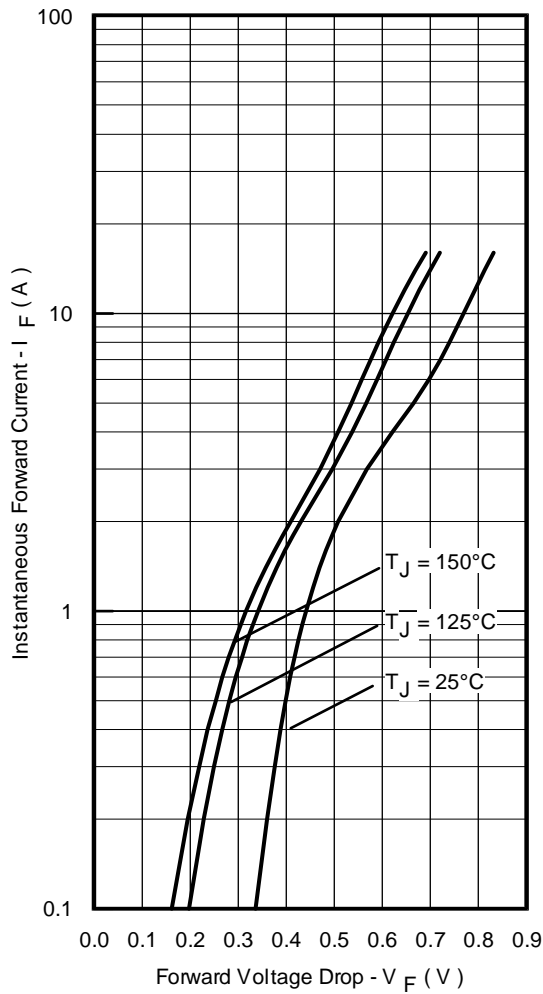

Fig. 29 - Maximum Forward Voltage Drop Characteristics

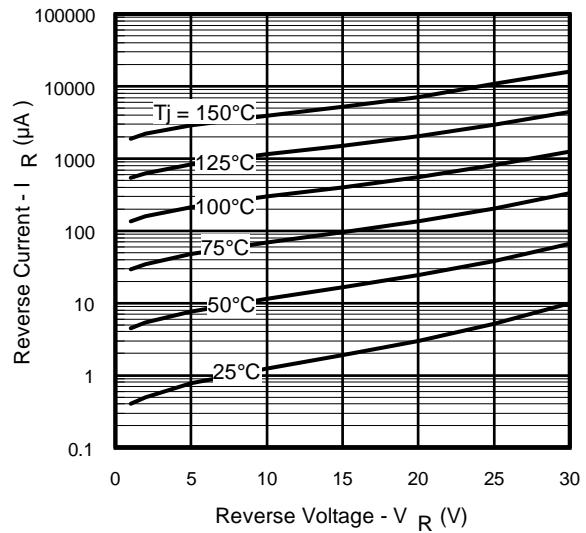

Fig. 30 - Typical Values of Reverse Current Vs. Reverse Voltage

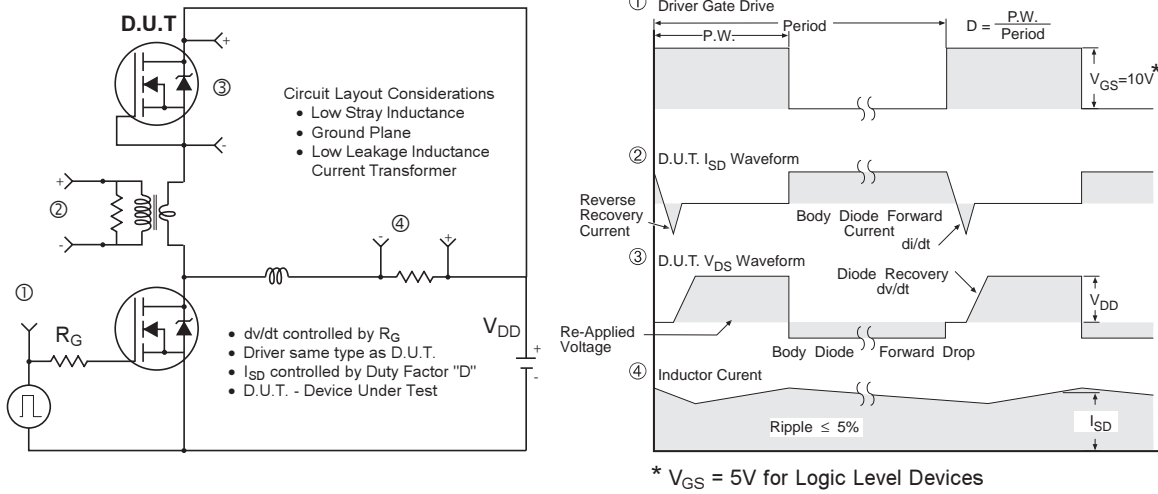

Fig. 31 Peak Diode Recovery dv/dt Test Circuit for N-Channel HEXFET® Power MOSFETs

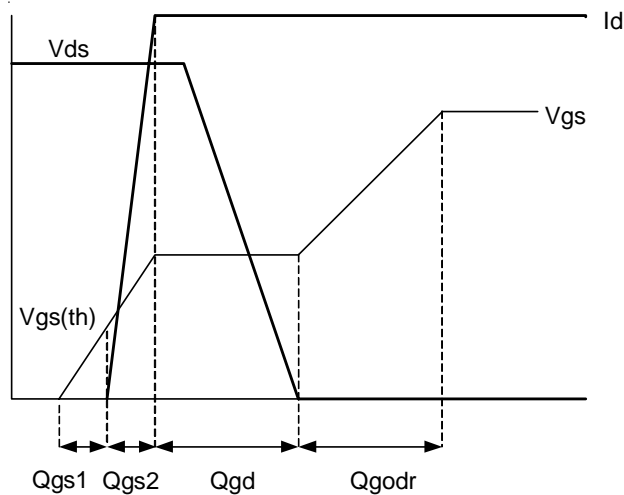

Fig. 32 Gate Charge Waveform

Power MOSFET Selection for Non-Isolated DC/DC Converters

Control FET

Special attention has been given to the power losses in the switching elements of the circuit - Q1 and Q2. Power losses in the high side switch Q1, also called the Control FET, are impacted by the $R_{ds(on)}$ of the MOSFET, but these conduction losses are only about one half of the total losses.

Power losses in the control switch Q1 are given by;

$$P_{loss} = P_{conduction} + P_{switching} + P_{drive} + P_{output}$$

This can be expanded and approximated by;

$$P_{loss} = (I_{rms}^2 \times R_{ds(on)}) + \left(I \times \frac{Q_{gd}}{i_g} \times V_{in} \times f \right) + \left(I \times \frac{Q_{gs2}}{i_g} \times V_{in} \times f \right) + (Q_g \times V_g \times f) + \left(\frac{Q_{oss}}{2} \times V_{in} \times f \right)$$

This simplified loss equation includes the terms Q_{gs2} and Q_{oss} which are new to Power MOSFET data sheets.

Q_{gs2} is a sub element of traditional gate-source charge that is included in all MOSFET data sheets. The importance of splitting this gate-source charge into two sub elements, Q_{gs1} and Q_{gs2} , can be seen from Fig 16.

Q_{gs2} indicates the charge that must be supplied by the gate driver between the time that the threshold voltage has been reached and the time the drain current rises to I_{dmax} at which time the drain voltage begins to change. Minimizing Q_{gs2} is a critical factor in reducing switching losses in Q1.

Q_{oss} is the charge that must be supplied to the output capacitance of the MOSFET during every switching cycle. Figure A shows how Q_{oss} is formed by the parallel combination of the voltage dependant (non-linear) capacitance's C_{ds} and C_{dg} when multiplied by the power supply input buss voltage.

Synchronous FET

The power loss equation for Q2 is approximated by;

$$P_{loss} = P_{conduction} + P_{drive} + P_{output}^*$$

$$P_{loss} = (I_{rms}^2 \times R_{ds(on)}) + (Q_g \times V_g \times f) + \left(\frac{Q_{oss}}{2} \times V_{in} \times f \right) + (Q_{rr} \times V_{in} \times f)$$

*dissipated primarily in Q1.

For the synchronous MOSFET Q2, $R_{ds(on)}$ is an important characteristic; however, once again the importance of gate charge must not be overlooked since it impacts three critical areas. Under light load the MOSFET must still be turned on and off by the control IC so the gate drive losses become much more significant. Secondly, the output charge Q_{oss} and reverse recovery charge Q_{rr} both generate losses that are transferred to Q1 and increase the dissipation in that device. Thirdly, gate charge will impact the MOSFETs' susceptibility to Cdv/dt turn on.

The drain of Q2 is connected to the switching node of the converter and therefore sees transitions between ground and V_{in} . As Q1 turns on and off there is a rate of change of drain voltage dV/dt which is capacitively coupled to the gate of Q2 and can induce a voltage spike on the gate that is sufficient to turn the MOSFET on, resulting in shoot-through current. The ratio of Q_{gd}/Q_{gs1} must be minimized to reduce the potential for Cdv/dt turn on.

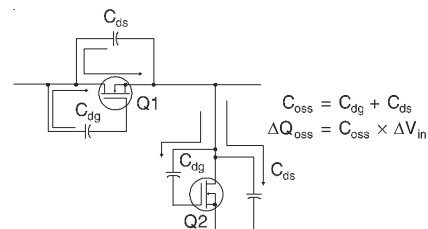
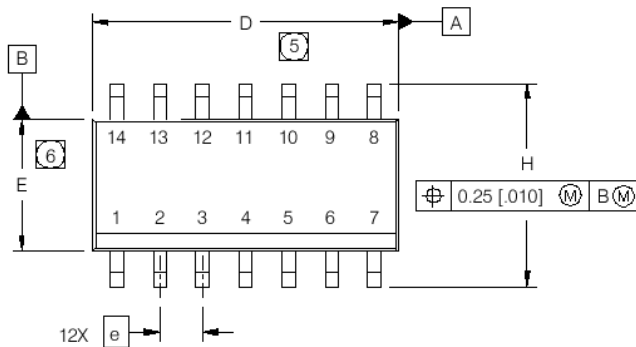
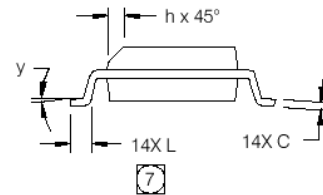
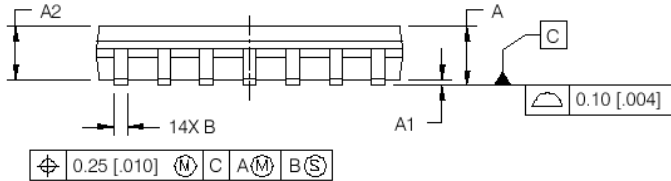

Figure A: Q_{oss} Characteristic

SO-14 Package Details



| DIM | INCHES | | MILLIMETERS | |
|-----|------------|-------|-------------|------|
| | MIN | MAX | MIN | MAX |
| A | .061 | .068 | 1.55 | 1.73 |
| A1 | .004 | .0098 | 0.127 | 0.25 |
| A2 | .055 | .061 | 1.40 | 1.55 |
| B | .0138 | .0192 | 0.35 | 0.49 |
| C | .0075 | .0098 | 0.19 | 0.25 |
| D | .337 | .344 | 8.58 | 8.74 |
| E | .150 | .157 | 3.81 | 3.99 |
| e | .050 BASIC | | 1.27 BASIC | |
| H | .230 | .244 | 5.84 | 6.20 |
| h | .010 | .016 | 0.25 | 0.41 |
| L | .016 | .035 | 0.41 | 0.89 |
| y | 0° | 8° | 0° | 8° |



SO-14 Part Marking

- DEVICE MARKING SHALL NOT EXHIBIT MISSING OR INCOMPLETE CHARACTERS WHICH IMPEDE LEGIBILITY.
- ALL MARKING SHALL BE ALIGNED TO THE CENTER OF THE DEVICE. OTHERWISE, THE MARKING SHALL, AS A MINIMUM, RETAIN ITS COMPLETE LEGIBILITY.
- DEVICES SHALL BE CAPABLE OF PASSING A MARKING PERMANENCY TEST (ACETONE FOR 5 MINUTES OR EQUIVALENT TEST). FAILURE CRITERIA: AFTER SUBJECTION TO THE TEST, SPECIFIED MARKING WHICH ARE MISSING IN WHOLE OR IN PART, FADED, SMEARED, BLURRED, OR DISLODGED TO THE EXTENT THAT THEY CANNOT READILY BE IDENTIFIED FROM A MINIMUM DISTANCE OF 15 cm (6") WITH NORMAL ROOM LIGHTING AND WITHOUT THE AID OF MAGNIFICATION OR WITH A VIEWER HAVING 0-3X MAGNIFICATION, SHALL CONSTITUTE FAILURE.
- TOP MARKING SHALL INCLUDE THE FOLLOWING:
 - IR LOGO
 - DATE CODE (YWW)
 Y = LAST DIGIT OF CALENDAR YEAR
 WW = WEEK OF MOLDING
 - XXXX = LOT CODE
 - PART NUMBER: 7335D1

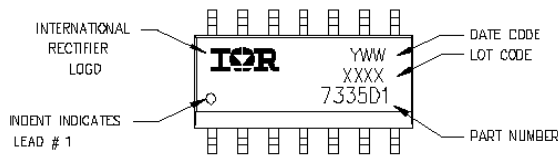

TOP MARKING

IRF7335D1

International
IR Rectifier

SO-14 Tape and Reel

NOTES, TAPE & REEL, LABELLING:

- | | |
|---|--|
| <p>1. TAPE AND REEL.</p> <p>1.1 REEL SIZE 13 INCH DIAMETER.</p> <p>1.2 EACH REEL CONTAINING 4,000 DEVICES.</p> <p>1.3 PEEL STRENGTH MUST CONFORM TO THE SPEC. NO. 71-9667.</p> <p>1.4 PART ORIENTATION SHALL BE AS SHOWN BELOW.</p> | <p>2. LABELLING (REEL AND SHIPPING BAG).</p> <p>2.1 CUST. PART NUMBER: IRF7335D1TR</p> <p>2.2 I.R. PART NUMBER: IRF7335D1TR</p> <p>2.3 QUANTITY:</p> <p>2.4 VENDOR CODE: IR</p> <p>2.5 LOT CODE:</p> <p>2.6 DATE CODE:</p> |
|---|--|

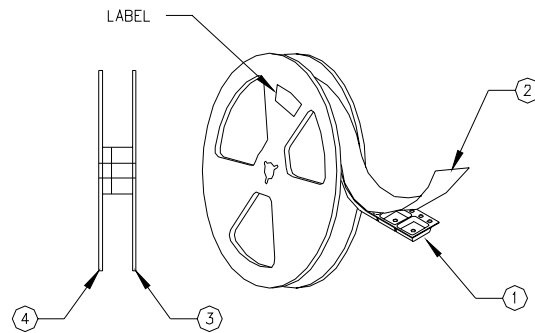
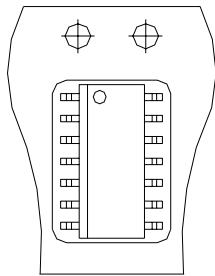

| | | | | |
|------|--|---------|---------------------------|-----|
| 4 | | 38-0027 | REEL, Ø 13", HALF, 4mm | 1 |
| 3 | | 38-0026 | REEL, Ø 13", HALF, 8mm | 1 |
| 2 | | 38-0023 | TAPE, COVER, 8mm CARRIER | A/R |
| 1 | | 38-0017 | TAPE, CARRIER, 8mm, SO-14 | A/R |
| ITEM | | IR No. | DESCRIPTION | QTY |

Notes:

- ① Repetitive rating; pulse width limited by max. junction temperature.
- ② Pulse width $\leq 300 \mu\text{s}$; duty cycle $\leq 2\%$.
- ③ When mounted on 1 inch square copper board.
- ④ Combined Q1, Q2 I_{RMS} @ Pwr V_{out} pins. Calculated continuous current based on max allowable junction temperature; switching or other losses will decrease RMS current capability
- ⑤ Q1 and Q2 is tested 100% in production to 50mJ to stress and eliminate potentially defective parts. This is not a design for use value.

Data and specifications subject to change without notice.
This product has been designed and qualified for the consumer market.
Qualification Standards can be found on IR's Web site.

International
IR Rectifier

IR WORLD HEADQUARTERS: 233 Kansas St., El Segundo, California 90245, USA Tel: (310) 252-7105
TAC Fax: (310) 252-7903

Visit us at www.irf.com for sales contact information.9/02

www.irf.com