

FAIRCHILD

A Schlumberger Company

IRF420-423/IRF820-823 T-39-11
MTP2N45/2N50
N-Channel Power MOSFETs,
3.0 A, 450 V/500 V

Power And Discrete Division

Description

These devices are n-channel, enhancement mode, power MOSFETs designed especially for high speed applications, such as switching power supplies, converters, AC and DC motor controls, relay and solenoid drivers and other pulse circuits.

- Low $R_{DS(on)}$
- V_{GS} Rated at ± 20 V
- Silicon Gate for Fast Switching Speeds
- I_{DSS} , $V_{DS(on)}$, Specified at Elevated Temperature
- Rugged
- Low Drive Requirements
- Ease of Paralleling

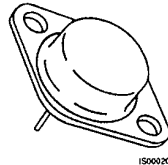
TO-204AA

IRF420
IRF421
IRF422
IRF423

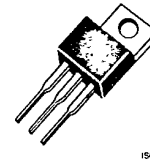
TO-220AB

IRF820
IRF821
IRF822
IRF823
MTP2N45
MTP2N50

Product Summary

Part Number	V_{DSS}	$R_{DS(on)}$	I_D at $T_C = 25^\circ C$	I_D at $T_C = 100^\circ C$	Case Style
IRF420	500 V	3.0 Ω	2.5 A	1.5 A	TO-204AA
IRF421	450 V	3.0 Ω	2.5 A	1.5 A	
IRF422	500 V	4.0 Ω	2.0 A	1.0 A	
IRF423	450 V	4.0 Ω	2.0 A	1.0 A	
IRF820	500 V	3.0 Ω	2.5 A	1.5 A	TO-220AB
IRF821	450 V	3.0 Ω	2.5 A	1.5 A	
IRF822	500 V	4.0 Ω	2.0 A	1.0 A	
IRF823	450 V	4.0 Ω	2.0 A	1.0 A	
MTP2N45	450 V	4.0 Ω	3.0 A	2.0 A	
MTP2N50	500 V	4.0 Ω	3.0 A	2.0 A	

Notes

For information concerning connection diagram and package outline, refer to Section 7.

IRF420-423/IRF820-823
MTP2N45/2N50

T-39-11

Maximum Ratings

Symbol	Characteristic	Rating IRF420/422 IRF820/822 MTP2N50	Rating IRF421/423 IRF821/823 MTP2N45	Unit
V _{DSS}	Drain to Source Voltage ¹	500	450	V
V _{DGR}	Drain to Gate Voltage ¹ R _{GS} = 20 kΩ	500	450	V
V _{GS}	Gate to Source Voltage	± 20	± 20	V
T _J , T _{stg}	Operating Junction and Storage Temperatures	-55 to +150	-55 to +150	°C
T _L	Maximum Lead Temperature for Soldering Purposes, 1/8" From Case for 5 s	275	275	°C

Maximum Thermal Characteristics

		IRF420-423/ IRF820-823	MTP2N45/2N50	
R _{θJC}	Thermal Resistance, Junction to Case	3.12	1.67	°C/W
R _{θJA}	Thermal Resistance, Junction to Ambient	30/80	80	°C/W
P _D	Total Power Dissipation at T _C = 25°C	40	75	W
I _{DM}	Pulsed Drain Current ²	10	10	A

Electrical Characteristics (T_C = 25°C unless otherwise noted)

Symbol	Characteristic	Min	Max	Unit	Test Conditions
Off Characteristics					
V _{(BR)DSS}	Drain Source Breakdown Voltage ¹ IRF420/422/820/822/ MTP2N50	500		V	V _{GS} = 0 V, I _D = 250 μA
		450			
I _{DSS}	Zero Gate Voltage Drain Current		250	μA	V _{DS} = Rated V _{DSS} , V _{GS} = 0 V
			1000	μA	V _{DS} = 0.8 x Rated V _{DSS} , V _{GS} = 0 V, T _C = 125°C
I _{GSS}	Gate-Body Leakage Current IRF420-423		± 100	nA	V _{GS} = ± 20 V, V _{DS} = 0 V
			± 500		
	IRF820-823/MTP2N45/50				

IRF420-423/IRF820-823
MTP2N45/2N50

T-39-11

Electrical Characteristics (Cont.) ($T_C = 25^\circ\text{C}$ unless otherwise noted)

Symbol	Characteristic	Min	Max	Unit	Test Conditions
On Characteristics					
$V_{GS(th)}$	Gate Threshold Voltage			V	$I_D = 250 \mu\text{A}$, $V_{DS} = V_{GS}$ $I_D = 1.0 \text{ mA}$, $V_{DS} = V_{GS}$
	IRF420-423/IRF820-823	2.0	4.0		
	MTP2N45/MTP2N50	2.0	4.5		
$R_{DS(on)}$	Static Drain-Source On-Resistance ²			Ω	$V_{GS} = 10 \text{ V}$, $I_D = 1.0 \text{ A}$
	IRF420/421/820/821		3.0		
	IRF422/423/822/823		4.0		
	MTP2N45/50		4.0		
$V_{DS(on)}$	Drain-Source On-Voltage ²			V	$V_{GS} = 10 \text{ V}$; $I_D = 2.0 \text{ A}$ $V_{GS} = 10 \text{ V}$; $I_D = 1.0 \text{ A}$ $T_C = 100^\circ\text{C}$
	MTP2N45/50		10		
			8		
g_{fs}	Forward Transconductance	1.0		S (Ω)	$V_{DS} = 10 \text{ V}$, $I_D = 1.0 \text{ A}$

Dynamic Characteristics

C_{iss}	Input Capacitance		400	pF	$V_{DS} = 25 \text{ V}$, $V_{GS} = 0 \text{ V}$ $f = 1.0 \text{ MHz}$
C_{oss}	Output Capacitance		100	pF	
C_{rss}	Reverse Transfer Capacitance		40	pF	

Switching Characteristics ($T_C = 25^\circ\text{C}$, Figures 1, 2)³

$t_{d(on)}$	Turn-On Delay Time		40	ns	$V_{DD} = 250 \text{ V}$, $I_D = 1.0 \text{ A}$ $V_{GS} = 10 \text{ V}$, $R_{GEN} = 50 \Omega$ $R_{GS} = 50 \Omega$
t_r	Rise Time		50	ns	
$t_{d(off)}$	Turn-Off Delay Time		60	ns	
t_f	Fall Time		60	ns	
Q_g	Total Gate Charge		15	nC	$V_{GS} = 10 \text{ V}$, $I_D = 3.0 \text{ A}$ $V_{DD} = 200 \text{ V}$

Symbol	Characteristic	Typ	Max	Unit	Test Conditions
Source-Drain Diode Characteristics					
V_{SD}	Diode Forward Voltage		1.4	V	$I_S = 2.5 \text{ A}$; $V_{GS} = 0 \text{ V}$
			1.3	V	$I_S = 2.0 \text{ A}$; $V_{GS} = 0 \text{ V}$
t_{rr}	Reverse Recovery Time	600		ns	$I_S = 2.5 \text{ A}$; $dI_S/dt = 100 \text{ A}/\mu\text{S}$

Notes

- $T_J = +25^\circ\text{C}$ to $+150^\circ\text{C}$
- Pulse width limited by T_J
- Switching time measurements performed on LEM TR-58 test equipment.

IRF420-423/IRF820-823

MTP2N45/2N50

T-39-11

Typical Electrical Characteristics

Figure 1 Switching Test Circuit

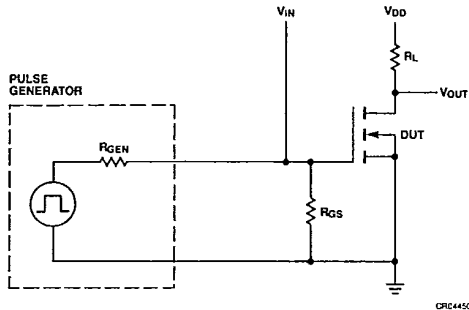

CRC4450F

Figure 2 Switching Waveforms

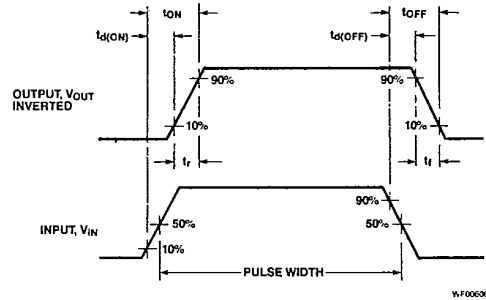

WF00000F

Typical Performance Curves

Figure 3 Output Characteristics

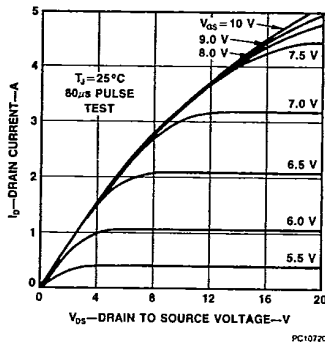

PC10720F

Figure 4 Static Drain to Source Resistance vs Drain Current

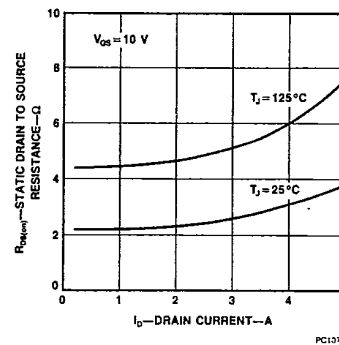

PC13730F

Figure 5 Transfer Characteristics

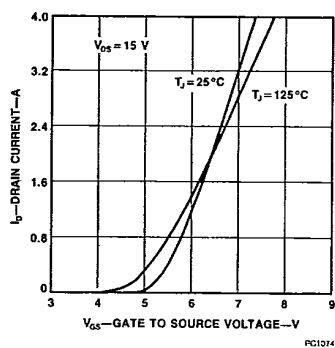

PC10740F

Figure 6 Temperature Variation of Gate to Source Threshold Voltage

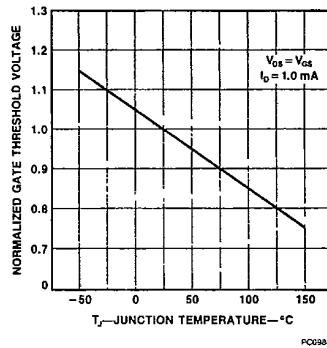

PC03841F

IRF420-423/IRF820-823
MTP2N45/2N50

T-39-11

Typical Performance Curves (Cont.)

Figure 7 Capacitance vs Drain to Source Voltage

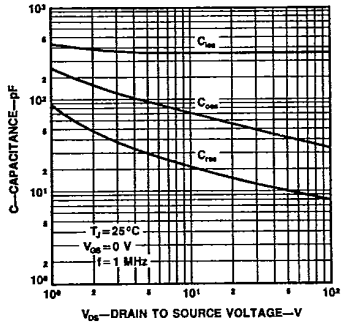

Figure 9 Forward Biased Safe Operating Area for IRF420-423 and IRF820-823

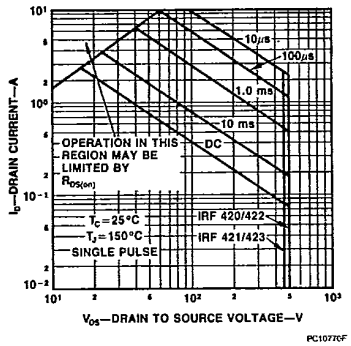

Figure 11 Forward Biased Safe Operating Area for MTP2N45/2N50

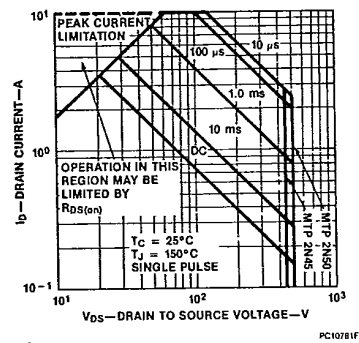

Figure 8 Gate to Source Voltage vs Total Gate Charge

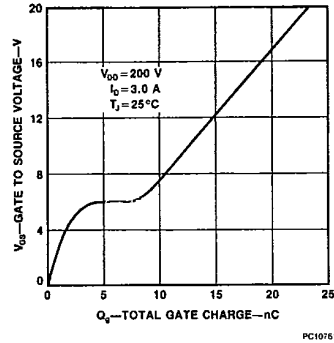

Figure 10 Transient Thermal Resistance vs Time for IRF420-423 and IRF820-823

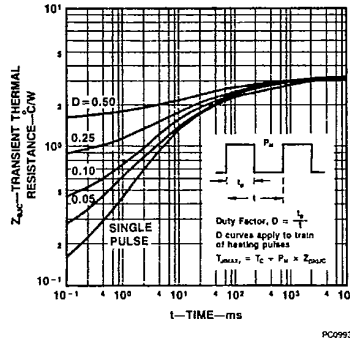

Figure 12 Transient Thermal Resistance vs Time for MTP2N45/2N50

