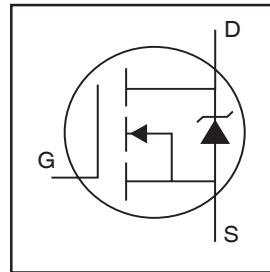


# IRF3710S

# IRF3710L

HEXFET® Power MOSFET

- Advanced Process Technology
- Ultra Low On-Resistance
- Dynamic dv/dt Rating
- 175°C Operating Temperature
- Fast Switching
- Fully Avalanche Rated

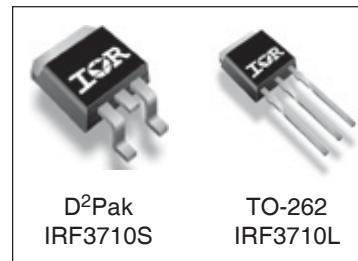


$V_{DSS} = 100V$
$R_{DS(on)} = 23m\Omega$
$I_D = 57A$

## Description

Advanced HEXFET® Power MOSFETs from International Rectifier utilize advanced processing techniques to achieve extremely low on-resistance per silicon area. This benefit, combined with the fast switching speed and ruggedized device design that HEXFET power MOSFETs are well known for, provides the designer with an extremely efficient and reliable device for use in a wide variety of applications.

The D<sup>2</sup>Pak is a surface mount power package capable of accommodating die sizes up to HEX-4. It provides the highest power capability and the lowest possible on-resistance in any existing surface mount package. The D<sup>2</sup>Pak is suitable for high current applications because of its low internal connection resistance and can dissipate up to 2.0W in a typical surface mount application. The through-hole version (IRF3710L) is available for low-profile applications.



D<sup>2</sup>Pak  
IRF3710S

TO-262  
IRF3710L

## Absolute Maximum Ratings

	Parameter	Max.	Units
$I_D @ T_C = 25^\circ C$	Continuous Drain Current, $V_{GS} @ 10V$ ⑦	57	A
$I_D @ T_C = 100^\circ C$	Continuous Drain Current, $V_{GS} @ 10V$ ⑦	40	
$I_{DM}$	Pulsed Drain Current ① ⑦	180	
$P_D @ T_C = 25^\circ C$	Power Dissipation	200	W
	Linear Derating Factor	1.3	W/°C
$V_{GS}$	Gate-to-Source Voltage	$\pm 20$	V
$I_{AR}$	Avalanche Current ①	28	A
$E_{AR}$	Repetitive Avalanche Energy ①	20	mJ
dv/dt	Peak Diode Recovery dv/dt ③ ⑦	5.8	V/ns
$T_J$	Operating Junction and	-55 to + 175	°C
$T_{STG}$	Storage Temperature Range		
	Soldering Temperature, for 10 seconds		

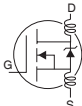
## Thermal Resistance

	Parameter	Typ.	Max.	Units
$R_{\theta JC}$	Junction-to-Case	—	0.75	°C/W
$R_{\theta JA}$	Junction-to-Ambient (PCB Mounted, steady-state)**	—	40	

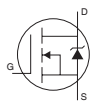
# IRF3710S/IRF3710L

International  
IR Rectifier

## Electrical Characteristics @ $T_J = 25^\circ\text{C}$ (unless otherwise specified)

	Parameter	Min.	Typ.	Max.	Units	Conditions
$V_{(BR)DSS}$	Drain-to-Source Breakdown Voltage	100	—	—	V	$V_{GS} = 0V, I_D = 250\mu A$
$\Delta V_{(BR)DSS}/\Delta T_J$	Breakdown Voltage Temp. Coefficient	—	0.13	—	V/°C	Reference to $25^\circ\text{C}$ , $I_D = 1\text{mA}$ ⑦
$R_{DS(on)}$	Static Drain-to-Source On-Resistance	—	—	23	mΩ	$V_{GS} = 10V, I_D = 28A$ ④
$V_{GS(th)}$	Gate Threshold Voltage	2.0	—	4.0	V	$V_{DS} = V_{GS}, I_D = 250\mu A$
$g_{fs}$	Forward Transconductance	32	—	—	S	$V_{DS} = 25V, I_D = 28A$ ④⑦
$I_{DSS}$	Drain-to-Source Leakage Current	—	—	25	μA	$V_{DS} = 100V, V_{GS} = 0V$
		—	—	250		$V_{DS} = 80V, V_{GS} = 0V, T_J = 150^\circ\text{C}$
$I_{GSS}$	Gate-to-Source Forward Leakage	—	—	100	nA	$V_{GS} = 20V$
	Gate-to-Source Reverse Leakage	—	—	-100		$V_{GS} = -20V$
$Q_g$	Total Gate Charge	—	—	130	nC	$I_D = 28A$
$Q_{gs}$	Gate-to-Source Charge	—	—	26		$V_{DS} = 80V$
$Q_{gd}$	Gate-to-Drain ("Miller") Charge	—	—	43		$V_{GS} = 10V$ , See Fig. 6 and 13⑦
$t_{d(on)}$	Turn-On Delay Time	—	12	—	ns	$V_{DD} = 50V$
$t_r$	Rise Time	—	58	—		$I_D = 28A$
$t_{d(off)}$	Turn-Off Delay Time	—	45	—		$R_G = 2.5\Omega$
$t_f$	Fall Time	—	47	—		$V_{GS} = 10V$ , See Fig. 10 ④⑦
$L_D$	Internal Drain Inductance	—	4.5	—	nH	Between lead, 6mm (0.25in.) from package and center of die contact
$L_S$	Internal Source Inductance	—	7.5	—		
$C_{iss}$	Input Capacitance	—	3130	—	pF	$V_{GS} = 0V$
$C_{oss}$	Output Capacitance	—	410	—		$V_{DS} = 25V$
$C_{rss}$	Reverse Transfer Capacitance	—	72	—		$f = 1.0\text{MHz}$ , See Fig. 5⑦
$E_{AS}$	Single Pulse Avalanche Energy②⑦	—	1060③	280⑥		mJ

## Source-Drain Ratings and Characteristics

	Parameter	Min.	Typ.	Max.	Units	Conditions
$I_S$	Continuous Source Current (Body Diode)	—	—	57	A	MOSFET symbol showing the integral reverse p-n junction diode. 
$I_{SM}$	Pulsed Source Current (Body Diode)①	—	—	230		
$V_{SD}$	Diode Forward Voltage	—	—	1.2	V	$T_J = 25^\circ\text{C}, I_S = 28A, V_{GS} = 0V$ ④
$t_{rr}$	Reverse Recovery Time	—	140	220	ns	$T_J = 25^\circ\text{C}, I_F = 28A$
$Q_{rr}$	Reverse Recovery Charge	—	670	1010	nC	$di/dt = 100A/\mu s$ ④
$t_{on}$	Forward Turn-On Time	Intrinsic turn-on time is negligible (turn-on is dominated by $L_S+L_D$ )				

### Notes:

- ① Repetitive rating; pulse width limited by max. junction temperature. (See fig. 11).
- ② Starting  $T_J = 25^\circ\text{C}$ ,  $L = 0.70\text{mH}$ ,  $R_G = 25\Omega$ ,  $I_{AS} = 28A$ ,  $V_{GS} = 10V$ . (See Figure 12).
- ③  $I_{SD} \leq 28A$ ,  $di/dt \leq 380A/\mu s$ ,  $V_{DD} \leq V_{(BR)DSS}$ ,  $T_J \leq 175^\circ\text{C}$ .
- ④ Pulse width  $\leq 400\mu s$ ; duty cycle  $\leq 2\%$ .

⑤ This is a typical value at device destruction and represents operation outside rated limits.

⑥ This is a calculated value limited to  $T_J = 175^\circ\text{C}$ .

⑦ Uses IRF3710 data and test conditions.

\*\*When mounted on 1" square PCB (FR-4 or G-10 Material). For recommended footprint and soldering techniques refer to application note #AN-994.

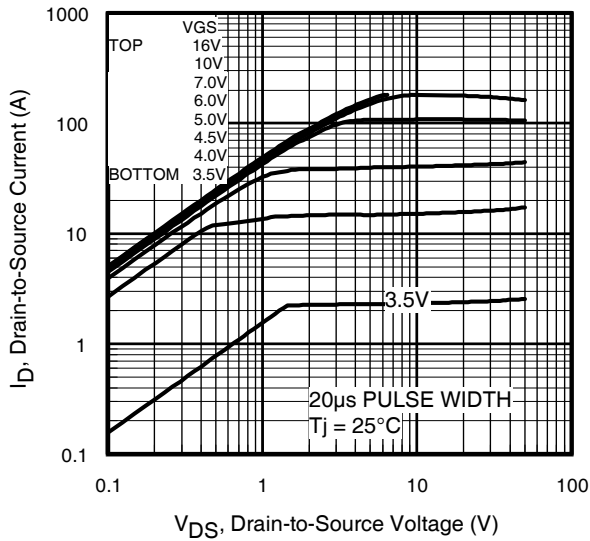


Fig 1. Typical Output Characteristics

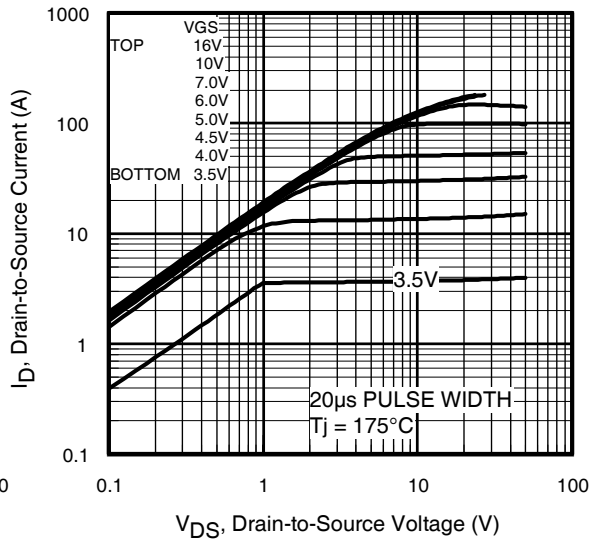


Fig 2. Typical Output Characteristics

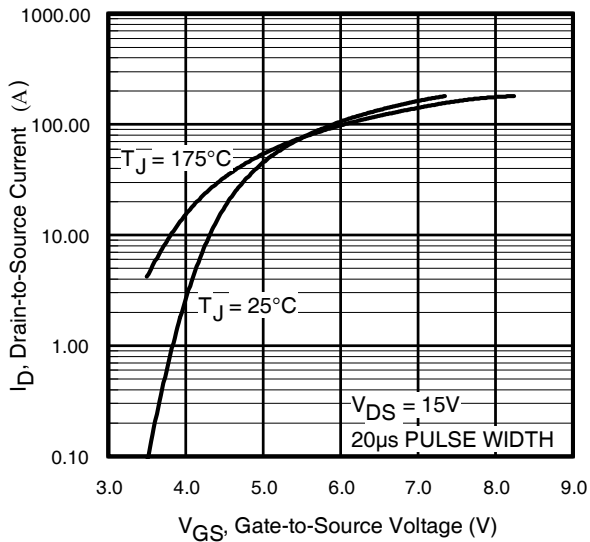


Fig 3. Typical Transfer Characteristics

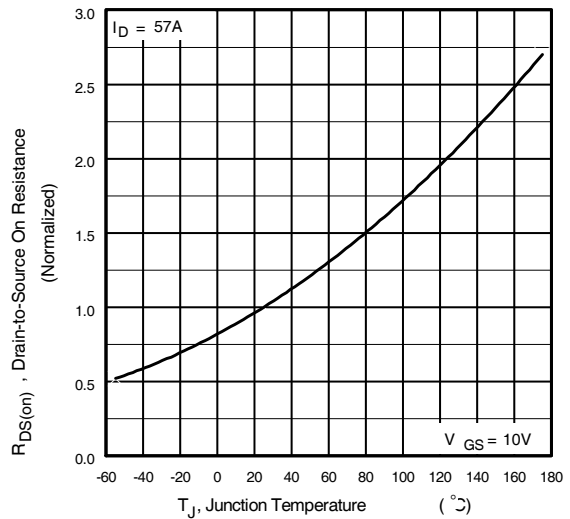
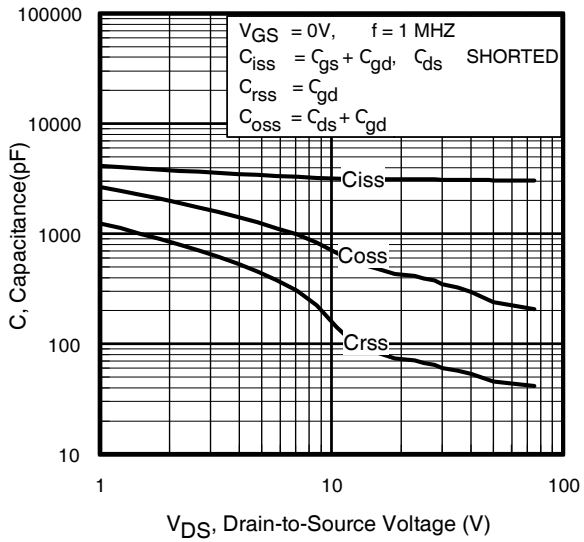


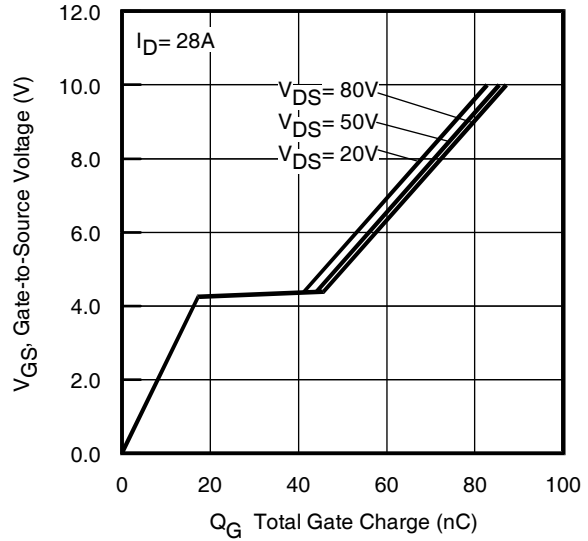
Fig 4. Normalized On-Resistance Vs. Temperature

# IRF3710S/IRF3710L

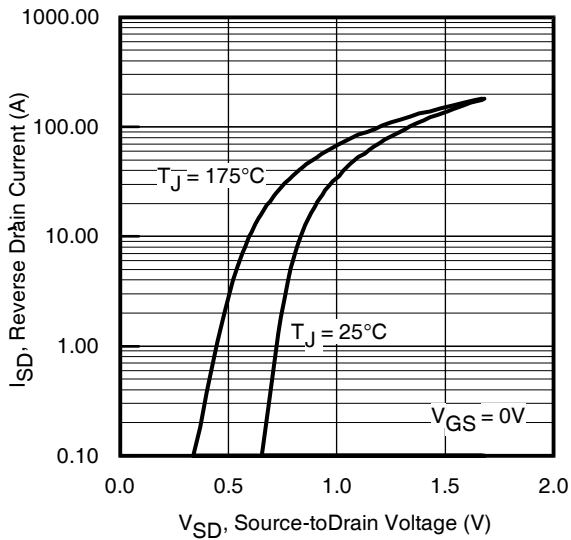
International  
**IR** Rectifier



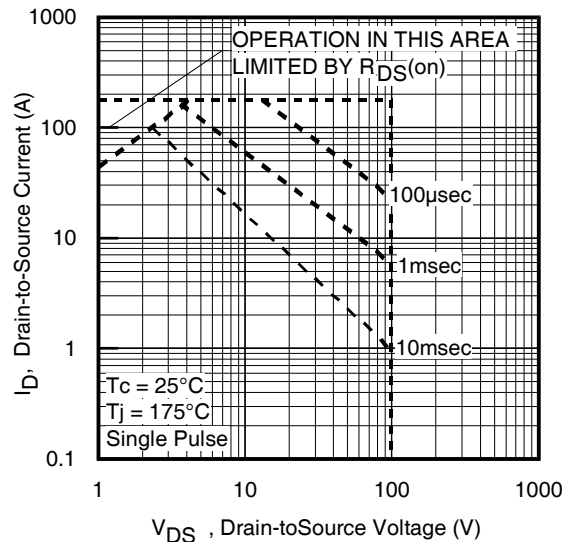
**Fig 5.** Typical Capacitance Vs. Drain-to-Source Voltage



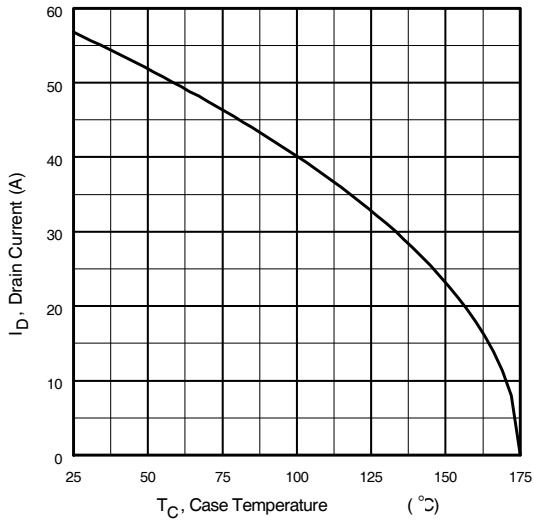
**Fig 6.** Typical Gate Charge Vs. Gate-to-Source Voltage



**Fig 7.** Typical Source-Drain Diode Forward Voltage



**Fig 8.** Maximum Safe Operating Area



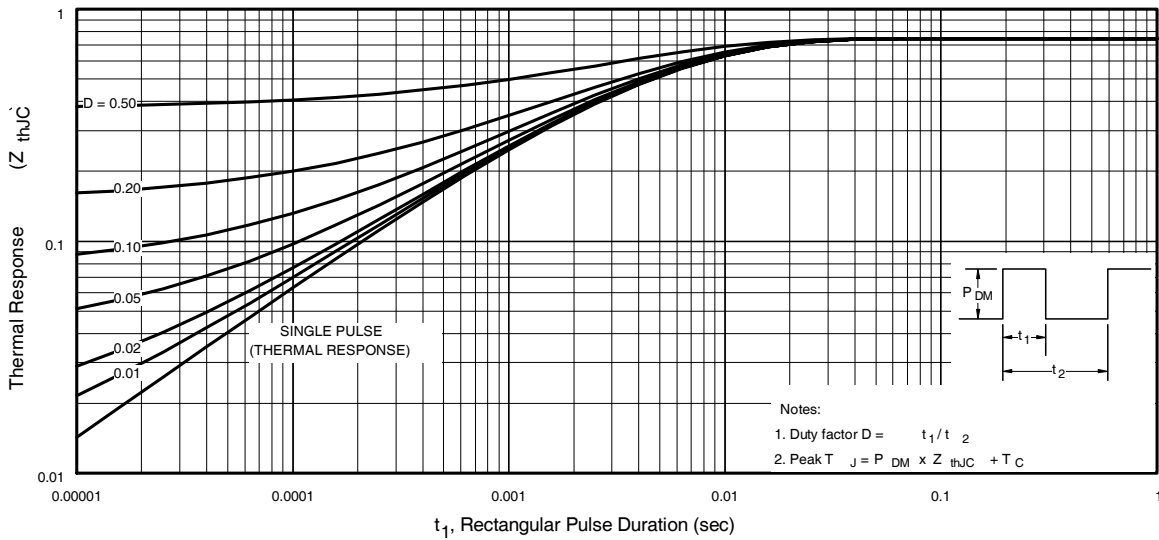
**Fig 9.** Maximum Drain Current Vs. Case Temperature



**Fig 10a.** Switching Time Test Circuit

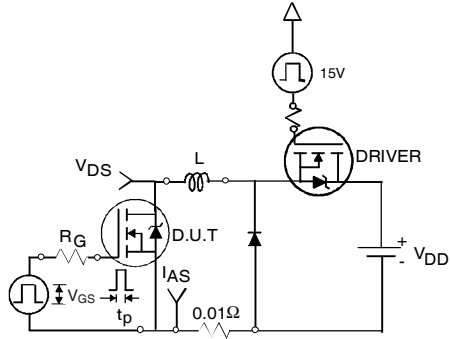


**Fig 10b.** Switching Time Waveforms



**Fig 11.** Maximum Effective Transient Thermal Impedance, Junction-to-Case

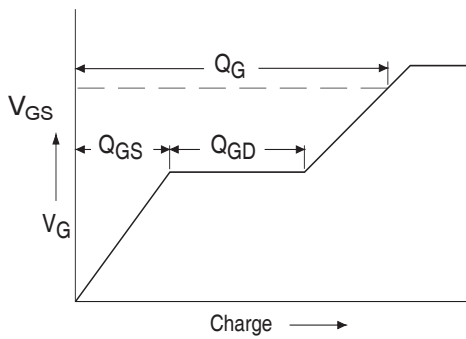
# IRF3710S/IRF3710L



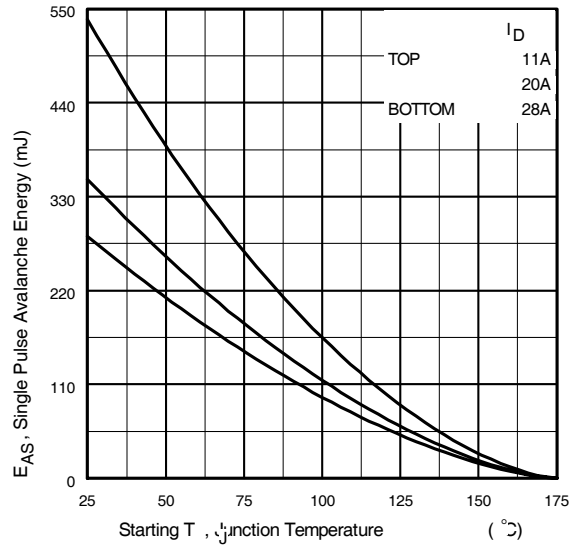
**Fig 12a.** Unclamped Inductive Test Circuit



**Fig 12b.** Unclamped Inductive Waveforms



**Fig 13a.** Basic Gate Charge Waveform



**Fig 12c.** Maximum Avalanche Energy Vs. Drain Current



**Fig 13b.** Gate Charge Test Circuit

## Peak Diode Recovery dv/dt Test Circuit



\* Reverse Polarity of D.U.T for P-Channel



\*\*\*  $V_{GS} = 5.0V$  for Logic Level and 3V Drive Devices

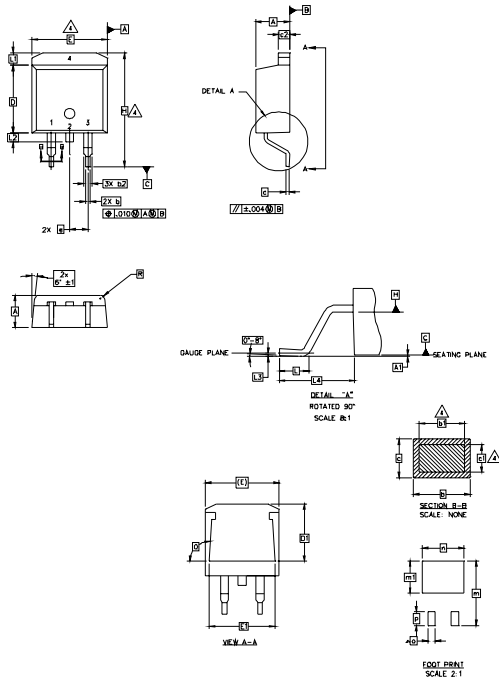
**Fig 14.** For N-channel HEXFET® power MOSFETs

# IRF3710S/IRF3710L

International  
**IR** Rectifier

## D<sup>2</sup>Pak Package Outline

Dimensions are shown in millimeters (inches)



- NOTES:
1. DIMENSIONING AND TOLERANCING PER ASME Y14.5M-1994
  2. DIMENSIONS ARE SHOWN IN MILLIMETERS (INCHES)
  3. DIMENSION D & E DO NOT INCLUDE MOLD FLASH. MOLD FLASH SHALL NOT EXCEED 0.127 (.005") PER SIDE. THESE DIMENSIONS ARE MEASURED AT THE OUTMOST EXTREMES OF THE PLASTIC BODY.
  4. DIMENSION b1 AND c1 APPLY TO BASE METAL ONLY.
  5. CONTROLLING DIMENSION: INCH.

SYMBOL	DIMENSIONS				NOTES
	MILLIMETERS		INCHES		
	MIN.	MAX.	MIN.	MAX.	
A	4.06	4.83	.160	.190	4
A1	0.00	0.254	.000	.010	
b	0.51	0.99	.020	.039	
b1	0.51	0.99	.020	.035	
b2	1.14	1.78	.045	.070	4
c	0.38	0.74	.015	.029	
c1	0.38	0.58	.015	.023	3
c2	1.14	1.65	.045	.065	
D	8.51	9.65	.335	.380	3
D1	6.86		.270		
E	9.65	10.67	.380	.420	3
E1	6.22		.245		
e	2.54 BSC		.100 BSC		IGBTs, CoPACK
H	14.61	15.88	.575	.625	
L	1.78	2.79	.070	.110	1.- GATE 2, 4.- COLLECTOR 3.- EMITTER
L1		1.65	.065		
L2	1.27	1.78	.050	.070	DIODES 1.- ANODE * 2, 4.- CATHODE 3.- ANODE
L3	0.25 BSC		.010 BSC		
L4	4.78	5.28	.188	.208	* PART DEPENDENT.
m	17.78		.700		
m1	8.89		.350		
n	11.43		.460		
o	2.08		.082		
p	3.81		.150		
R	0.51	0.71	.020	.028	
θ	90°	93°	90°	93°	

### LEAD ASSIGNMENTS

#### HEXFEET

- 1.- GATE
- 2, 4.- DRAIN
- 3.- SOURCE

#### IGBTs, CoPACK

- 1.- GATE
- 2, 4.- COLLECTOR
- 3.- EMITTER

#### DIODES

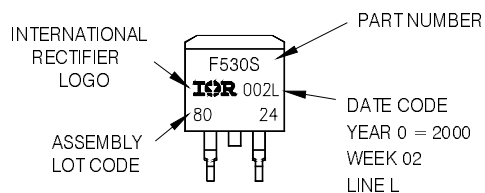
- 1.- ANODE \*
- 2, 4.- CATHODE
- 3.- ANODE

\* PART DEPENDENT.

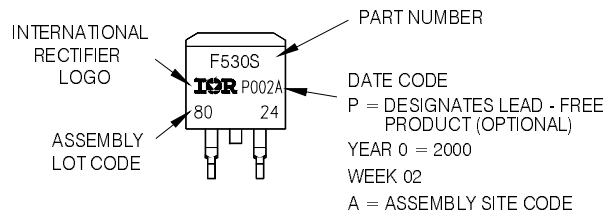
## D<sup>2</sup>Pak Part Marking Information

EXAMPLE: THIS IS AN IRF530S WITH  
LOT CODE 8024  
ASSEMBLED ON VW 02, 2000  
IN THE ASSEMBLY LINE "L"

Note: "P" in assembly line position  
indicates "Lead - Free"



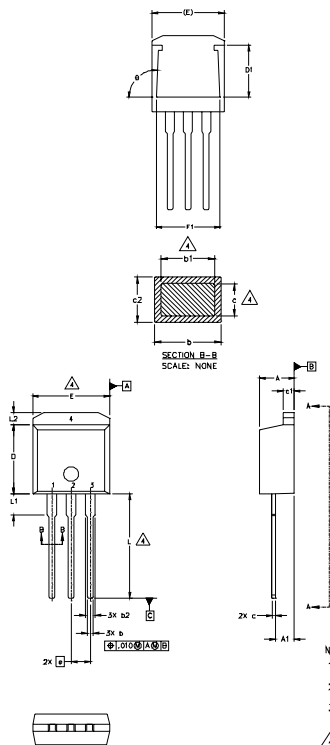
OR





## TO-262 Package Outline

Dimensions are shown in millimeters (inches)



SYMBOL	DIMENSIONS				NOTES
	MILLIMETERS		INCHES		
	MIN.	MAX.	MIN.	MAX.	
A	4.06	4.83	.160	.190	
A1	2.03	2.92	.080	.115	
b	0.51	0.99	.020	.039	4
b1	0.51	0.89	.020	.035	
b2	1.14	1.40	.045	.055	4
c	0.38	0.63	.015	.025	
c1	1.14	1.40	.045	.055	
c2	0.43	.063	.017	.029	
D	8.51	9.65	.335	.380	3
D1	5.33		.210		
E	9.65	10.67	.380	.420	3
E1	6.22		.245		
e	2.54 BSC		.100 BSC		
L	13.46	14.09	.530	.555	
L1	3.56	3.71	.140	.146	
L2		1.65		.065	

### LEAD ASSIGNMENTS

HEXFET	IGBT
1. - GATE	1 - GATE
2. - DRAIN	2 - COLLECTOR
3. - SOURCE	3 - EMITTER
4. - DRAIN	

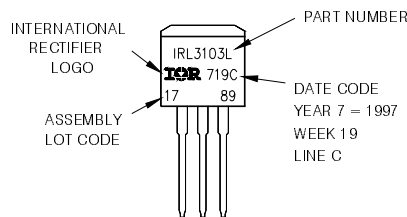
#### NOTES:

1. DIMENSIONING AND TOLERANCING PER ASME Y14.5M-1994
2. DIMENSIONS ARE SHOWN IN MILLIMETERS [INCHES]
3. DIMENSION D & E DO NOT INCLUDE MOLD FLASH. MOLD FLASH SHALL NOT EXCEED 0.127 [0.005"] PER SIDE. THESE DIMENSIONS ARE MEASURED AT THE OUTMOST EXTREMES OF THE PLASTIC BODY.
4. DIMENSION b1 AND c1 APPLY TO BASE METAL ONLY.
5. CONTROLLING DIMENSION: INCH.

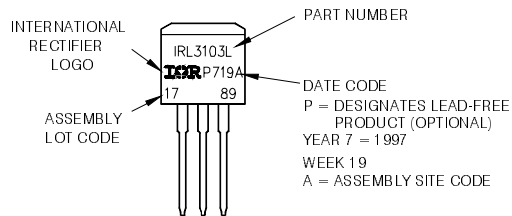
## TO-262 Part Marking Information

EXAMPLE: THIS IS AN IRL3103L  
 LOT CODE 1789  
 ASSEMBLED ON WW 19, 1997  
 IN THE ASSEMBLY LINE 'C'

Note: 'P' in assembly line position indicates 'Lead-Free'



**OR**

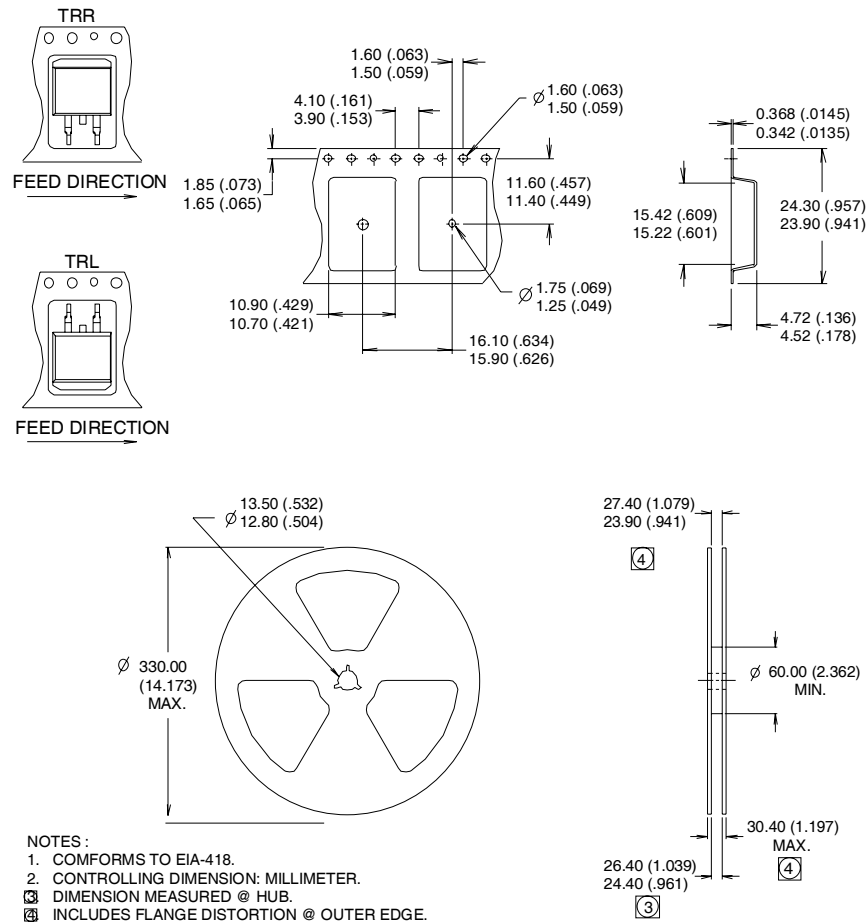


# IRF3710S/IRF3710L

International  
**IR** Rectifier

## D<sup>2</sup>Pak Tape & Reel Information

Dimensions are shown in millimeters (inches)



Data and specifications subject to change without notice.  
This product has been designed and qualified for the Industrial market.  
Qualification Standards can be found on IR's Web site.

International  
**IR** Rectifier

**IR WORLD HEADQUARTERS:** 233 Kansas St., El Segundo, California 90245, USA Tel: (310) 252-7105  
TAC Fax: (310) 252-7903

Visit us at [www.irf.com](http://www.irf.com) for sales contact information.03/05

[www.irf.com](http://www.irf.com)